

# SIEMENS

## SITRANS F

### Ultrasonic flowmeters SITRANS FST090

#### Operating Instructions

7NG313 (FST090)

Getting started	1
Introduction	2
Safety notes	3
Description	4
Installing/mounting	5
Connecting	6
Commissioning	7
Operating	8
Parameter assignment	9
Service and maintenance	10
Diagnostics and troubleshooting	11
Technical specifications	12
Dimension drawings	13
Modbus communication	A
Product documentation and support	B
Remote operation	C
HMI menu structure	D

## Legal information

### Warning notice system

This manual contains notices you have to observe in order to ensure your personal safety, as well as to prevent damage to property. The notices referring to your personal safety are highlighted in the manual by a safety alert symbol, notices referring only to property damage have no safety alert symbol. These notices shown below are graded according to the degree of danger.

 <b>DANGER</b>
indicates that death or severe personal injury <b>will</b> result if proper precautions are not taken.

 <b>WARNING</b>
indicates that death or severe personal injury <b>may</b> result if proper precautions are not taken.

 <b>CAUTION</b>
indicates that minor personal injury can result if proper precautions are not taken.

<b>NOTICE</b>
indicates that property damage can result if proper precautions are not taken.

If more than one degree of danger is present, the warning notice representing the highest degree of danger will be used. A notice warning of injury to persons with a safety alert symbol may also include a warning relating to property damage.

### Qualified Personnel

The product/system described in this documentation may be operated only by **personnel qualified** for the specific task in accordance with the relevant documentation, in particular its warning notices and safety instructions. Qualified personnel are those who, based on their training and experience, are capable of identifying risks and avoiding potential hazards when working with these products/systems.

### Proper use of Siemens products

Note the following:

 <b>WARNING</b>
Siemens products may only be used for the applications described in the catalog and in the relevant technical documentation. If products and components from other manufacturers are used, these must be recommended or approved by Siemens. Proper transport, storage, installation, assembly, commissioning, operation and maintenance are required to ensure that the products operate safely and without any problems. The permissible ambient conditions must be complied with. The information in the relevant documentation must be observed.

### Trademarks

All names identified by ® are registered trademarks of Siemens AG. The remaining trademarks in this publication may be trademarks whose use by third parties for their own purposes could violate the rights of the owner.

### Disclaimer of Liability

We have reviewed the contents of this publication to ensure consistency with the hardware and software described. Since variance cannot be precluded entirely, we cannot guarantee full consistency. However, the information in this publication is reviewed regularly and any necessary corrections are included in subsequent editions.

# Table of contents

<b>1</b>	<b>Getting started .....</b>	<b>7</b>
<b>2</b>	<b>Introduction.....</b>	<b>9</b>
2.1	Purpose of this documentation .....	9
2.2	Document history .....	9
2.3	Product compatibility.....	9
2.4	Checking the consignment.....	9
2.5	Items supplied .....	10
2.6	Designated use .....	10
2.7	Security information .....	11
2.8	Transportation and storage .....	12
2.9	Notes on warranty .....	12
<b>3</b>	<b>Safety notes.....</b>	<b>13</b>
3.1	Preconditions for use .....	13
3.1.1	Warning symbols on the device .....	13
3.1.2	Laws and directives.....	13
3.1.3	Conformity with European directives.....	14
3.1.4	Improper device modifications.....	14
3.2	Requirements for special applications.....	14
3.3	Battery powered devices .....	15
3.3.1	Lithium batteries.....	15
<b>4</b>	<b>Description.....</b>	<b>17</b>
4.1	Overview .....	17
4.2	Design .....	17
4.2.1	Transmitter .....	17
4.3	Features .....	18
<b>5</b>	<b>Installing/mounting .....</b>	<b>21</b>
5.1	Basic safety notes.....	21
5.1.1	Installation location requirements .....	22
5.1.2	Proper mounting.....	23
5.2	Application Guidelines .....	24
5.3	Disassembly.....	24
<b>6</b>	<b>Connecting .....</b>	<b>25</b>
6.1	Basic safety notes.....	25
6.1.1	Connecting or disconnecting in explosive environments .....	27

6.2	Transmitter wiring .....	29
6.3	Sensor wiring.....	30
6.4	Junction Box wiring.....	32
<b>7</b>	<b>Commissioning .....</b>	<b>37</b>
7.1	Basic safety notes.....	37
7.2	Power up .....	38
7.3	Device startup .....	39
7.4	Access control.....	40
7.5	Wizards.....	41
7.6	Comissioning with unknown sound velocity .....	42
<b>8</b>	<b>Operating.....</b>	<b>43</b>
8.1	Operating the device on the local display .....	43
8.1.1	Display views .....	43
8.1.2	Fixed display texts.....	45
8.1.3	Reading the process values .....	46
8.1.4	Operating the totalizer .....	48
8.1.5	Handling alarms.....	48
8.1.6	Reading the diagnostic values .....	50
8.2	Reading / changing parameters .....	50
8.2.1	Parameter view .....	50
8.2.2	Alphanumeric parameters .....	51
8.2.3	Parameter lists .....	53
<b>9</b>	<b>Parameter assignment.....</b>	<b>55</b>
9.1	Multipoint calibration .....	55
9.2	Inputs and outputs.....	57
9.2.1	Digital input.....	65
<b>10</b>	<b>Service and maintenance .....</b>	<b>67</b>
10.1	Basic safety notes.....	67
10.1.1	Maintenance.....	67
10.2	Cleaning .....	68
10.3	Maintenance and repair work.....	68
10.3.1	Removing or replacing the battery.....	70
10.3.2	Removing or replacing the SensorFlash microSD card .....	71
10.4	Transport.....	72
10.4.1	Transport with fitted battery.....	72
10.5	Return procedure .....	72
10.6	Disposal.....	73
<b>11</b>	<b>Diagnostics and troubleshooting.....</b>	<b>75</b>
11.1	Device status symbols .....	75

---

11.2	Device status symbols (chart).....	75
<b>12</b>	<b>Technical specifications .....</b>	<b>79</b>
12.1	Power .....	79
12.2	Inputs .....	79
12.3	Outputs .....	80
12.4	Construction .....	81
12.5	Operating conditions .....	82
12.6	Approvals .....	82
12.7	SensorFlash .....	82
<b>13</b>	<b>Dimension drawings .....</b>	<b>85</b>
<b>A</b>	<b>Modbus communication .....</b>	<b>87</b>
A.1	Modbus addressing model .....	87
A.2	Modbus function codes.....	87
A.3	Changing Modbus communication settings .....	92
A.4	Modbus communication .....	93
A.5	Coil configuration .....	94
A.6	Modbus register mapping .....	95
A.7	Integer byte order .....	97
A.8	Float byte order .....	97
A.9	Modbus function codes.....	98
A.10	Access control.....	99
<b>B</b>	<b>Product documentation and support .....</b>	<b>101</b>
B.1	Product documentation .....	101
B.2	Technical support.....	102
<b>C</b>	<b>Remote operation .....</b>	<b>103</b>
C.1	SIMATIC PDM .....	103
C.1.1	Overview SIMATIC PDM .....	103
C.1.2	Check SIMATIC PDM version .....	103
C.1.3	Updating the Electronic Device Description (EDD).....	104
<b>D</b>	<b>HMI menu structure.....</b>	<b>105</b>
	<b>Index.....</b>	<b>107</b>



# Getting started

## Condition

Before you start, read the following safety information:

- General safety information (Page 13)
- Basic safety information: Installing/mounting (Page 21)
- Basic safety information: Connecting (Page 25)
- Basic safety information: Commissioning (Page 37)

Read the entire document in order to achieve the optimum performance of the device.

## Procedure

1. Charge the battery.  
Transmitter wiring (Page 29)
2. Power up the device.  
Power up (Page 38)
3. Select access level "Expert" to be able to configure all parameters.  
Access control (Page 40)  
An overview of the menu structure can be found in an excel file:  
Menu structure (<https://support.industry.siemens.com/cs/document/109804533/menu-structure-of-the-sitrans-fst020-and-sitrans-fst090?dti=0&pnid=24980&lc=en-US>).
4. Mount the sensors as described in the FSS200 Installation Manual (<https://support.industry.siemens.com/cs/document/109777112/sitrans-fss200?dti=0&pnid=24498&lc=en-US>).
5. Connect the sensor cables.  
Sensor wiring (Page 30)





# Introduction

## 2.1 Purpose of this documentation

These instructions contain all information required to commission and use the device. Read the instructions carefully prior to installation and commissioning. In order to use the device correctly, first review its principle of operation.

The instructions are aimed at persons mechanically installing the device, connecting it electronically, configuring the parameters and commissioning it, as well as service and maintenance engineers.

## 2.2 Document history

The following table shows major changes in the documentation compared to the previous edition.

Edition	Remark
11/2021	First edition

## 2.3 Product compatibility

Edition	Remarks	Device revision	Compatible device revision integration package	
11/2021	First edition	Modbus FW: 2.02.00-06 HW: 1.01.01	SIMATIC PDM V8.2 SP1 or later	EDD: 1.00.00 or later

## 2.4 Checking the consignment

1. Check the packaging and the delivered items for visible damages.
2. Report any claims for damages immediately to the shipping company.

3. Retain damaged parts for clarification.
4. Check the scope of delivery by comparing your order to the shipping documents for correctness and completeness.

**⚠ WARNING**

**Using a damaged or incomplete device**

Risk of explosion in hazardous areas.

- Do not use damaged or incomplete devices.

## 2.5 Items supplied

- SITRANS FST090 ultrasonic transmitter



- Siemens Process Instrumentation documentation disk containing certificates, and manuals for ATEX approved devices



---

### Note

Scope of delivery may vary, depending on version and add-ons. Make sure the scope of delivery and the information on the nameplate correspond to your order and the delivery note.

---

## 2.6 Designated use

Use the device in accordance with the information on the nameplate and in the Technical specifications (Page 79).

**NOTICE****Use in a domestic environment**

This Class A Group 1 equipment is intended for use in industrial areas.

In a domestic environment this device may cause radio interference.

## 2.7 Security information

Siemens provides products and solutions with industrial security functions that support the secure operation of plants, systems, machines and networks.

In order to protect plants, systems, machines and networks against cyber threats, it is necessary to implement – and continuously maintain – a holistic, state-of-the-art industrial security concept. Siemens' products and solutions constitute one element of such a concept.

Customers are responsible for preventing unauthorized access to their plants, systems, machines and networks. Such systems, machines and components should only be connected to an enterprise network or the internet if and to the extent such a connection is necessary and only when appropriate security measures (e.g. firewalls and/or network segmentation) are in place.

For additional information on industrial security measures that may be implemented, please visit

<https://www.siemens.com/industrialsecurity>.

Siemens' products and solutions undergo continuous development to make them more secure. Siemens strongly recommends that product updates are applied as soon as they are available and that the latest product versions are used. Use of product versions that are no longer supported, and failure to apply the latest updates may increase customer's exposure to cyber threats.

To stay informed about product updates, subscribe to the Siemens Industrial Security RSS Feed under

<https://www.siemens.com/industrialsecurity>.

## 2.8 Transportation and storage

To guarantee sufficient protection during transport and storage, observe the following:

- Keep the original packaging for subsequent transportation.
- Devices/replacement parts should be returned in their original packaging.
- If the original packaging is no longer available, ensure that all shipments are properly packaged to provide sufficient protection during transport. Siemens cannot assume liability for any costs associated with transportation damages.

<b>NOTICE</b>
<b>Insufficient protection during storage</b> The packaging only provides limited protection against moisture and infiltration. <ul style="list-style-type: none"><li>• Provide additional packaging as necessary.</li></ul>

Special conditions for storage and transportation of the device are listed in Operating conditions (Page 82).

## 2.9 Notes on warranty

The contents of this manual shall not become part of or modify any prior or existing agreement, commitment or legal relationship. The sales contract contains all obligations on the part of Siemens as well as the complete and solely applicable warranty conditions. Any statements regarding device versions described in the manual do not create new warranties or modify the existing warranty.

The content reflects the technical status at the time of publishing. Siemens reserves the right to make technical changes in the course of further development.

## Safety notes

### 3.1 Preconditions for use

This device left the factory in good working condition. In order to maintain this status and to ensure safe operation of the device, observe these instructions and all the specifications relevant to safety.

Observe the information and symbols on the device. Do not remove any information or symbols from the device. Always keep the information and symbols in a completely legible state.

#### 3.1.1 Warning symbols on the device

Symbol	Explanation
	Consult operating instructions

#### 3.1.2 Laws and directives

Observe the safety rules, provisions and laws applicable in your country during connection, assembly and operation. These include, for example:

- National Electrical Code (NEC - NFPA 70) (USA)
- Canadian Electrical Code (CEC Part I) (Canada)

Further provisions for hazardous area applications are for example:

- IEC 60079-14 (international)
- EN 60079-14 (EU and UK)

### 3.1.3 Conformity with European directives

The CE marking on the device symbolizes the conformity with the following European directives:

Electromagnetic compatibility EMC 2014/30/EU	Directive of the European Parliament and of the Council on the harmonisation of the laws of the Member States relating to electromagnetic compatibility
Low voltage directive LVD 2014/35/EU	Directive of the European Parliament and of the Council on the harmonisation of the laws of the Member States relating to the making available on the market of electrical equipment designed for use within certain voltage limits
2011/65/EU RoHS	Directive of the European Parliament and the Council on the restriction of the use of certain hazardous substances in electrical and electronic equipment

The applicable directives can be found in the EU declaration of conformity of the specific device.

### 3.1.4 Improper device modifications

 <b>WARNING</b>
<b>Improper device modifications</b> Risk to personnel, system and environment can result from modifications to the device, particularly in hazardous areas. <ul style="list-style-type: none"><li>• Only carry out modifications that are described in the instructions for the device. Failure to observe this requirement cancels the manufacturer's warranty and the product approvals.</li></ul>

## 3.2 Requirements for special applications

Due to the large number of possible applications, each detail of the described device versions for each possible scenario during commissioning, operation, maintenance or operation in systems cannot be considered in the instructions. If you need additional information not covered by these instructions, contact your local Siemens office or company representative.

---

#### Note

##### Operation under special ambient conditions

We highly recommend that you contact your Siemens representative or our application department before you operate the device under special ambient conditions as can be encountered in nuclear power plants or when the device is used for research and development purposes.

---

## 3.3 Battery powered devices

### 3.3.1 Lithium batteries

Lithium batteries are primary power sources with high energy content designed to provide the highest possible degree of safety.



#### WARNING

##### Potential hazard

Lithium batteries may present a potential hazard if they are abused electrically or mechanically. Observe the following precautions when handling and using lithium batteries:

- Do not short-circuit, recharge or connect with false polarity.
- Do not expose to temperatures beyond the specified temperature range.
- Do not incinerate.
- Do not crush, puncture or open cells or disassemble.
- Do not weld or solder to the battery's body.
- Do not expose contents to water.
- Do not drop the battery.

3.3 Battery powered devices



## Description

### 4.1 Overview

SITRANS FST090 ultrasonic flow meter systems consist of a transmitter and a sensor. The following table lists the available combinations of transmitters and sensors.

Transmitter	Sensor type
FST090	FSS200 Clamp-on sensors for retrofitting on pipes DN 15 to DN 9000 (0.5" to 360") See FSS200 clamp-on sensors Installation Manual ( <a href="https://support.industry.siemens.com/cs/products?dtp=Manual&amp;mf=ps&amp;pnid=24498&amp;lc=en-WW">https://support.industry.siemens.com/cs/products?dtp=Manual&amp;mf=ps&amp;pnid=24498&amp;lc=en-WW</a> ).

### 4.2 Design

#### 4.2.1 Transmitter

The transmitter reads the measured process values from the sensor and calculates derived values. It provides Modbus communications, 1x 4-20 mA, 1x relay, 2x digital inputs for totalizer start/stop and reset and 1x Pulse/Frequency, USB service port, and a local display. It also adds functionalities such as totalizers, access control, diagnostics, and configuration. The local user interface consists of a display and four buttons for user interaction.

The transmitter has a modular design with discrete, replaceable electronic modules and connection boards to maintain separation between functions and facilitate field service. All modules are fully traceable and their provenance is included in the transmitter setup.

The SITRANS FST090 is available as:

### FST090



Figure 4-1 FST090 IP67

## 4.3 Features

- Polycarbonate IP67 portable enclosure
- Full graphical local display
- SensorFlash (SD card) for memory backup, Datalogger and documentation storage (certificates etc.)
- USB service interface
- Modbus communications
- One pulse/frequency output
- One relay
- One Digital Input for totalizer start/stop
- One Digital Input for totalizer reset
- One current output 4-20 mA
- High immunity against process noise
- Fast response to step changes in flow
- High update rate (100 Hz) on all process values
- Measurement of:
  - Volume flow
  - Mass flow (with fixed density setpoint)
  - Flow velocity
  - Sound velocity
- Configurable upper and lower alarms and warning limits for nearly all process values
- Independent low flow cut-off settings for volume flow and mass flow

- Zero-point adjustment
- Process noise damping using digital signal processing (DSP)
- Simulation of process values
- Simulation of all outputs
- Simulation of alarms
- Enabling alarms for visibility on all outputs (HMI, status and communication)
- Comprehensive diagnostics (Siemens standard) for troubleshooting and sensor checking
- Firmware update
- Data logging in SensorFlash
- Peak indicators
- Alarm delay



# Installing/mounting

## 5.1 Basic safety notes

 <b>DANGER</b>
<b>Pressure applications</b> Danger to personnel, system and environment will result from improper disassembly. <ul style="list-style-type: none"><li>• Never attempt to loosen, remove, or disassemble process connection while vessel contents are under pressure.</li></ul>

 <b>WARNING</b>
<b>Wetted parts unsuitable for the process media</b> Risk of injury or damage to device. Hot, toxic and corrosive media could be released if the wetted parts are unsuitable for the process medium. <ul style="list-style-type: none"><li>• Ensure that the material of the device parts wetted by the process medium is suitable for the medium. Refer to the information in Technical specifications (Page 79).</li></ul>

---

**Note****Material compatibility**

Siemens can provide you with support concerning selection of sensor components wetted by process media. However, you are responsible for the selection of components. Siemens accepts no liability for faults or failures resulting from incompatible materials.

---

 <b>WARNING</b>
<b>Unsuitable connecting parts</b> Risk of injury or poisoning. In case of improper mounting, hot, toxic, and corrosive process media could be released at the connections. <ul style="list-style-type: none"><li>• Ensure that connecting parts (such as flange gaskets and bolts) are suitable for connection and process media.</li></ul>

**See also**

Technical specifications (Page 79)

 <b>WARNING</b>
<b>Exceeded maximum permissible operating pressure</b>
Risk of injury or poisoning.
The maximum permissible operating pressure depends on the device version, pressure limit and temperature rating. The device can be damaged if the operating pressure is exceeded. Hot, toxic and corrosive process media could be released.
Ensure that maximum permissible operating pressure of the device is not exceeded. Refer to the information on the nameplate and/or in Technical specifications (Page 79).

 <b>CAUTION</b>
<b>Hot surfaces resulting from hot process media</b>
Risk of burns resulting from surface temperatures above 65 °C (149 °F).
<ul style="list-style-type: none"><li>• Take appropriate protective measures, for example contact protection.</li><li>• Make sure that protective measures do not cause the maximum permissible ambient temperature to be exceeded. Refer to the information in Technical specifications (Page 79).</li></ul>

 <b>CAUTION</b>
<b>External stresses and loads</b>
Damage to device by severe external stresses and loads (e.g. thermal expansion or pipe tension). Process media can be released.
<ul style="list-style-type: none"><li>• Prevent severe external stresses and loads from acting on the device.</li></ul>

### 5.1.1 Installation location requirements

 <b>WARNING</b>
<b>Insufficient air supply</b>
The device may overheat if there is an insufficient supply of air.
<ul style="list-style-type: none"><li>• Install the device so that there is sufficient air supply in the room.</li><li>• Observe the maximum permissible ambient temperature. Refer to the information in the section Technical specifications (Page 79).</li></ul>

<b>NOTICE</b>
<b>Aggressive atmospheres</b> Damage to device through penetration of aggressive vapors. <ul style="list-style-type: none"><li>• Ensure that the device is suitable for the application.</li></ul>

<b>NOTICE</b>
<b>Direct sunlight</b> Damage to device. The device can overheat or materials become brittle due to UV exposure. <ul style="list-style-type: none"><li>• Protect the device from direct sunlight.</li><li>• Make sure that the maximum permissible ambient temperature is not exceeded. Refer to the information in Technical specifications (Page 79).</li></ul>

<b>NOTICE</b>
<b>Strong vibrations</b> Damage to device. <ul style="list-style-type: none"><li>• In installations with strong vibrations, mount the transmitter in a low vibration environment.</li></ul>

### 5.1.2 Proper mounting

<b>NOTICE</b>
<b>Incorrect mounting</b> The device can be damaged, destroyed, or its functionality impaired through improper mounting. <ul style="list-style-type: none"><li>• Before installing ensure there is no visible damage to the device.</li><li>• Make sure that process connectors are clean, and suitable gaskets and glands are used.</li><li>• Mount the device using suitable tools. Refer to the information in Technical specifications (Page 79).</li></ul>

## 5.2 Application Guidelines

### Basic Requirements

For a more comprehensive guide on how to install the sensor read the FSS200 Installation Manual (<https://support.industry.siemens.com/cs/document/109777112/sitrans-fss200?dti=0&pnid=24498&lc=en-US>).

- Determine pipe material and dimensions.
- Avoid vertical pipes flowing in a downward direction.
- Avoid installation of sensors on the top and bottom of horizontal pipes, if possible.
- Select a location with the longest straight run of pipe.
- Identify upstream piping configuration (elbow, reducer, etc.).
- Pipe surface should be smooth and, if necessary, free of paint.
- Avoid pressure reduction components upstream.
- Avoid mounting on or near weld seams.
- Pipe must be full to achieve proper operation.

## 5.3 Disassembly

### WARNING

#### Incorrect disassembly

The following risks may result from incorrect disassembly:

- Injury through electric shock
- Risk through emerging media when connected to the process
- Risk of explosion in hazardous area

In order to disassemble correctly, observe the following:

- Before starting work, make sure that you have switched off all physical variables such as pressure, temperature, electricity etc. or that they have a harmless value.
- If the device contains hazardous media, it must be emptied prior to disassembly. Make sure that no environmentally hazardous media are released.
- Secure the remaining connections so that no damage can result if the process is started unintentionally.





# Connecting

## 6.1 Basic safety notes

 <b>WARNING</b>
<b>Unsuitable cables, cable glands and/or plugs</b> Risk of explosion in hazardous areas. <ul style="list-style-type: none"><li>• Use only cable glands/plugs that comply with the requirements for the relevant type of protection.</li><li>• Tighten the cable glands in accordance with the torques specified in Construction (Page 81).</li><li>• Close unused cable inlets for the electrical connections.</li><li>• When replacing cable glands, only use cable glands of the same type.</li><li>• After installation, check that the cables are seated firmly.</li></ul>

 <b>WARNING</b>
<b>Incorrect conduit system</b> Risk of explosion in hazardous areas as result of open cable inlet or incorrect conduit system. <ul style="list-style-type: none"><li>• In the case of a conduit system, mount a spark barrier at a defined distance from the device input. Observe national regulations and the requirements stated in the relevant approvals.</li></ul>

 <b>WARNING</b>
<b>Hazardous contact voltage</b> Risk of electric shock in case of incorrect connection. <ul style="list-style-type: none"><li>• For the electrical connection specifications, refer to the information in Technical specifications (Page 79).</li><li>• At the mounting location of the device observe the applicable directives and laws for installation of electrical power installations with rated voltages below 1000 V.</li></ul>

 <b>WARNING</b>
<b>Missing PE/ground connection</b>
Risk of electric shock.
Depending on the device version, connect the power supply as follows:
<ul style="list-style-type: none"><li>• <b>Power plug:</b> Ensure that the used socket has a PE/ground conductor connection. Check that the PE/ground conductor connection of the socket and power plug match each other.</li><li>• <b>Connecting terminals:</b> Connect the terminals according to the terminal connection diagram. First connect the PE/ground conductor.</li></ul>

 <b>WARNING</b>
<b>Improper power supply</b>
Risk of explosion in hazardous areas as result of incorrect power supply.
<ul style="list-style-type: none"><li>• Connect the device in accordance with the specified power supply and signal circuits. The relevant specifications can be found in the certificates, in Technical specifications (Page 79) or on the nameplate.</li></ul>

 <b>WARNING</b>
<b>Lack of equipotential bonding</b>
Risk of explosion through compensating currents or ignition currents through lack of equipotential bonding.
<ul style="list-style-type: none"><li>• Ensure that the device is potentially equalized.</li></ul>
<b>Exception:</b> It may be permissible to omit connection of the equipotential bonding for devices with type of protection "Intrinsic safety Ex i".

 <b>WARNING</b>
<b>Unprotected cable ends</b>
Risk of explosion through unprotected cable ends in hazardous areas.
<ul style="list-style-type: none"><li>• Protect unused cable ends in accordance with IEC/EN 60079-14.</li></ul>

 <b>WARNING</b>
<b>Improper laying of shielded cables</b>
Risk of explosion through compensating currents between hazardous area and the non-hazardous area.
<ul style="list-style-type: none"><li>• Shielded cables that cross into hazardous areas should be grounded only at one end.</li><li>• If grounding is required at both ends, use an equipotential bonding conductor.</li></ul>

 **WARNING****Uncovered non-intrinsically safe circuits**

Risk of explosion in hazardous areas or electric shock when working on non-intrinsically safe circuits.

If intrinsically safe and non-intrinsically safe circuits are operated in an enclosure with the type of protection "Increased safety Ex e", the connections of the non-intrinsically safe circuits must be additionally covered.

- Ensure that the cover of the non-intrinsically safe circuits complies with degree of protection IP30 or higher according to IEC/EN 60529.
- Separate connections of the non-intrinsically safe circuits in accordance with IEC/EN 60079-14.

 **WARNING****Insufficient isolation of intrinsically safe and non-intrinsically safe circuits**

Risk of explosion in hazardous areas.

- When connecting intrinsically safe and non-intrinsically safe circuits ensure that isolation is carried out properly in accordance with local regulations for example IEC 60079-14.
- Ensure that you observe the device approvals applicable in your country.

## 6.1.1 Connecting or disconnecting in explosive environments

 **WARNING****Connecting or disconnecting in explosive environments**

Connecting or disconnecting a powered device in explosive environments can lead to an explosion.

- Connect and disconnect in **non**-explosive environments.  
- or -
- Remove power to the device before connecting or disconnecting in explosive atmosphere.

 <b>WARNING</b>
<b>Connecting or disconnecting device in energized state</b>
Risk of explosion in hazardous areas.
<ul style="list-style-type: none"><li>• Connect or disconnect devices in hazardous areas only in a de-energized state.</li><li>• Install a suitable switch-off device.</li></ul>
<b>Exceptions:</b>
<ul style="list-style-type: none"><li>• Devices having the type of protection "Intrinsic safety Ex i" may also be connected in energized state in hazardous areas.</li></ul>

 <b>WARNING</b>
<b>Incorrect selection of type of protection</b>
Risk of explosion in areas subject to explosion hazard.
This device is approved for several types of protection.
<ol style="list-style-type: none"><li>1. Decide in favor of one type of protection.</li><li>2. Connect the device in accordance with the selected type of protection.</li><li>3. In order to avoid incorrect use at a later point, make the types of protection that are not used permanently unrecognizable on the nameplate.</li></ol>

<b>NOTICE</b>
<b>Condensation in the device</b>
Damage to device through formation of condensation if the temperature difference between transportation or storage and the mounting location exceeds 20 °C (36 °F).
<ul style="list-style-type: none"><li>• Before taking the device into operation, let the device adapt for several hours in the new environment.</li></ul>

---

**Note**

**Electromagnetic compatibility (EMC)**

You can use this device in industrial environments, households and small businesses.

For metal enclosures there is an increased electromagnetic compatibility compared to high-frequency radiation. This protection can be increased by grounding the enclosure.

---

**See also**

Basic safety notes (Page 25)

**Note****Improvement of interference immunity**

- Lay signal cables separate from cables with voltages > 60 V.
- Use cables with twisted wires.
- Keep device and cables at a distance from strong electromagnetic fields.
- Take account of the conditions for communication specified in the Technical specifications (Page 79).
- Use shielded cables to guarantee the full specification according to HART/PA/FF/Modbus/EIA-485/Profibus DP.

## 6.2 Transmitter wiring

### Charging the battery

**Note****Charge battery prior to first use**

On delivery the battery level will be low. It is recommended to fully charge the battery prior to first use.

**Note****Ambient temperature**

The ambient temperature for charging the battery has to remain in the range of 0 °C to 40 °C.

1. Remove the battery. (Page 70)
2. Plug the battery into the charger.
3. Connect the AC Power Cord to the battery charger.
4. Plug the AC Power Cord into an AC power outlet.

LED	Indicator
One time Red/Orange/Green	Selftest: Charger is ready for use.
Red/Green blinking	Battery recognition and initialization.
Orange light	The inserted battery is of the correct type and is currently being charged.
Green light	The battery is charged and can be removed for use.
Red blinking	The battery is too hot or too cold to be charged without damage. If the battery is too cold it will be charged as soon as it has warmed up sufficiently. If the battery is too hot it should be removed to cool down.
Red light	The battery is damaged or it is a conventional battery which cannot be recharged.

### Connecting the Auxiliary Power Adapter

1. Connect the AC Power Cord to the AC Cord Input of the power supply.
2. Remove the cap on the Auxiliary Power Input socket by turning it counter clockwise.
3. Connect the Power Adapter connector into the rear panel Auxiliary Power Input socket.
4. Plug the AC Power Cord into an AC power outlet.

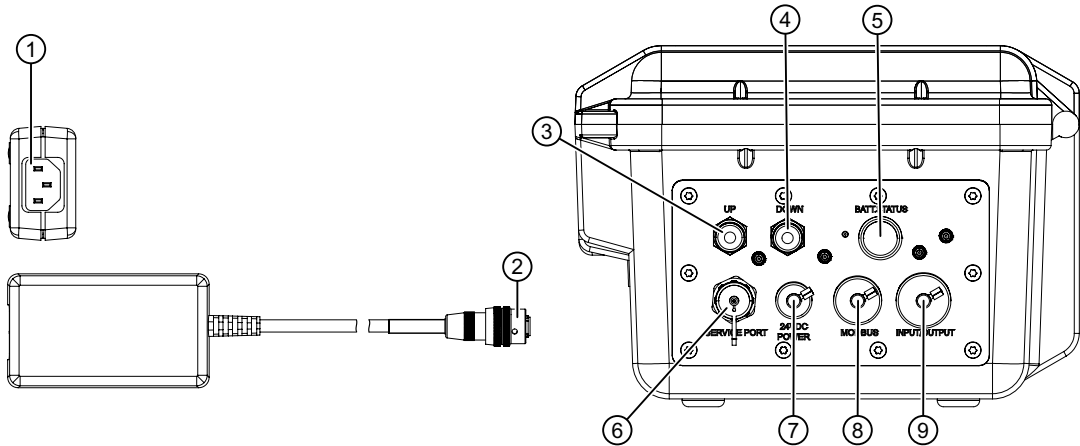

- |   |                          |
|---|--------------------------|
| ① AC Cord Input                               | ⑥ Service Port           |
| ② Connect to Rear Panel Power Input Connector | ⑦ Auxiliary Power Input  |
| ③ Flow Sensor Channel 1 - Upstream (BNC)      | ⑧ Modbus Connector       |
| ④ Flow Sensor Channel 1 - Downstream (BNC)    | ⑨ Input/Output Connector |
| ⑤ Battery Status Indicator                    |                          |

Figure 6-1 AC power and connections

### Battery Status Indicator LED

A battery status indicator shows the status of its internal battery. The indicator LED lights red while running on low battery.

LED	Battery Condition
ON	Battery below ~10-20% depending on temperature and battery health.
OFF	Running on external power source or remaining battery >~10-20%.

## 6.3 Sensor wiring

### Before you connect the sensor cable

Make sure you have Installed the sensors as described in the FSS200 Installation Manual (<https://support.industry.siemens.com/cs/document/109777112/sitrans-fss200?dti=0&pnid=24498&lc=en-US>).

## Connecting the sensor cable

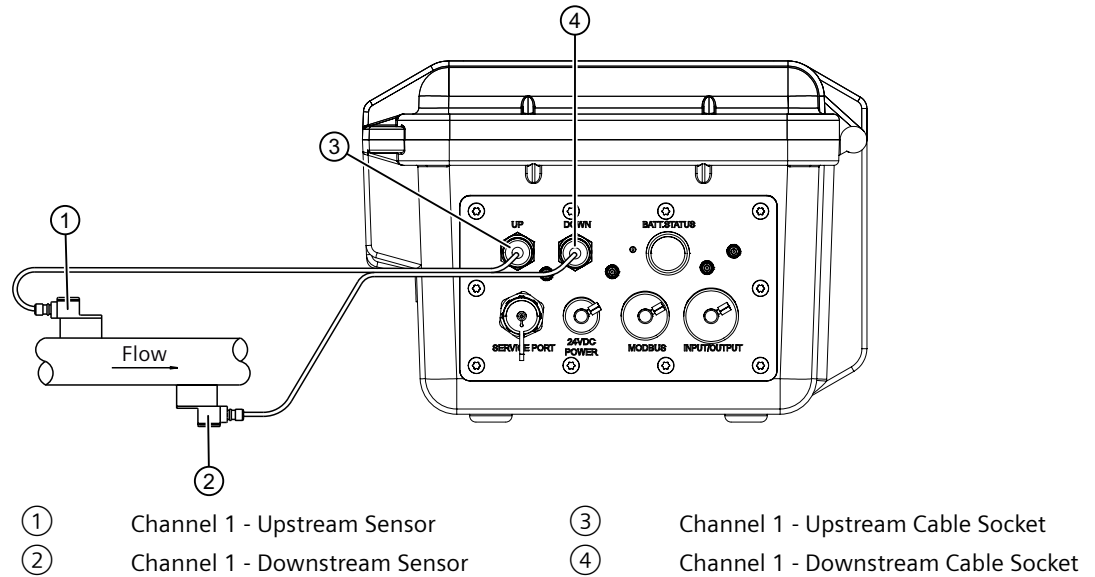

Figure 6-2 Direct mount connection example

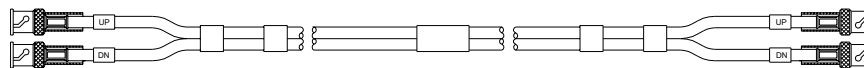

Figure 6-3 Sensor cable

1. Remove the caps on the upstream and downstream cable sockets by turning them counter clockwise.
2. Connect the sensor cable plugs with the "UP" markings to the upstream sensor and to the upstream cable socket on the transmitter.
3. Connect the sensor cable plugs with the "DN" markings to the downstream sensor and to the downstream cable socket on the transmitter.

# 6.4 Junction Box wiring

## Function of the Junction Box

The Junction Box is an optional device used for bus connections. The Junction Box can be ordered with order number: A5E50738825 under PIA Life Cycle Portal (<https://www.pia-portal.automation.siemens.com>).

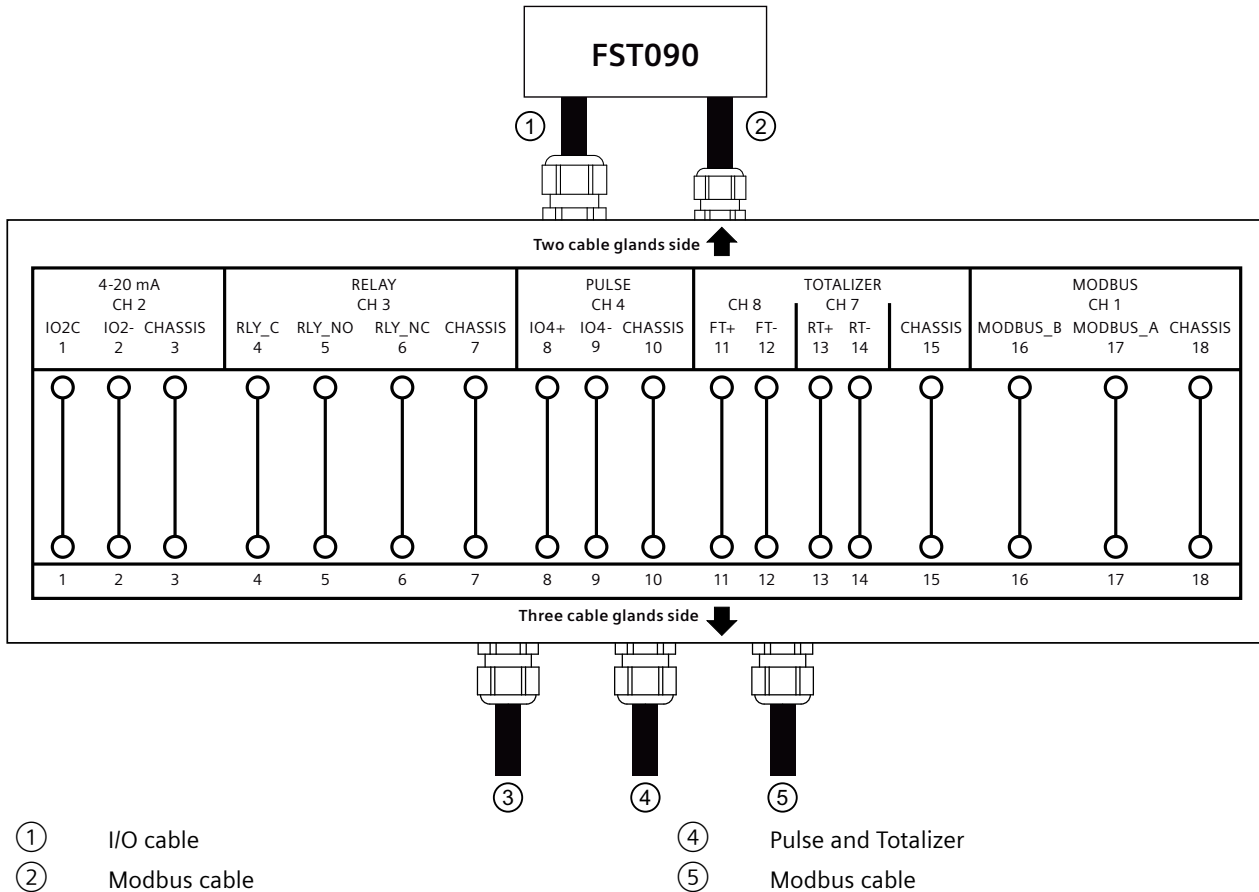

Figure 6-4 Junction Box wire diagram

Table 6-1 Input/Output Wiring

Pin#	Signal	Function	Description
1	Io2C	Isolated Loop Supply	Spannable 4-20mA output (Loop Powered). This output also provides a fault indication by dropping to 2mA if assigned to flow rate and under fault conditions.
2	Io2-	Isolated Loop Return	
3	Chassis	Ground	Ground
4	RLY_C	Relay Common	Relay Output
5	RLY_NO	Relay Normally Open	Relay Output
6	RLY_NC	Relay Normally Closed	Relay Output



Pin#	Signal	Function	Description
7	Chassis	Ground	Ground
8	Io4+	Transistor	Menu selection: PGEN, POS TOTAL, NEG TOTAL
9	Io4-	Transistor	
10	Chassis	Ground	Ground
11	FT+	DIGITAL INPUT +	Freezes Totalizer to stop incrementing.
12	FT-	DIGITAL INPUT -	
13	RT+	DIGITAL INPUT +	Clears Totalizer
14	RT-	DIGITAL INPUT -	
15	Chassis	Ground	Ground
16	Modbus_B	Differential +	Serial communication, Modbus protocol
17	Modbus_A	Differential -	Serial communication, Modbus protocol
18	Chassis	Ground	Ground

### Connecting FST090 to the Junction Box (two cable gland side)

1. Open the Junction Box cover.
2. Strip the cable jackets as shown.

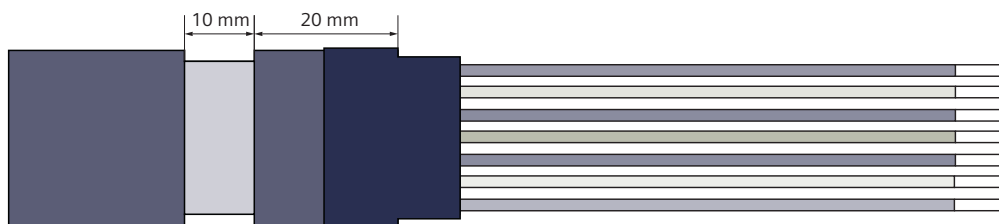

Figure 6-5 Stripped cable (amount of wires differs)

3. Push cable through nut and clamping insert. Assemble the shield ring on the cable shield.
4. Push cable through adapter and locknut.
5. Push the labeled solid wires into the connectors according to the wire diagram on the Junction Box cover.
6. Tighten cable glands.

### Connecting peripherals to the Junction Box (three cable gland side)

#### Note

#### Use solid wire cables or end sleeves

Make sure to use solid wire cables or end sleeves. Otherwise you will not be able to push the wires into the connectors.

#### Note

#### Cables must be shielded

Only use shielded cables with an outer diameter between 4-8 mm.

1. Open the Junction Box cover.
2. Strip the cable jackets as shown.

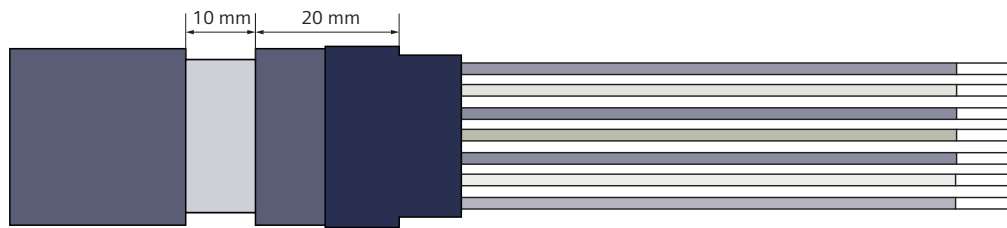
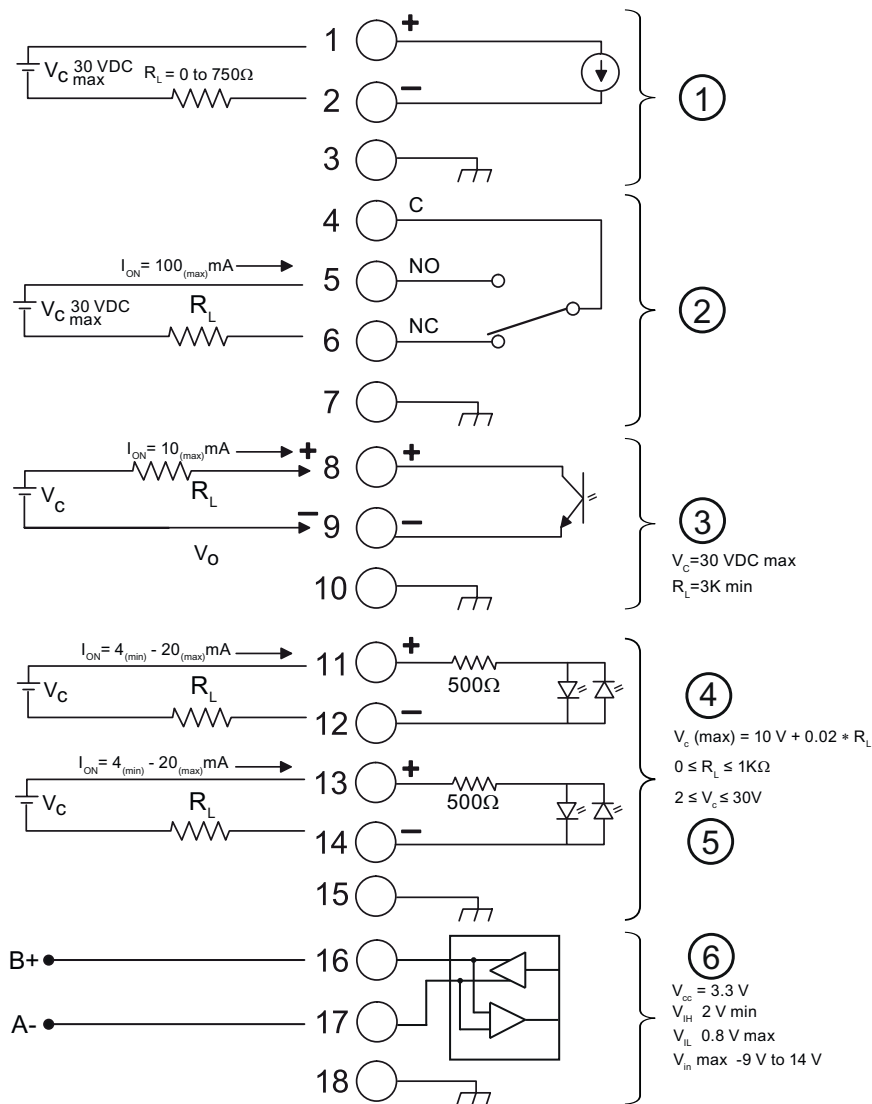

Figure 6-6 Stripped cable (amount of wires differs)

3. Push cable through nut and clamping insert. Assemble the shield ring on the cable shield.
4. Push cable through adapter and locknut.
5. Push the labeled solid wires into the connectors according to the wire diagram on the Junction Box cover.
6. Tighten cable glands.

Typical Junction Box wiring



- ① 4-20 mA output (current source)
- ② Relay output
- ③ Pulse output - polarity needs to be inverted
- ④ Digital input (Freeze TOT)
- ⑤ Digital input (CLR TOT)
- ⑥ Modbus

Figure 6-7 Typical Junction Box wiring

Connect pulse output to galvanically isolated input

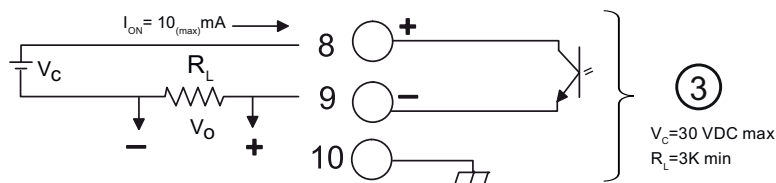

Figure 6-8 Alternative pulse output connection with galvanically isolated input

If the input is galvanically isolated the polarity does not need to be inverted.

Isolated 4-20 mA Output TB1-1/2	
R	= 250 $\Omega$ typical, 750 $\Omega$ maximum
$V_c$	= 24 VDC typical / 30 VDC maximum
I	= 4-20 mA
$R_L$	= Loop wire resistance (both ways) plus User's input load resistance.

Pulse output TB1-8 / TB1-9	
$V_c$	= +30 VDC max.
$R_L$	= 3K $\Omega$ minimum

Digital Inputs TB1-11 / TB1-12 and TB1-13 / TB1-14	
$V_c$	= (10V + 0.02 x RL) max. $2 \leq V_c \leq 30$ VDC
$0 \leq R_L \leq 1000 \Omega$	

**Activate or deactivate digital input on channel 7 (freeze totalizer) or channel 8 (clear totalizer)**

1. Apply voltage  $V_c$  according to your wiring to activate function on channel 7 or channel 8.
2. Apply short circuit between pins to deactivate function.

# Commissioning

This chapter gives instructions to commissioning your device, see Power up (Page 38).  
Furthermore, the device can be commissioned using SIMATIC PDM, see SIMATIC PDM (Page 103).

## 7.1 Basic safety notes

 <b>WARNING</b>
<b>Commissioning and operation with pending error</b>
If an error message appears, correct operation in the process is no longer guaranteed.
<ul style="list-style-type: none"><li>• Check the gravity of the error.</li><li>• Correct the error.</li><li>• If the error still exists:<ul style="list-style-type: none"><li>– Take the device out of operation.</li><li>– Prevent renewed commissioning.</li></ul></li></ul>

 <b>WARNING</b>
<b>Hazardous contact voltage</b>
Risk of injury through hazardous contact voltage when the device is open or not completely closed.
The degree of protection specified on the nameplate or in Technical specifications (Page 79) is no longer guaranteed if the device is open or not properly closed.
<ul style="list-style-type: none"><li>• Make sure that the device is securely closed.</li></ul>

### See also

Installing/mounting (Page 21)

## 7.2 Power up

### Before you power up

Make sure you have Installed the sensors as described in the FSS200 Installation Manual (<https://support.industry.siemens.com/cs/document/109777112/sitrans-fss200?dti=0&pnid=24498&lc=en-US>).

Make sure you have connected the sensor cables as described in Sensor wiring (Page 30).

### Powering up

1. Open the lid by lifting both latches.
2. Press the Power button.

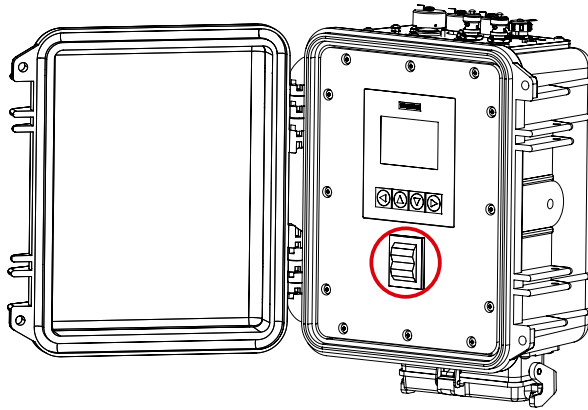
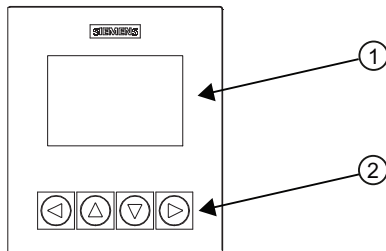

Figure 7-1 Power button location

The device is commissioned/operated with the touch keypad on the local display.

The graphic display above the keypad gives a menu-guided operation of the individual device function/parameters. Successful operation of the key is confirmed by tactile feedback as key is pressed.



- ① Full graphical display
- ② Touch keypad

Figure 7-2 Local display

---

**Note**

**HMI timeout**

If no key is pressed for 10 minutes, the display switches to show operation view. If Backlight is set to Automatic, display backlight goes off automatically 30 seconds after the last key press.

---

## 7.3 Device startup

### Condition

You have read the Basic safety notes (Page 37).

### Procedure

1. Power-on the device.  
For an initial startup, prompts for each of the following steps appear after power-on.
2. Set the language.  
The first time the device is configured, you will be prompted to set the language. The parameter "Language" always appears in English. To change the language after initial setup, access menu item 6.
3. Set the date and time.  
The correct date and time should be set prior to configuring the device.
4. Run the "Quick commissioning wizard".  
Essential parameters should be considered before using the device for the first time.
  - Choose "Yes" (recommended) to start the "Quick commissioning" wizard.
  - Choose "No", you accept the default values of the device (no sensors are configured).  
The next HMI view will be the operation view 1.

For any subsequent startup, after power-on, the device automatically starts in operation view. A transition screen showing first the Siemens logo and then the current firmware revision of the product is displayed while the first measurement is being processed.

## 7.4 Access control

You can view all items in the HMI menu but the parameters are protected against changes through access level control. To gain access, select one of the following access levels:

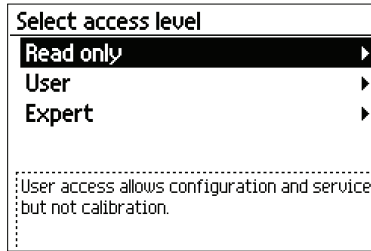

- Read only  
Allows no configuration. The parameter values can be viewed only (indicated by a  symbol). No PIN code required.
- User  
Allows configuration and service of all parameters except calibration parameters. Default PIN code is 2457.
- Expert  
Allows configuration and service of all parameters including flow and calibration parameters. Default PIN code is 2834.

PIN codes can be changed in **Security** (5).

---

### Note

#### Lost PIN code

If the PIN code is lost, provide Siemens customer support with the transmitter serial number (see nameplate). Siemens customer support will provide a code to be entered in PIN recovery (5.3).

---

### Disable access level control

If logged in as Expert you can **Deactivate user PIN**. As User you will not be prompted to enter the password. Enabling the access level control can be done in **Activate user PIN** and requires entering the Expert password.

### Auto logout function

You will **not** be prompted for password for 10 minutes after the last key press.

<b>NOTICE</b>
<b>Device restart</b>
Whenever the device is restarted, the access level is reset to Read only.



## 7.5 Wizards

The first view in each wizard (About - view 1) is a description of what settings/actions can be performed using the specific wizard.

The last view in each wizard (Finished) shows that the last step of the wizard was completed.

Any parameter changes confirmed with  are saved immediately.

At any time in any wizard selecting Exit will bring you back to the main wizard menu without discarding changes.

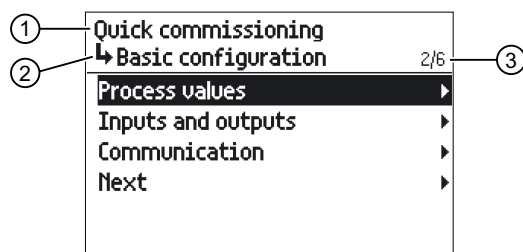

- ① Wizard name
- ② Step name / Parameter name
- ③ View number / Total views in wizard

The purpose of the wizards is to guide you through a quick set-up of various parameters.

The following HMI wizards are available:

- Quick commissioning
- Sensor settings







Use the  and  buttons to highlight the desired wizard and press right key to enter the wizard. The first view shows a short description of which settings can be done.

Table 7-1 Button functions - wizards

Button	Function
	Leave menu without saving changes
	Scroll up in list of options/change parameter value
	Scroll down in list of options/change parameter value
	First button press: Select option. Second button press: Confirm selection and save setting. When you reach the end of the wizard, e.g. "The Process values wizard is now finished.": return to wizard list

## 7.6 Commissioning with unknown sound velocity

### Procedure

1. Go through the "Quick commissioning" wizard and use your best estimate of the sound velocity for your medium.
2. Install the transducers according to what the transmitter calculates.
3. Note down the measured sound velocity from the measurement view.  
If the measured sound velocity deviates by more than 5% or 50 m/s from your estimation, the mounting method and spacing might have to be changed.
4. To make the corrections, first adjust the sound velocity through the "Quick commissioning" wizard or menu number 2.1.4.2.
5. Correct the installation of the transducers according to the new calculations.
6. If the measured sound velocity still deviates by more than 5% or 50 m/s from the value entered in step 4, repeat the procedure starting from step 3.

# Operating

## 8.1 Operating the device on the local display

### 8.1.1 Display views

There are three view types:

- **Operation view**

The operation views are fully configurable to show different process values in different operation view types. Depending on the operation view type configuration the view is one of the following:

- Reading the process values (Page 46): Show the measurement values.
- Handling alarms (Page 48): Show the active alarms in a list.
- Operating the totalizer (Page 48): Enable the totalizer reset.
- Reading the diagnostic values (Page 50): Show six configurable measurement/diagnostic values.

- **Parameter view**

The Parameter view (Page 50) shows the menus and parameters. The parameter view is used to navigate through the menus and parameters in the device.

- **Edit view**

The Edit view can be entered from the parameter view. The edit view is used to edit the parameters.

8.1 Operating the device on the local display

Navigating in the views

The following graphic shows an example of how to navigate between operation views and alarm views.

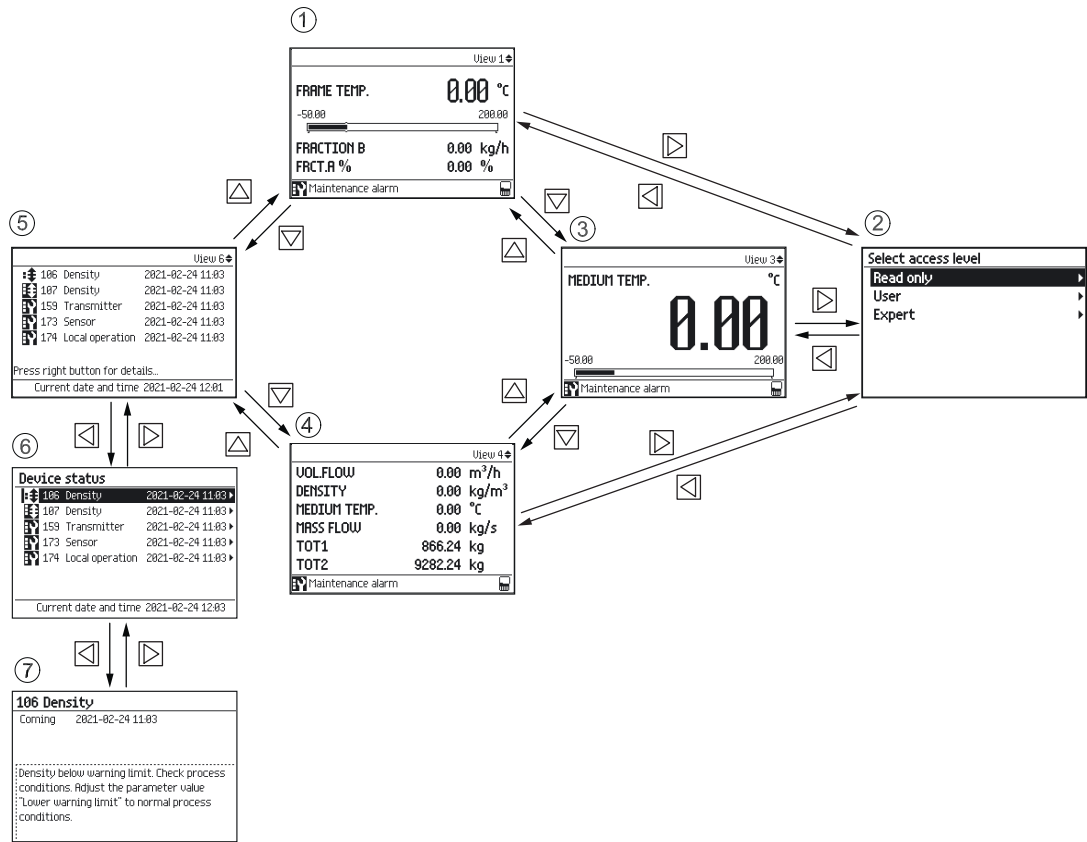

- ① Operation view
- ② Access level view
- ③ Operation view
- ④ Operation view
- ⑤ Alarm view - level 1
- ⑥ Alarm view - level 2
- ⑦ Alarm view - level 3

You can navigate through the menu structure items in the device using the four buttons on the display as described below.

Table 8-1 Key functions - menu structure navigation

Key	Function
	Return to previous item.
	Select the item above.

Key	Function
<input type="checkbox"/>	Select the item below.
<input type="checkbox"/>	Enter the selected item.

## 8.1.2 Fixed display texts

Some displayed texts are fixed, which means they will not change regardless of changed display language.

The following tables list the fixed display texts and their corresponding process value, diagnostic value, and compensation value names.

Table 8-2 Process values

Fixed display text	Process value name
VOL.FLOW	Volume flow
MASS FLOW	Mass flow
FLOW VEL	Flow velocity
SOUND VEL	Sound velocity
DENSITY	Density (Fixed value)
KIN. VISCOSITY	Kinematic viscosity (Fixed value)
FLUID TEMP.	Medium temperature (Fixed value)
TOT1	Totalizer 1

Table 8-3 Diagnostic values





Fixed display text	Diagnostic value name
TRN TEMP.	Transmitter internal temperature
CURR. OUT (CH2)	Ch2 value
REYNOLDS NO.	Reynolds number
P1.SNR UP	SNR up path 1
P1.SNR DOWN	SNR down path 1
P1.SOUND VEL	Sound velocity path 1
P1.DELTA TIME	Delta time path 1
P1.ACC.BURST	Path 1 percentage of bursts accepted
P1.PEAK AMP.DN	Peak amplitude down path 1
P1.PEAK AMP.UP	Peak amplitude up path 1

### 8.1.3 Reading the process values

The value of the process values can be displayed either as one or more numeric values or as numeric value(s) in combination with a graph/bargraph. The following view types are available:

- Single value
- Three values
- Totalizer
- 1 value and graph
- 1 value and bargraph
- Six values

Table 8-4 Key functions - operator view

Key	Function
	No functionality
	Go to the previous operator view
	Go to the next operator view
	Enter the menu structure access point

#### Single value

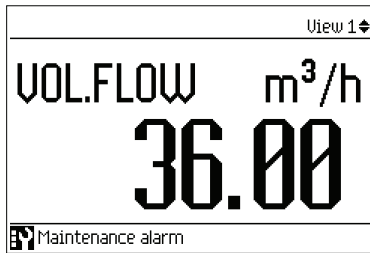

FS0033SS.01.02

#### Three values

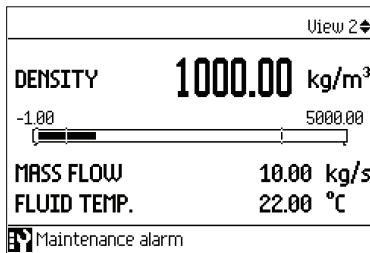

FS0034SS.01.02

### 1 value and bargraph

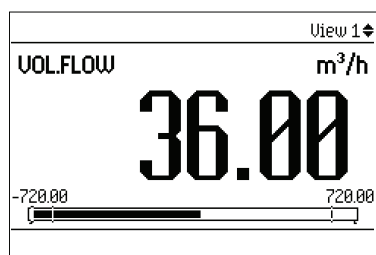

FS0035SS.01.02

#### Note

#### Bargraphs

The bargraph limit values indicate the set lower and upper alarm limits, and the vertical lines in the bargraph indicate the set lower and upper warning limits.

### 1 value and graph

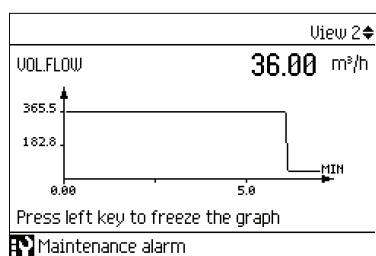

### Six values

View 4		
MASS FLOW	36000.00	kg/h
DENSITY	1000.00	kg/m <sup>3</sup>
FLUID TEMP.	22.00	°C
VOL.FLOW	36.00	m <sup>3</sup> /h
PRESSURE	3.00	Pa
TOT1	727587.38	kg
Maintenance alarm		

8.1 Operating the device on the local display

8.1.4 Operating the totalizer

When totalizer is displayed in the main view, press  to access the totalizer operation.

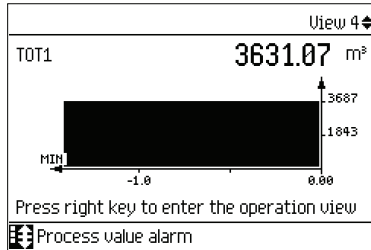



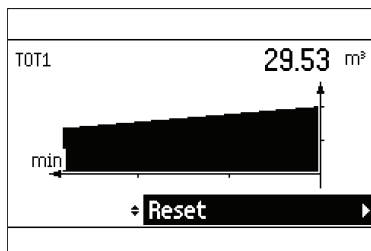



Table 8-5 Key functions - totalizer operation

Key	Function
	Exit totalizer operation
	Select action to perform
	Select action to perform
	Perform selected action



8.1.5 Handling alarms

When the alarm list is displayed in the main view, press  to get more detailed information about the active alarms.

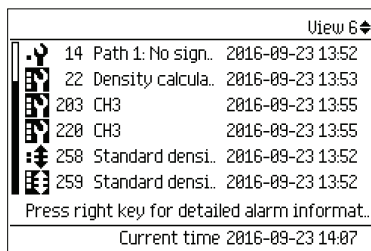
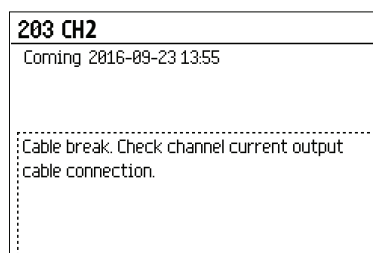
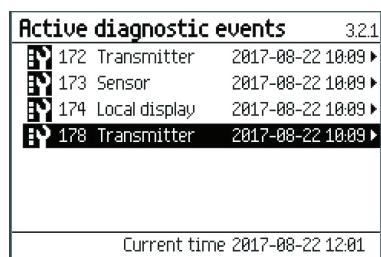



Table 8-6 Key functions - alarms list view

Key	Function
	Exit alarm list view
	Select the item above in the list; keep pressing the key to accelerate scrolling up the selection list
	Select the item below in the list; keep pressing the key to accelerate scrolling down the selection list
	View more information on the selected alarm



Press to exit the detailed alarm information.

## Alarm acknowledgement

There are two ways to have the alarms removed from the alarm list.

- Manual: The alarm remains in the alarm list until the alarm is manually acknowledged (ack.). Before the alarm can be acknowledged, the cause must be eliminated. Press to go to the detailed alarm information. Press again to acknowledge the alarm. The time of the acknowledgement is shown in the history log.

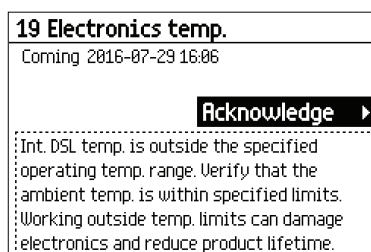

- Auto: The alarm is removed from the alarm list when the cause is removed (going)

### 8.1.6 Reading the diagnostic values

One of the main views can be configured to show six diagnostic values.

		View 5
UOL.FLOW	3.60	m <sup>3</sup> /h
FLOW UEL	1299.21	in/s
SOUND UEL	32.00	m/s
MASS FLOW	3600.00	kg/h
DENSITY	1000.00	kg/m <sup>3</sup>
TOT1	137393.95	kg
Maintenance alarm		

## 8.2 Reading / changing parameters

### 8.2.1 Parameter view

The parameter view presents the menu structure of the device. All menu items are uniquely identified with a menu item number.

Level 1 of the parameter view (entered from the operation view) is standardized for all Siemens Process Instrumentation devices and covers the following groups:

- Quick start (menu): Lists the most important parameters for quick configuration of the device. All parameters in this view can be found elsewhere in the menu.
- Setup (menu): Contains all parameters which are needed to configure the device.
- Maintenance and diagnostics (menu): Contains parameters which affect the product behavior regarding maintenance, diagnostics and service.  
Examples: Verification, failure prediction, device health, data logging, alarm logging, report, condition, monitoring, tests, etc.

- Security (menu): Contains parameters which describe all security settings of the device.
- Language (parameter): Parameter for changing the language of the local display. Regardless of the language setting, the term for this parameter is always the English term (Language).

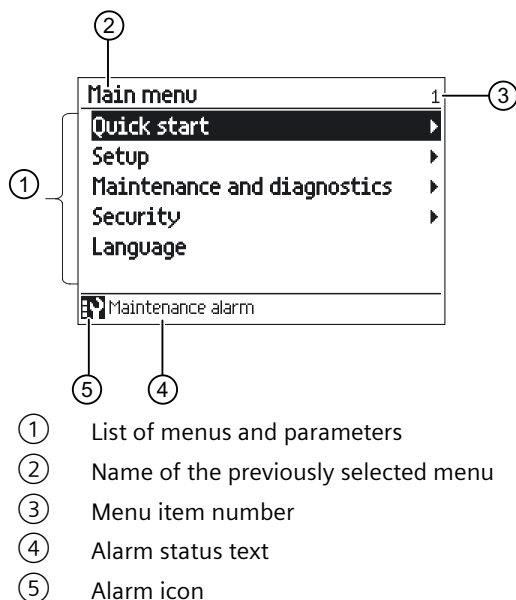

Figure 8-1 Example of parameter view

- ① List of menus and parameters
- ② Name of the previously selected menu
- ③ Menu item number
- ④ Alarm status text
- ⑤ Alarm icon

### Locked parameters

A lock icon (🔒) in the parameter view indicates that the parameter is read only.

For further information on how to gain access to the menus, see Access control (Page 40).

## 8.2.2 Alphanumeric parameters

### Read only

The view shows the set value. Press to exit the view.

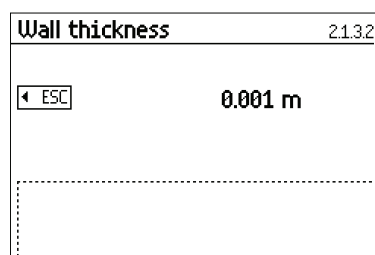

### Edit

Editable alphanumeric parameters are displayed as shown here.

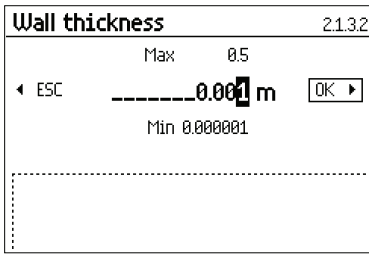

Table 8-7 Key functions - editing alphanumeric values

Key	Function
◀	Select the next left position. If the most left position is selected: exit the parameter edit view without confirming the changes. Keep pressing the key to jump to the most left position.
▲	Change the selected number/character. Numeric characters: increase the number by one (for example from 7 to 8) ASCII characters: select the previous character in the alphabet.
▼	Change the selected number/character. Numeric characters: decrease the number by one (for example. from 8 to 7) ASCII characters: select the next character in the alphabet.
▶	Select the next right position. If most right position is selected: confirm the change and exit the parameter edit view. Keep pressing the key to jump to the most right position.

**Note**

Ensure that the new value is within the minimum/maximum range when changing numeric values.

**Note**

**##### signs in display**

The display is unable to show the measured value or the value is missing or invalid. Try to fix by changing the measurement units or the resolution.

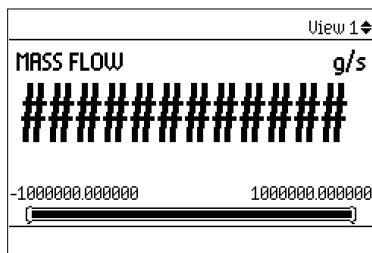

**Changing the resolution**



In order to change the resolution of the process value shown in the operation view (for example mass flow), set the decimal places parameter for the selected process value. For example, the decimal places for process value Mass flow is defined in **Decimal places**.

The resolution can also be changed by changing the resolution of one configuration parameter for this process value. For example **Low flow cut-off**. Any changes in resolution will change the resolution of all configuration parameters for this process value as well.

### 8.2.3 Parameter lists

#### Parameter list - read only

Table 8-8 Key functions - read only



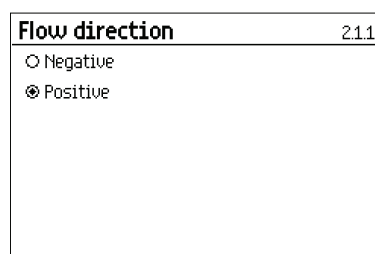

Key	Function
	Exit parameter list
	No functionality
	No functionality
	No functionality



#### Parameter list - editable

The help texts describe the possible adjustments of the respective parameters.



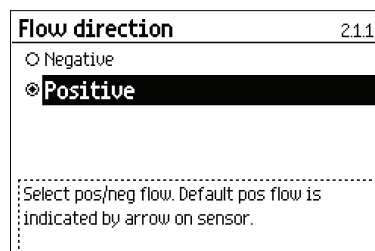

Table 8-9 Key functions - edit

Key	Function
	Escape the view without changing the value.
	Select the option above.
	Select the option below.
	Confirm selected option.



### Multiselection

Table 8-10 Key functions - multiselection of options

Key	Function
	Escape the view without changing the value.
	Scroll up in the list. If the uppermost position is selected: highlight Save settings.
	Scroll down in the list. If the lowermost position is selected: highlight Save settings.
	Select / deselect option.

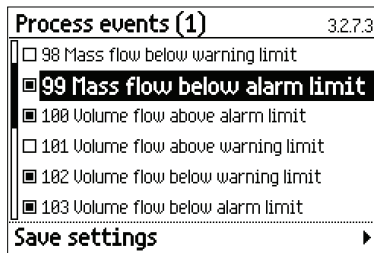

It is possible to select/deselect multiple alarms to be suppressed. The marked alarms will **NOT** be suppressed.

## Parameter assignment

### 9.1 Multipoint calibration

The transmitter provides an additional 20 point piecewise linear calibration table with user selectable input value: volume flow, reynolds number or fluid sound velocity. The table can be configured for either unidirectional or bidirectional calibration.

---

**Note****Ascending order by reynolds number**

The datapoints must be entered in ascending order by reynolds number.

---

9.1 Multipoint calibration

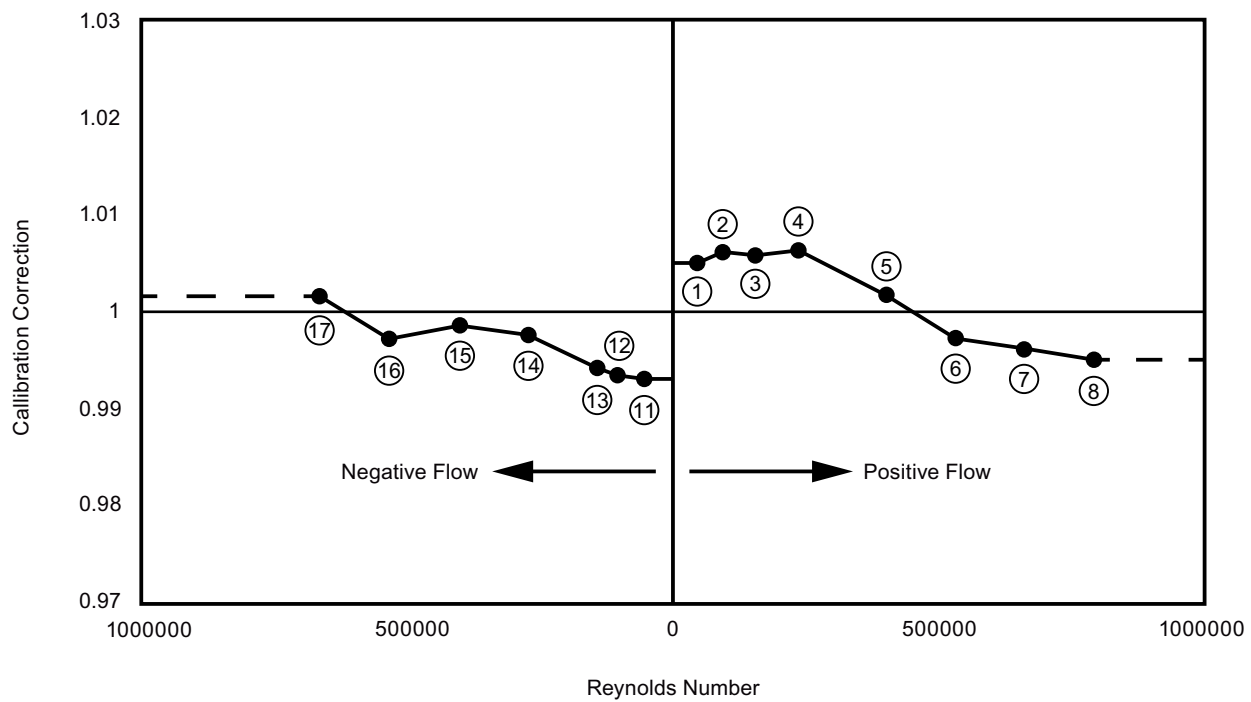

Point	Reynolds number	Calibration correction	Point	Reynolds number	Calibration correction
①	47339	1.0050	⑪	54231	0.9930
②	94701	1.0060	⑫	102932	0.9934
③	156034	1.0058	⑬	141382	0.9942
④	238385	1.0062	⑭	271843	0.9975
⑤	402304	1.0017	⑮	402304	0.9984
⑥	532765	0.9971	⑯	532765	0.9971
⑦	663226	0.9960	⑰	663226	1.0015
⑧	793687	0.9950	⑱	0	0
⑨	0	0	⑲	0	0
⑩	0	0	⑳	0	0

Figure 9-1 User calibration table behavior (bidirectional calibration)



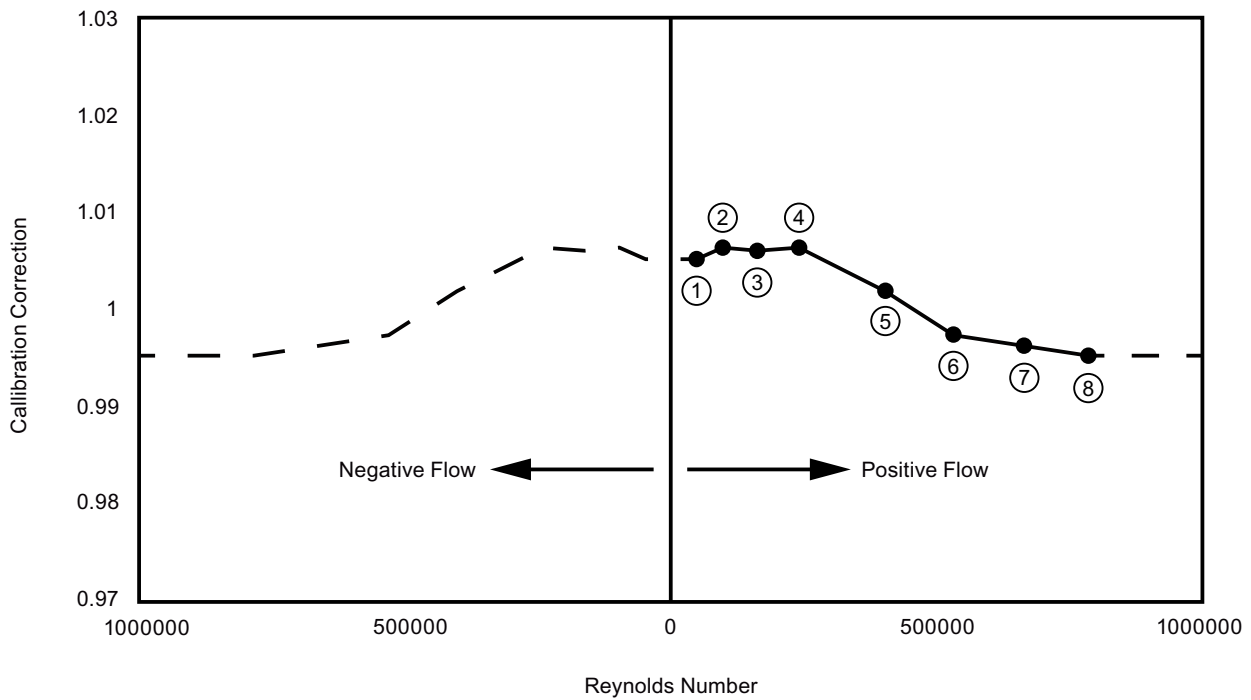

Point	Reynolds number	Calibration correction
①	47339	1.0050
②	94701	1.0060
③	156034	1.0058
④	238385	1.0062
⑤	402304	1.0017
⑥	532765	0.9971
⑦	663226	0.9960
⑧	793687	0.9950
⑨	0	0
⑩	0	0

Figure 9-2 User calibration table behavior (unidirectional calibration)

## 9.2 Inputs and outputs

The available configuration of the hardware functionality of input and output is described in the following table.

Table 9-1 Hardware and software configuration of the input/output channels

Channel	HW configuration (fixed when ordering)	SW configuration available to the user
1	Modbus	Modbus
2	Current output	Current output (0/4-20 mA)

Channel	HW configuration (fixed when ordering)	SW configuration available to the user
3	Relay output	Status Output: <ul style="list-style-type: none"> <li>• Status signals</li> <li>• Alarm and diagnostics</li> <li>• Flow direction</li> </ul>
4	Output	<ul style="list-style-type: none"> <li>• Frequency output</li> <li>• Pulse output</li> </ul>
7	Digital input	Reset totalizer 1
8	Digital input	Pause/resume totalizer 1

## Current output

### Current output configuration

The following process values can be assigned to the current output:

- Volume flow
- Mass flow
- Flow velocity
- Sound velocity
- Density
- Kinematic viscosity
- Medium temperature

The accuracy specified for the analog output signal applies only within the range 4 to 20 mA. Lower limit (4 mA) and upper limit (20 mA) can be assigned to any specific measurement values.

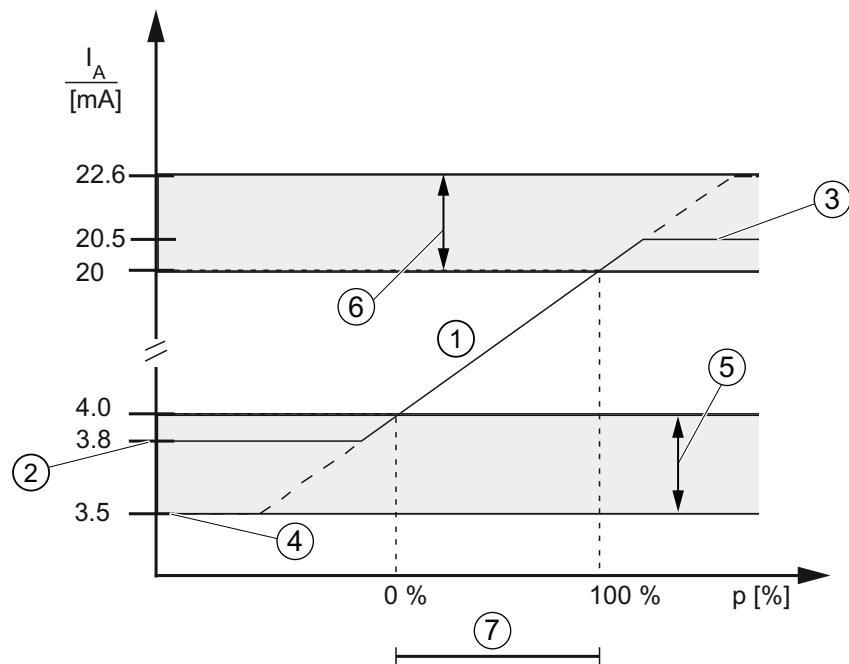

- ① Linear control range
- ② Lower saturation limit
- ③ Upper saturation limit
- ④ Lower fault current value
- ⑤ Recommended setting range for lower fault current
- ⑥ Recommended setting range for upper fault current
- ⑦ Measuring range

Figure 9-3 Current limits for NAMUR configuration

The fail safe current output signal can be selected to:

- Lower fault current (defined in the Loop current scale selection)
- Upper fault current (defined in the Loop current scale selection)
- Last valid value (the last process value before the failure occurred)
- Current value (actual measured value)
- Fail-safe value (within the range of 0 mA to 25 mA <sup>1)</sup>)

#### Output scaling configuration

Below are four examples describing configuration possibilities for a current output.

**Positive flow with negative scaling**

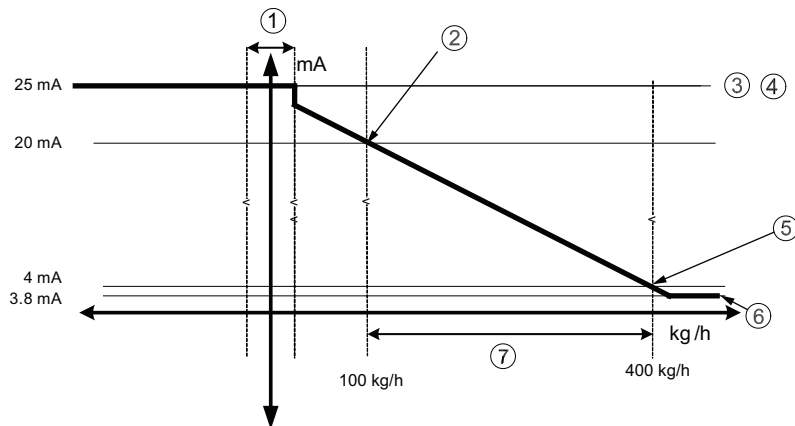

- ① Low flow cut-off
- ② Upper range value
- ③ Maximum output current
- ④ Upper fault current
- ⑤ Lower range value
- ⑥ Lower saturation limit
- ⑦ Span

*Current output setting*

- Process value = Mass flow
- Direction = Positive
- Loop current scale = 4-20 mA (maximum 25 mA)
- Upper range value = 100 kg/h
- Lower range value = 400 kg/h
- Fail-safe behaviour = Upper fault current
- Low flow cut-off = 25 kg/h

### Positive flow across zero with positive scaling

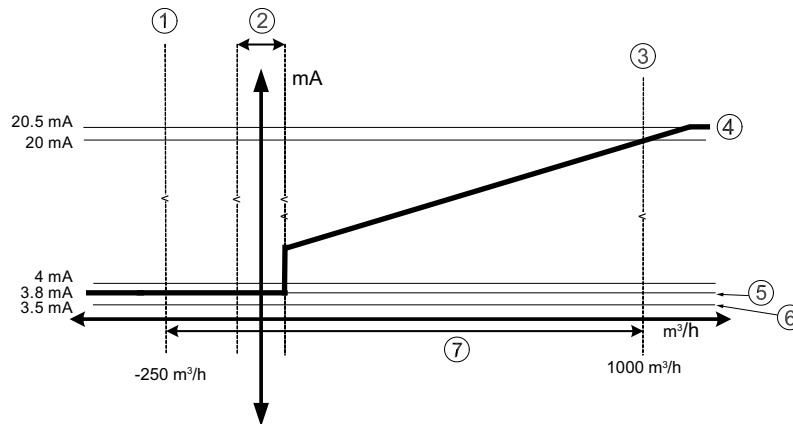

- ① Lower range value
- ② Low flow cut-off
- ③ Upper range value
- ④ Upper saturation limit
- ⑤ Lower saturation limit
- ⑥ Lower fault current
- ⑦ Measuring range

#### Current output setting

- Process value = Mass flow
- Direction = Bidirectional
- Loop current scale = 4-20 mA NAMUR
- Upper range value = 1000 m<sup>3</sup>/h
- Lower range value = -250 m<sup>3</sup>/h
- Fail-safe behaviour = Upper fault current
- Low flow cut-off = 25 m<sup>3</sup>/h

**Bidirectional flow across zero with positive scaling**

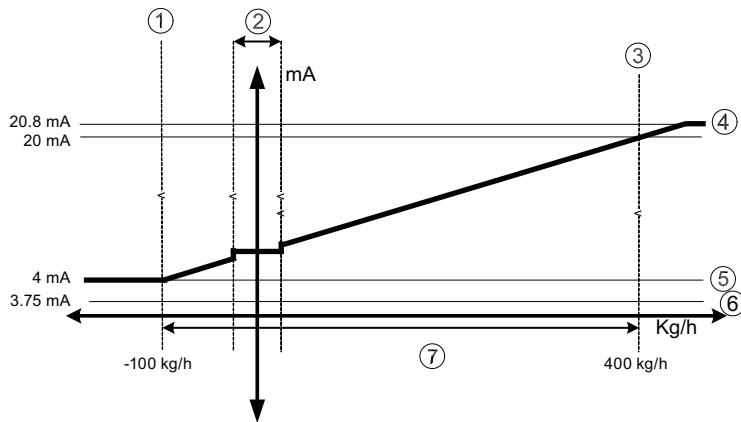

- ① Lower range value
- ② Low flow cut-off
- ③ Upper range value
- ④ Upper saturation limit
- ⑤ Lower saturation limit
- ⑥ Lower fault current
- ⑦ Span

*Current output setting*

- Process value = Mass flow
- Direction = Bidirectional
- Loop current scale = 4-20 mA US
- Upper range value = 400 kg/h
- Lower range value = -100 kg/h
- Fail-safe behaviour = Minimum current
- Low flow cut-off = 25 kg/h

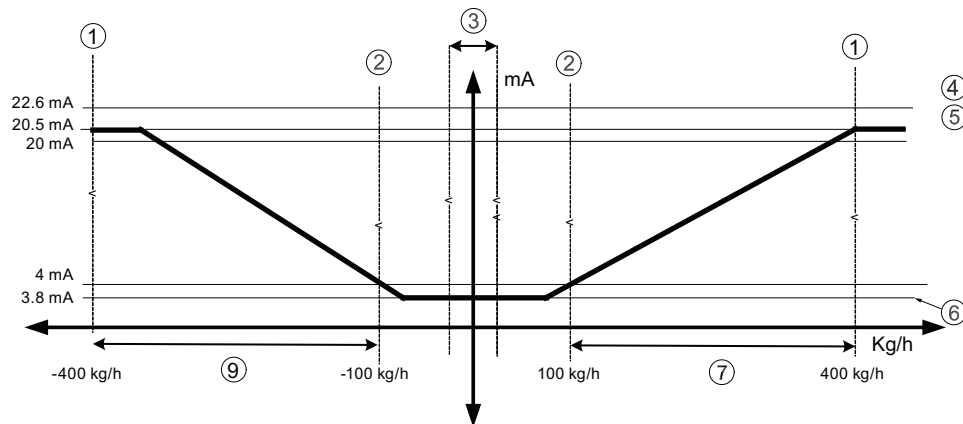
**Bidirectional flow with symmetrical scaling**

- ① Upper range value
- ② Lower range value
- ③ Low flow cut-off
- ④ Upper fault current
- ⑤ Upper saturation limit
- ⑥ Lower saturation limit
- ⑦ Span

**Current output setting**

- Process value = Mass flow
- Direction = Bidirectional (Symmetric)
- Loop current scale = 4-20 mA NAMUR
- Upper range value = 400 kg/h
- Lower range value = 100 kg/h
- Fail-safe behaviour = Upper fault current
- Low flow cut-off = 25 kg/h

**Pulse output**

The pulse output function supplies pulses equivalent to a configured amount of accumulated volume or mass. The pulse width is configured and the pulse repetition is proportional to the selected flow rate.

**Pulse repetition**

Pulse repetition is calculated as follows:

$$\text{Pulse repetition} = \frac{\text{Amount per pulse}}{\text{Measured flow rate}}$$

FC0026.01

**Example**

- Pulse output configuration (channels 2 to 4)
  - Operation mode = Pulse output
  - Process value = Mass flow
  - Amount per pulse = 1 kg
  - Pulse width = 1 ms
- Measured mass flow value = 10 kg/s (constant)

Result:

- Pulse repetition = 100 ms
- Output frequency = 10 pulses per second with a pulse width of 1 ms
- Remaining time between pulses is 99 ms

$$\text{Pulse repetition} = \frac{\text{Amount per pulse}}{\text{Measured flow rate}}$$

FC0026.01

**Note**

Pulse width must be selected with the view that remaining time is always greater than pulse width at the highest measured flow.

**Frequency output**

The frequency output function supplies a frequency (50% duty cycle) proportional to the selected process value.

Frequency is calculated as follows:

$$\text{Frequency} = \frac{\text{Measured mass flow value}}{\text{Upper range value} - \text{Lower range value}} \times (\text{Frequency value high} - \text{Frequency value low})$$

**Example**

This example shows how to calculate the output frequency for any measured flowrate:

Frequency output configuration:

- Operation mode = Frequency output (Channel 2 to 4)
- Process value = Mass flow
- Direction = Positive
- Frequency value high = 12 kHz
- Frequency value low = 2 kHz
- Upper range value = 15 kg/s
- Lower range value = 5 kg/s



Measured mass flow value = 7.5 kg/s (constant)

*Result:*

- Frequency = 4.5 kHz

---

**Note**

The connected equipment must be capable of registering the full range of frequencies configured.

---

## Status output

The status output can be used to show alarm status and it can be signaled on Status output or Relay output.

---

**Note****Flow direction warning**

The limit function for the current output can be used to signal the flow direction by setting the Lower warning limit for the Process value to 0. A warning will occur in case of negative flow.

This warning can be output on the status output if Status mode is set to Alarm item and the Process alarms (1) [relevant process value] below warning limit is selected.

---

Depending on the Status mode setting, multiple alarms can be signaled on the output and selected from the alarm class or the alarm item lists.

- Alarm class: Alarm will be signaled if alarm within the selected alarm class occurs.
- Alarm item: Alarm will be signaled if selected alarm item occurs. It is possible to select multiple alarms to be signaled.

---

**Note****Alarm class / NAMUR status signals**

The options depend on the setting selected in **Staus icons**, either NAMUR status signals or Alarm class (Siemens Standard).

---

## 9.2.1 Digital input

### Digital input

If the input signal is activated with a logical signal (15 to 30 V DC) and the Polarity is set to Active high level, the meter carries out an activity selected in the menu Input function:

- Reset totalizer 1 on channel 7
- Pause/resume totalizer 1 on channel 8

---

**Note**

**Changing polarity**

Changing the polarity triggers the signal input to executes the parameterized function.

---

## Service and maintenance

### 10.1 Basic safety notes

---

#### Note

The device is maintenance-free.

---

#### 10.1.1 Maintenance

The device is maintenance-free. However, a periodic inspection according to pertinent directives and regulations must be carried out.

An inspection can include, for example, check of:

- Ambient conditions
- Seal integrity of the process connections, cable entries, and cover
- Reliability of power supply, lightning protection, and grounds

 <b>WARNING</b>
--

<b>Dust layers above 5 mm</b>
-------------------------------

Risk of explosion in hazardous areas.
---------------------------------------

Device may overheat due to dust build up.
---

- |   |
|---|
| <ul style="list-style-type: none"> <li>• Remove dust layers in excess of 5 mm.</li> </ul> |
|---|

 <b>WARNING</b>
--

<b>Use of a computer in a hazardous area</b>
--

If the interface to the computer is used in the hazardous area, there is a risk of explosion.
---

- |   |
|---|
| <ul style="list-style-type: none"> <li>• Ensure that the atmosphere is explosion-free (hot work permit).</li> </ul> |
|---|

<b>NOTICE</b>
---------------

<b>Penetration of moisture into the device</b>
--

Damage to device.
-------------------

- |   |
|---|
| <ul style="list-style-type: none"> <li>• Make sure when carrying out cleaning and maintenance work that no moisture penetrates the inside of the device.</li> </ul> |
|---|

## 10.2 Cleaning

### Cleaning the enclosure

- Clean the outside of the enclosure with the inscriptions and the display window using a cloth moistened with water or a mild detergent.
- Do not use any aggressive cleansing agents or solvents, e.g. acetone. Plastic parts or the painted surface could be damaged. The inscriptions could become unreadable.

 <b>WARNING</b>
<b>Electrostatic charge</b> Risk of explosion in hazardous areas if electrostatic charges develop, for example, when cleaning plastic surfaces with a dry cloth. <ul style="list-style-type: none"><li>• Prevent electrostatic charging in hazardous areas.</li></ul>

<b>NOTICE</b>
<b>Improper cleaning of diaphragm</b> Damage to device. The diaphragm can be damaged. <ul style="list-style-type: none"><li>• Do not use sharp or hard objects to clean the diaphragm.</li></ul>

## 10.3 Maintenance and repair work

 <b>WARNING</b>
<b>Impermissible repair of the device</b> <ul style="list-style-type: none"><li>• Repair must be carried out by Siemens authorized personnel only.</li></ul>

 <b>WARNING</b>
<b>Impermissible repair and maintenance of the device</b> <ul style="list-style-type: none"><li>• Repair and maintenance must be carried out by Siemens authorized personnel only.</li></ul>

 <b>WARNING</b>
<b>Impermissible repair of explosion protected devices</b> Risk of explosion in hazardous areas <ul style="list-style-type: none"><li>• Repair must be carried out by Siemens authorized personnel only.</li></ul>

 **WARNING****Maintenance during continued operation in a hazardous area**

There is a risk of explosion when carrying out repairs and maintenance on the device in a hazardous area.

- Isolate the device from power.
- or -
- Ensure that the atmosphere is explosion-free (hot work permit).

 **WARNING****Impermissible accessories and spare parts**

Risk of explosion in areas subject to explosion hazard.

- Only use original accessories or original spare parts.
- Observe all relevant installation and safety instructions described in the instructions for the device or enclosed with the accessory or spare part.

 **WARNING****Humid environment**

Risk of electric shock.

- Avoid working on the device when it is energized.
- If working on an energized device is necessary, ensure that the environment is dry.
- Make sure when carrying out cleaning and maintenance work that no moisture penetrates the inside of the device.

 **WARNING****Enclosure open**

Risk of explosion in hazardous areas as a result of hot components and/or charged capacitors inside the device.

To open the device in a hazardous area:

1. Isolate the device from power.
2. Observe the wait time specified in Technical specifications (Page 79) or on the warning sign before opening the device.
3. Visually inspect sensor inlet and outlet.

**Exception:** Devices exclusively having Intrinsic safety (Ex i) may be opened in an energized state in hazardous areas.

**⚠ WARNING**

**Improper connection after maintenance**

Risk of explosion in areas subject to explosion hazard.

- Connect the device correctly after maintenance.
- Close the device after maintenance work.

Refer to Connecting (Page 25).

**⚠ CAUTION**

**Hazardous voltage at open device**

Risk of electric shock when the enclosure is opened or enclosure parts are removed.

- Before you open the enclosure or remove enclosure parts, de-energize the device.
- If maintenance measures in an energized state are necessary, observe the particular precautionary measures. Have maintenance work carried out by qualified personnel.

### 10.3.1 Removing or replacing the battery

#### Removing or replacing the battery

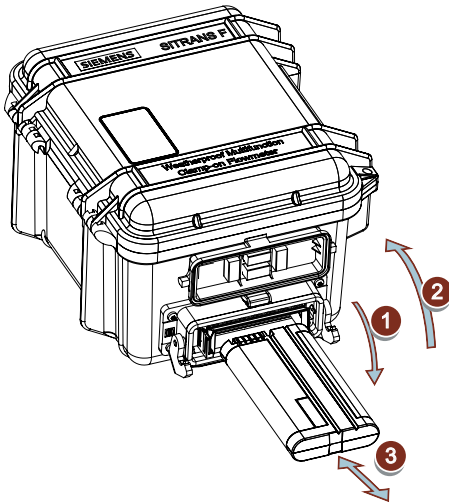

**Note****Hot swapping the battery**

After removing the battery FST090 stays on for around 30 s. With a second battery you can hot swap the battery without connecting the Auxiliary Power Adapter. A second battery can be ordered with order number: A5E50084513 under PIA Life Cycle Portal (<https://www.pia-portal.automation.siemens.com>).

1. Push down the latch on the lid.
2. Open up the lid.
3. Slide out the battery.
4. Replace the battery in reverse order.

### 10.3.2 Removing or replacing the SensorFlash microSD card

**Before you remove the SensorFlash microSD card**

- Make sure to eject the SensorFlash microSD card through menu 3.7.1 or by turning data logging off (menu 3.7.5.1).

**Removing or replacing the SensorFlash microSD card**

Figure 10-1 SensorFlash microSD card removal

**NOTICE****Potential loss of data!**

Eject the SensorFlash microSD card before removing it. Otherwise your last data point will be corrupted.

---

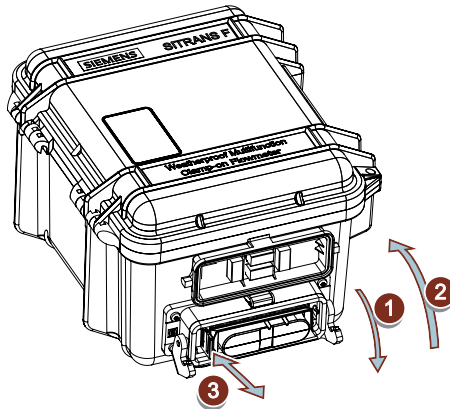
**Note**

**SensorFlash functions support**

Only the supplied 4 GB SD cards are supported for backup, restore, logging, and firmware update.

---

1. Push down the latch on the lid.
2. Open up the lid.
3. To the left of the battery push down on the SensorFlash microSD card and pull it out.
4. Insert the SensorFlash microSD card in reverse order.

## 10.4 Transport

### 10.4.1 Transport with fitted battery

<b>NOTICE</b>
<b>Transport with fitted battery</b> If subject to shock or vibration during transportation or when returning the device, do one of the following: <ul style="list-style-type: none"><li>• Remove the battery and package securely, include it separately in the return consignment.</li><li>• Dispose of the battery according to regulations.</li></ul>



 <b>WARNING</b>
<b>Pinch point</b> Lock the lid of the transmitter before moving or transporting the device. Risk of crushing, if lid is left open or unlocked.

## 10.5 Return procedure

To return a product to Siemens, see Returns to Siemens ([www.siemens.com/returns-to-siemens](http://www.siemens.com/returns-to-siemens)).



Contact your Siemens representative to clarify if a product is repairable, and how to return it. They can also help with quick repair processing, a repair cost estimate, or a repair report/cause of failure report.

#### NOTICE

##### Decontamination

The product may have to be decontaminated before it is returned. Your Siemens contact person will let you know for which products this is required.

## See also

Decontamination declaration (<https://www.siemens.com/sc/declarationofdecontamination>)

Return goods delivery note (<https://www.siemens.com/processinstrumentation/returngoodsnote>)

#### Note

##### Return of products with lithium batteries

Lithium batteries are dangerous goods according to the Regulation of Dangerous Goods, UN 3090 and UN 3091.

- Remove lithium batteries prior to shipment.
- If the battery cannot be removed, return the product according to the Regulation of Dangerous Goods with special transport documentation.

## 10.6 Disposal



Devices described in this manual should be recycled. They may not be disposed of in the municipal waste disposal services according to the Directive 2012/19/EC on waste electronic and electrical equipment (WEEE).

Devices can be returned to the supplier within the EC and UK, or to a locally approved disposal service for eco-friendly recycling. Observe the specific regulations valid in your country.

Further information about devices containing batteries can be found at: Information about battery / product return (WEEE) (<https://support.industry.siemens.com/cs/document/109479891/>)

#### Note

##### Special disposal required

The device includes components that require special disposal.

- Dispose of the device properly and environmentally through a local waste disposal contractor.



## Diagnostics and troubleshooting

### 11.1 Device status symbols

Device status is shown using symbols and text on the local display. Additionally, the symbol and respective text message for each device status can be seen in remote engineering, asset management or process control systems.

Messages are shown on the display.

- In the operation view, alarms are shown as a combination of symbol and text in the lower line of the display. If several diagnostic messages are active at the same time, the most critical is shown.
- In the alarm list view all active alarms are shown as a list. The alarm list combines a symbol, text and an alarm ID number. The alarms are arranged according to the alarm ID numbers. The alarm list view can also be accessed via parameter "Active diagnostic events".
- In the alarm history view the most recent alarms (up to 100) are listed. The alarm history log can be viewed in parameter "Diagnostic log". The alarm history log can be reset in parameter "Reset log".

#### Device status characteristics

The following table provides possible cause of device status, and actions for the user or service.





The device provides two types of alarm formats; symbols used on the local display are based on NAMUR status signals or Siemens standard alarm classes, selected in parameter "Status icons".

In SIMATIC PDM, symbols are based on Siemens standard alarm classes.





























### 11.2 Device status symbols (chart)











The sequence of symbols in the table corresponds to the priority of the device status, beginning with the most critical.

#### Device status symbols

Local display - Siemens standard			SIMATIC PDM/PLC				
Symbol	Device status	Priority **	Symbol			Device status	Priority **
	Maintenance alarm	1				Maintenance alarm	1
<p><b>Cause:</b> Output signal invalid due to fault in the field device or in the peripherals.</p> <p><b>Action:</b> Maintenance is required immediately.</p>							

11.2 Device status symbols (chart)

Local display - Siemens standard			SIMATIC PDM/PLC				
Symbol	Device status	Priority **	Symbol			Device status	Priority **
	Maintenance demanded	2				Maintenance demanded	2
<p><b>Cause:</b> Output signal is still valid, but wear reserve is almost exhausted and/or a function will be limited soon.  <b>Action:</b> Maintenance is strongly recommended as soon as possible.</p>							
	Maintenance required	3				Maintenance required	3
<p><b>Cause:</b> Output signal is still valid. No functional restriction detected but end of wear reserve expected in next weeks.  <b>Action:</b> Maintenance of device should be planned.</p>							
	Manual operation	4				Manual operation	4
<p><b>Cause:</b> Output signal temporarily invalid (e.g. frozen) due to work being performed on the device.  <b>Action:</b> Disable manual mode via HMI or engineering system.</p>							
	Simulation or substitute value	5				Simulation or substitute value	5
<p><b>Cause:</b> Output signal temporarily does not represent the process because output based on a simulation value.  <b>Action:</b> Disable simulation mode via HMI or engineering system or restart device.</p>							
	Out of service	6				Out of service	6
<p><b>Cause:</b> Output signal does not represent process value. Device mode is set to "Out of service".  <b>Action:</b> Disable "Out of service" and enable normal operation.</p>							
	Configuration error	7			 (red)	Configuration error	7
<p><b>Cause:</b> Output signal invalid due to parameter setting, connection error or configuration error in the HW.  <b>Action:</b> Check hardware configuration or parameter settings of the device via HMI or engineering system.</p>							
	Process value alarm	8				Process value alarm	8
<p><b>Cause:</b> Deviations from permissible ambient or process conditions detected by the device (through self-monitoring, or warnings / faults in the device) indicate that the measured value is unreliable or deviations from the set value in the actuators is most likely greater than anticipated under normal operating conditions. Process or ambient conditions will damage the device or result in unreliable output.  <b>Action:</b> Check ambient temperature or process conditions. If possible, install device at different location.</p>							

Local display - Siemens standard			SIMATIC PDM/PLC				
Symbol	Device status	Priority **	Symbol		Device status	Priority **	
	Configuration warning	9				Configuration warning	9
<p><b>Cause:</b> &lt;&lt;for SIL device&gt;&gt;Safety validation is not completed.  <b>Action:</b> &lt;&lt;for SIL device&gt;&gt;Complete the functional test and confirm that the functional test has passed in the wizard Functional Safety.  <b>Cause:</b> &lt;&lt;for non-SIL device&gt;&gt;Device can operate, but one or more parameters are incorrectly configured.  <b>Action:</b> &lt;&lt;NO action for non-SIL device&gt;&gt;</p>							
	Process value warning	10				Process value warning	10
<p><b>Cause:</b> Deviations from permissible ambient or process conditions detected by the device (through self-monitoring, or warnings / faults in the device) indicate that the measured value is unreliable or deviations from the set value in the actuators is most likely greater than anticipated under normal operating conditions. Process or ambient conditions can damage the device or result in unreliable output.  <b>Action:</b> Check ambient temperature or process conditions. If possible, install device at different location.</p>							
	Process value tolerance	11				Process value tolerance	11
<p><b>Cause:</b> At least one process value has exceeded or fallen below a process tolerance limit parameter set in device.  <b>Action:</b> Check that limit parameter settings are suitable for application.</p>							
no symbol shown	Configuration changed	12			no symbol shown	Configuration changed	12
<p><b>Cause:</b> The device configuration has changed due to a work process.  <b>Action:</b> Reset configuration flag to clear diagnostic message.</p>							
no symbol shown	no assignment	13			no symbol shown	no assignment	13
<p><b>Cause:</b> Device status ok. No active diagnostic errors.  <b>Action:</b> No action required.</p>							

\* Lowest priority number equals highest fault severity.

\*\* Both the Siemens standard symbol and its corresponding Namur symbol (from device display) will be shown in SIMATIC PDM.



## Technical specifications

### Note

#### Device specifications

Siemens makes every attempt to ensure the accuracy of these specifications but reserves the right to change them at any time.

## 12.1 Power

Table 12-1 Power supply

Description	Specification
Supply voltage <sup>1)</sup> (double insulation or reinforced insulation)	<ul style="list-style-type: none"> <li>Lithium-ion battery 14.4 V DC</li> <li>External adaptor 100 - 240 V AC (Output voltage range: 20-28 V DC)</li> </ul>
Power consumption	DC = 10 W
Reverse polarity protection (y / n)	Y
Galvanic isolation	3000 V AC

<sup>1)</sup> Only use FST090 power adapter (7ME3940-3P...-....) as external power source

## 12.2 Inputs

Table 12-2 Digital input

Description	Channel 7
Load	15 to 30 V DC, $R_{in}$ 7 kOhm
Functionality	<ul style="list-style-type: none"> <li>Reset totalizer</li> </ul>

Table 12-3 Digital input

Description	Channel 8
Load	15 to 30 V DC, $R_{in}$ 7 kOhm
Functionality	<ul style="list-style-type: none"> <li>Start/Stop totalizer</li> </ul>

12.3 Outputs

## 12.3 Outputs

Table 12-4 Current output

Description	Channel 2					
Signal range	0/4 to 20/24 mA					
Resolution	0.4 $\mu$ A					
Load	<770 $\Omega$					
Time constant (adjustable)	0.0 to 100 s					
Fault current	4...20 NA-MUR	4...20 US	4...20	4...24 mA	0...20 mA	0...20 mA
Measurement range (mA)	3.8 - 20.5	4.0 - 20.8	4.0 - 20.5	4.0 - 24.0	0.0 - 20.5	0.0 - 24.0
Lower fault current (mA)	3.5	3.75	2.0	2.0	0.0	0.0
Upper fault current (mA)	22.6	22.6	22.0	25.0	22.0	25.0
Customized fail-safe mode	<ul style="list-style-type: none"> <li>• Last valid value                             <ul style="list-style-type: none"> <li>– Lower fault current</li> <li>– Upper fault current</li> </ul> </li> <li>• Fail-safe value</li> <li>• Current value</li> </ul>					
Galvanic isolation	Galvanically isolated PELV circuit with 60 V DC isolation from each other and ground. Maximum test voltage: 500 V AC					
Cable	Standard industrial signal cable with up to 3 twisted pairs with overall screen can be connected between the transmitter and the control system. Individual pair or overall screen is optional depending on user requirements.					
Voltage range	14 to 30 V DC (passive)					

Table 12-5 Relay output

Description	Channel 3
Type	Change-over voltage-free relay contact
Load	30 V DC (30 V AC peak), 100 mA
Functions	<ul style="list-style-type: none"> <li>• Alarm class / NAMUR status</li> <li>• Alarm item</li> </ul>

Table 12-6 Input/output

Description	Channel 4
Pulse	41.6 $\mu$ s to 5 s pulse duration
Resolution	1 $\mu$ s
Frequency	0 to 10 kHz, 50 % duty cycle, 120 % overscale provision
Resolution	0.2 Hz
Load	< 750 $\Omega$
Time constant (adjustable)	0 to 100 s
Active	0 to 24 V DC, 87 mA, short-circuit-protected



Description	Channel 4
Passive	3 to 30 V DC, 100 mA, short-circuit-protected
Functions	<ul style="list-style-type: none"> <li>• Pulse</li> <li>• Frequency</li> <li>• Alarm class / NAMUR status</li> <li>• Alarm item</li> </ul>

## 12.4 Construction

Table 12-7 Designated use

Description	Specification
Measurement of process medium	<ul style="list-style-type: none"> <li>• Fluid Group 1 (suitable for dangerous fluids)</li> <li>• Aggregate state: Past/light slurry, liquid and gas</li> </ul>

Table 12-8 System design

Description	Specification
Measuring principle	Ultrasonic
System architecture	Self contained ultrasonic flowmeter, with internal battery, and all functions on multiple pc boards, enclosed in a ruggedized IP67 portable housing with quick connect BNC receptacles for temporary installations.

### Device design

Table 12-9 Wall mount housing transmitter design

Description	Specification
Dimensions	See Dimension drawings (Page 85)
Weight	4.0 kg (8.82 lb)
Design	Portable IP67 case with handle
Material	Polypropylene
Ingress protection	<ul style="list-style-type: none"> <li>• IP67 with lid closed.</li> <li>• IP65 with lid open.</li> </ul>
Mechanical load	10-200 Hz @ 1 m <sup>2</sup> /s <sup>2</sup> 200-2000 Hz @ 0.3 m <sup>2</sup> /s <sup>2</sup>

Table 12-10 Installation torques

Description	Torque (Nm)
Cable gland to enclosure (Siemens supplied, metric)	10

## 12.5 Operating conditions

Table 12-11 Basic conditions

Description		Specification
Ambient temperature (Humidity max. 90 %)	Battery operated: Power supply operated:	-10 °C to +50 °C (14 °F to +122 °F) -10 °C to +40 °C (14 °F to +104 °F)
Ambient temperature (Humidity max. 90 %)	Storage:	-20 °C to +60 °C (-4 °F to +140 °F) <sup>1)</sup>
Climate class		DIN 60721-3-4
Altitude		Up to 2000 m (6560 ft)
Pollution		Degree 3
Relative humidity		95 %
Bump resistance		IEC 60721-3-7 Class 7M2
Shock resistance		IEC 60721-3-7 Class 7M2
Thermal shock		IEC 60721-3-7 Class 7M2
Vibration resistance		IEC 60721-3-7 Class 7M2
EMC performance	<ul style="list-style-type: none"> <li>Emission</li> <li>Immunity</li> </ul>	<ul style="list-style-type: none"> <li>EN 55011 / CISPR-11</li> <li>EN/IEC 61326-1 (Industry)</li> </ul>

<sup>1)</sup> Storing the rechargeable battery above 45 °C reduces its lifespan

Table 12-12 Process medium conditions

Description	Specification
Process medium temperature (T <sub>s</sub> ) (min to max)	-50 °C to +200 °C (-58 °F to 492 °F)
Process medium viscosity	Non-compressible liquids

## 12.6 Approvals

UL 61010-1 3rd Edition CAN/CSA-C22.2 No. 61010-1, 3rd Edition EN61010-1: 2010

## 12.7 SensorFlash

Table 12-13 SensorFlash

Description	Specification	
	SD card (S-300u)	SD card (Class 4 with adapter)
Capacity	4 GB	4 GB
File system support	FAT32 / 8.3	FAT32 / 8.3
Temperature range		
Operation:	-40 °C to +85 °C (-40 °F to 185 °F)	-25 °C to +85 °C (-13 °F to 185 °F)
Storage:	-40 °C to +100 °C (-40 °F to 212 °F)	-40 °C to +85 °C (-40 °F to 185 °F)

---

**Note**

**SensorFlash functions support**

Only the supplied 4 GB SD cards are supported for backup, restore, logging, and firmware update.

---



## Dimension drawings

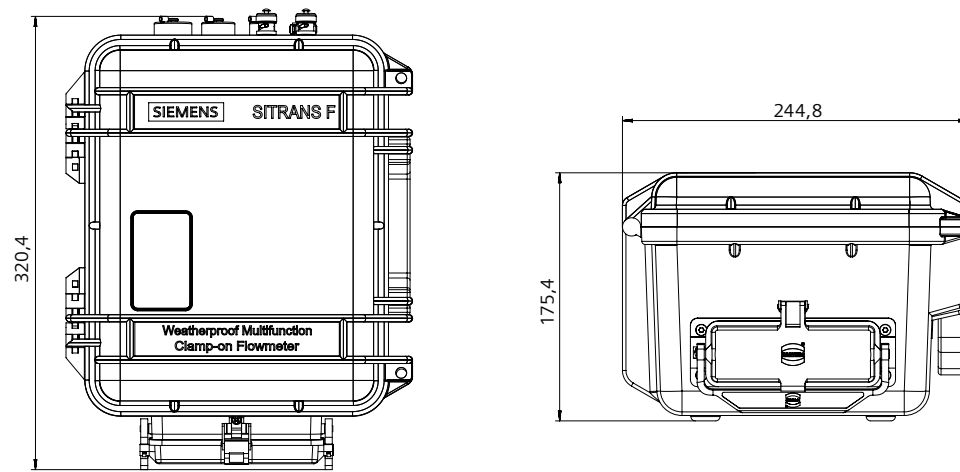

Figure 13-1 Dimensions



# Modbus communication

## A.1 Modbus addressing model

The device allows read/write access to the following standard Modbus RTU data holding register blocks:

- Holding registers (ref. 4x address range)

The minimum value of a writable **holding register** can be read by adding 10000 to the Modbus address of the register.

The maximum value of a writable **holding register** can be read by adding 20000 to the Modbus address of the register.

The default value of a writable **holding register** can be read by adding 30000 to the Modbus address of the register.

## A.2 Modbus function codes

This device supports following function codes: 3, 8 and 16.

Function codes 3 and 16 are used for accessing registers, max. 16 registers per read/write request is accepted.

Function code 8 is used for reading Modbus communication diagnostic information.

Below the various function code are described.

### Function code 3 (Read holding registers)

#### General exceptions:

- Requesting less than 1 or more than 16 registers => Exception 3 (Illegal data value)
- Requesting invalid start address or start address with invalid quantity => Exception 2 (Illegal data address)

#### Application exceptions:

- Application errors; min/max limit of parameter exceeded; or parameter write-protected => Exception 4 (Slave device error)

#### Holes/register alignment:

- The read command always returns data if no exception is given.
- Holes in the holding register map return value zero in all bytes. E.g. reading 2 registers starting at 4:0004 above will result in 2 bytes of "float B" followed by 2 zeroes.

### Function code 3 example

#### Query

Slave address	1 byte
Function	1 byte
Starting Address Hi	1 byte
Starting Address Lo	1 byte
Quantity of Registers Hi	1 byte
Quantity of Registers Lo	1 byte
CRC	2 bytes

#### Response

Slave address	1 byte
Function	1 byte
Byte count	1 byte
Register Value Hi	1 byte
Register Value Lo	1 byte
:	:
Register Value Hi	1 byte
Register Value Lo	1 byte
CRC	2 bytes

#### Example: Read absolute massflow (address 3000)

**Query:** 1,3,11,184,0,2,70,10

Slave address = 1 (0x01)  
 Function = 3 (0x03)  
 Starting Address Hi, Lo = 11, 184 (0x0B,0xB8)  
 Quantity of Registers Hi, Lo = 0, 2 (0x00,0x02)  
 CRC = 70,10 (0x46, 0x0A)

Starting address 0x0BB8 = 3000  
 Quantity of registers = 0x0002 = 2

**Response:** 1,3,4,64,195,82,139,98,200

Slave address = 1 (0x01)  
 Function = 3 (0x03)  
 Byte Count = 4 (0x04)  
 Register 1 - Register Value Hi, Lo = 64, 195 (0x40, 0xC3)  
 Register 2 - Register Value Hi, Lo = 82, 139 (0x52, 0x93)  
 CRC = 98,200 (0x62, 0xC8)

Absolute mass flow = 0x40C35293 = 6.10383 kg/sec



## Function code 16 (Write multiple registers)

### General exceptions

- Writing less than 1 or more than 16 registers => Exception 3 (Illegal data value)
- If ByteCount is not exactly 2 times NoOfRegisters => Exception 3 (Illegal data value)
- Requesting invalid start address or start address with invalid quantity => Exception 2 (Illegal data address)

### Application exceptions:

- Application errors; min/max limit of parameter exceeded; or parameter write-protected => Exception 4 (Slave device error)
- Application errors include writing to ReadOnly holding registers

### Holes/register alignment:

- If start-address is not the start of a mapped holding register => Exception 2 (Illegal data address)
- Writing to holes is allowed (ie ignored - and no exception occurs) - except for the condition described above
- If the end address is only part of a mapped holding register item (e.g. one half of a float value), the action depends on the data type. Writing parts of all data types => Exception 4 (Slave device error)

## Function code 16 example

### Query

Slave address	1 byte
Function	1 byte
Starting Address Hi	1 byte
Starting Address Lo	1 byte
Quantity of Registers Hi	1 byte
Quantity of Registers Lo	1 byte
Byte Count	1 byte
Registers Value Hi	1 byte
Registers Value Lo	1 byte
:	:
Registers Value Hi	1 byte
Registers Value Lo	1 byte
CRC	2 bytes

### Response

Slave address	1 byte
Function	1 byte
Starting Address Hi	1 byte

A.2 Modbus function codes

Starting Address Lo	1 byte
Quantity of Registers Hi	1 byte
Quantity of Registers Lo	1 byte
CRC	2 bytes

**Example: Set baud rate to 115200 baud (address 529)**

**Query:** 1,16,2,17,0,1,2,0,5,70,210

Slave address = 1 (0x01)  
 Function = 16 (0x10)  
 Starting Address Hi, Lo = 2, 17 (0x02,0x11)  
 Quantity of Registers Hi, Lo = 0, 1 (0x00,0x01)  
 Byte Count = 2 (0x02)  
 Registers Value Hi, Lo = 0, 5 (0x00,0x05)  
 CRC = 70,10 (0x46, 0x0A)

Starting address 0x0211 = 529  
 Number of registers = 0x0001 = 1  
 Data 0x0005 = (115200 = value 5)

**Response:** 1,16,2,17,0,1,80,116

Slave address = 1 (0x01)  
 Function = 16 (0x10)  
 Starting Address Hi, Lo = 2, 17 (0x02,0x11)  
 Quantity of Registers Hi, Lo = 0, 1 (0x00,0x01)  
 CRC = 80,116 (0x50, 0x74)

**Function code 8 (Diagnostics)**

Modbus function code 8 provides a series of tests for checking the communication system between a client (Master) device and a server (Slave).

The following diagnostics functions are supported:

Sub-function code (Dec)	Name	Description
00	Return Query Data	The data passed in the request data field is to be returned (looped back) in the response.
10	Clear Counters and Diagnostic Register	Clears all counters and the diagnostic register. Counters are also cleared upon power-up.
11	Return Bus Message Count	The response data field returns the quantity of messages that the remote device has detected on the communications system since its last restart, clear counters execution, or power-up.
12	Return Bus Communication Error Count	The response data field returns the quantity of CRC errors encountered by the remote device since its last restart, clear counters execution, or power-up.

Sub-function code (Dec)	Name	Description
13	Return Bus Exception Error Count	The response data field returns the quantity of MODBUS exception responses returned by the remote device since its last restart, clear counters execution, or power-up.
14	Return Slave Message Count	The response data field returns the quantity of messages broadcast or addressed to the remote device that the remote device has processed since its last restart, clear counters execution, or power-up.
15	Return Slave No Response Count	The response data field returns the quantity of messages addressed to the remote device for which it has returned no response (neither a normal response nor an exception response), since its last restart, clear counters execution, or power-up.
16	Return Slave NAK Count	The response data field returns the quantity of messages addressed to the remote device for which it returned a Negative Acknowledge (NAK) exception response, since its last restart, clear counters execution, or power-up.
17	Return Slave Busy Count	The response data field returns the quantity of messages addressed to the remote device for which it returned a Slave Device Busy exception response, since its last restart, clear counters execution, or power-up.
18	Return Bus Character Overrun Count	The response data field returns the quantity of messages addressed to the remote device that it could not handle due to a character overrun condition, since its last restart, clear counters execution, or power-up.
20	Clear Overrun Counter and Flag	Clears the overrun error counter and resets the error flag.

## Function code 8 example

### Query

Slave address	1 byte
Function	1 byte
Sub-function Hi	1 byte
Sub-function Lo	1 byte
Data Hi	1 byte
Data Lo	1 byte
:	:
Data Hi	1 byte
Data Lo	1 byte
CRC	2 bytes

### Response

Slave address	1 byte
Function	1 byte

A.3 Changing Modbus communication settings

Sub-function Hi	1 byte
Sub-function Lo	1 byte
Data Hi	1 byte
Data Lo	1 byte
:	:
Data Hi	1 byte
Data Lo	1 byte
CRC	2 bytes

**Example: Read Return Slave Message Count (address 529)**

**Query:** 1,8,0,14,0,0,129,200

Slave address = 1 (0x01)  
 Function = 8 (0x08)  
 Sub-function Hi, Lo = 0, 14 (0x00,0x0E)  
 Data Hi, Lo = 0, 0 (0x00,0x00)  
 CRC = 129,200 (0x81, 0xC8)

Sub-function 0x000E = 14 = Read Return Slave Message Count

**Response:** 1,8,0,14,0,97,64,32

Slave address = 1 (0x01)  
 Function = 8 (0x08)  
 Sub-function Hi, Lo = 0, 14 (0x00,0x0E)  
 Data Hi, Lo = 0, 97 (0x00,0x65)  
 CRC = 64,32 (0x41, 0xE3)

Read Return Slave Message Count = 0x0065 = 97 message received

### A.3 Changing Modbus communication settings

Changing communication parameters, for example **Baud Rate, Modbus Parity Framing or Bus Address** effects the Modbus communication as follows:

- The new settings have effect only after a reset, either by restarting the device or writing the value 1 to Modbus address 600 **Restart communication**.
- The new settings will not have effect until the Modbus driver has responded to any ongoing Modbus request.

**NOTICE**

**Setting addresses in a multidrop network**

It is recommended NOT to use the default address in a multi-drop network. When setting device addresses, make sure that each device has a unique address. Replication of addresses may cause abnormal behavior of the entire serial bus and make the master unable to communicate with all slaves on the bus.

## A.4 Modbus communication

Table A-1 General Modbus settings

Modbus register	Data type / Size in bytes	Parameter	Description	Default value [units] (units register)	Value range / Setting options	Access level
8291	Unsigned / 2	Restart communication	Restarts the communication using configured slave address, baud rate and parity/framing.	-	<ul style="list-style-type: none"> <li>0: Cancel</li> <li>1: Restart</li> </ul>	Write only
8005	Unsigned / 2	Slave address (HW)	DIP switch setting on the transmitter cassette. Address is used if DIP switch is set to a value > 0.	-	-	Read only
8297	Unsigned / 2	Slave address (SW)	Software address of Modbus interface. Address is used if switch is set to 0.	1	1 - 147	Read / write
8298	Unsigned / 2	Baud rate	Baud rate of Modbus interface.	19200 Bit/s	<ul style="list-style-type: none"> <li>0: 9600 Bit/s</li> <li>1: 19200 Bit/s</li> <li>2: 115200 Bit/s</li> <li>3: Reserved</li> <li>4: 38400 Bit/s</li> <li>5: 57600 Bit/s</li> <li>6: 76800 Bit/s</li> <li>7: 1200 Bit/s</li> <li>8: 2400 Bit/s</li> <li>9: 4800 Bit/s</li> </ul>	Read / write
8299	Unsigned / 2	Parity and framing	Parity and framing of the Modbus communication interface.	Even parity, 1 stop	<ul style="list-style-type: none"> <li>0: Even parity, 1 stop</li> <li>1: Odd parity, 1 stop</li> <li>2: No parity, 2 stops</li> <li>3: No parity, 1 stop</li> </ul>	Read / write

## A.5 Coil configuration

The device provides 20 coil definitions which can be configured.

Table A-2 Coil configuration

Modbus register	Data type / Size in bytes	Parameter	Description	Default value [units] <sup>1</sup> (units register)	Value range / Setting options	Access level
10300	Unsigned / 2	Modbus coil address 1	Specifies the coil address with which the following bit coded register value is accessible. The register and bit(s) are specified by Modbus coil register 1 and Modbus coil bitmask 1	1	0 - 65535	Read / write
10301	Unsigned / 2	Modbus coil register 1	Specifies the Modbus register whose value is checked against Modbus coil bitmask 1 to determine the coil value (false or true). A register value of 65535 specifies that this coil mapping is undefined.	Undefined	0 - 65535	Read / write
10302	Unsigned / 4	Modbus coil bitmask 1	Bit mask which is compared against the register value specified with Modbus coil register 1 to determine the coil value. If any bit of the register value is set which is also set in the bit mask then the coil value is true, otherwise the coil is false.	0	0 - 4294967295	Read / write
10304	Unsigned / 2	Modbus coil length 1	Output parameter that informs about the size in bytes of the parameter that is specified by Modbus coil address 1. Could be used to identify the relevant bits of the Modbus coil bitmask 1	-		Read only
10305	Unsigned / 2	Modbus coil address 2	Specifies the coil address with which the following bit coded register value is accessible. The register and bit(s) are specified by Modbus coil register 2 and Modbus coil bitmask 2	2	0 - 65535	Read / write
10306	Unsigned / 2	Modbus coil register 2	Specifies the Modbus register whose value is checked against Modbus coil bitmask 2 to determine the coil value (false or true). A register value of 65535 specifies that this coil mapping is undefined.	Undefined		Read / write

Modbus register	Data type / Size in bytes	Parameter	Description	Default value [units] <sup>1</sup> (units register)	Value range / Setting options	Access level
10307	Unsigned / 4	Modbus coil bit-mask 2	Bit mask which is compared against the register value specified with Modbus coil register 2 to determine the coil value. If any bit of the register value is set which is also set in the bit mask then the coil value is true otherwise false.	0	0 - 4294967295	Read / write
10309	Unsigned / 2	Modbus coil length 2	Output parameter that informs about size in bytes of parameter that is specified by Modbus coil address 2. Could be used to identify the relevant bits of the Modbus coil bitmask 2	-		Read only
...						
10399	Unsigned / 2	Modbus coil length 20	Output parameter that informs about the size in bytes of the parameter that is specified by Modbus coil address 20. Could be used to identify the relevant bits of the Modbus coil bitmask 20	-		Read only

<sup>1</sup> If default value is "-" the command "Set to default" will not set this parameter to default.

## A.6 Modbus register mapping

The device provides the possibility to map each existing parameter to a freely chosen Modbus register for communication purposes over channel 1.

A.6 Modbus register mapping

The device provides means to remap 20 Modbus registers.

Table A-3 Modbus register mapping

Modbus register	Data type / Size in bytes	Parameter	Description	Default value [units] (units register)	Value range / Setting options	Access level
10448	Unsigned / 4	Enable mapping	Activation/deactivation of the register mapping. A set bit means that the mapping pair is activated, a cleared bit that the mapping pair is deactivated. Bit 0: Requested register 1 / Target register 1 ... Bit 19: Requested register 20 / Target register 20	0	0 - 1048575	Read / write
10450	Unsigned / 2	Register 1 source	Modbus register that appears within Modbus request is redirected to the parameter specified by Target register 1	65535	0 - 65535	Read / write
10451	Unsigned / 2	Register 1 target	Register of an existing product parameter to which a Modbus request is redirected	65535	0 - 65535	Read / write
...						
10488	Unsigned / 2	Register 20 source	Modbus register that appears within Modbus request is redirected to the parameter specified by Target register 20	65535	0 - 65535	Read / write
10489	Unsigned / 2	Register 20 target	Register of an existing product parameter to which a Modbus request is redirected	65535	0 - 65535	Read / write



## A.7 Integer byte order

The device is able to adjust the byte order of integer values.

Table A-4 Integer byte order

Modbus register	Data type / Size in bytes	Parameter	Description	Default value [units] (units register)	Value range / Setting options	Access level
8295	Unsigned / 2	Integer order byte	The integer byte order used in Modbus messages. 0: MSB - LSB (big endian) 1: LSB - MSB (little endian) MSB = most significant byte / high byte LSB = least significant byte / low byte	MSB - LSB (big endian)	0 - 1	Read / write

## A.8 Float byte order

The device is able to adjust the byte order of floating-point values.

Table A-5 Float byte order

Modbus register	Data type / Size in bytes	Parameter	Description	Default value [units] (units register)	Value range / Setting options	Access level
8296	Unsigned / 2	Float byte order	The float byte order used in Modbus messages. 0: 1-0-3-2 1: 0-1-2-3 2: 2-3-0-1 3: 3-2-1-0 The first mentioned byte is the first byte sent. Byte 3 corresponds to the left-most byte (MSB) of a 32 bit floating point number in big endian format, byte 0 to the right-most byte	3-2-1-0	0 - 3	Read / write

## A.9 Modbus function codes

Table A-6 General Modbus settings

Function code	Command text	Description
01	Read Coils	Reads the status of single bit(s)
02	Read Discrete Inputs	Reads the status of single input bit(s)
03	Read Holding Registers	Reads the binary content of multiple 16-bit registers
04	Read Input Registers	Reads the binary content of multiple 16-bit registers
05	Write Single Coil	Writes a single on/off bit
06	Write Single Register	Writes the binary content of single 16-bit register
07	Read Exception Status	Delivers the global alarm status of the device
08	Diagnostics	Provides a series of tests for checking the communication system
15	Write Multiple Coils	Writes multiple on/off bits
16	Write Multiple Registers	Writes the binary content of multiple 16-bit registers
17	Report Slave ID	The device will respond to a Report Slave ID command (command 17) request from the master by giving information about device type, vendor, and revision level
23	Read/Write Multiple Registers	Combined Write Multiple Registers / Read Holding Registers call

### Function code 7 (Read exception status)

The device provides the content of the parameter Global alarm status as exceptions.

### Function code 8 (Diagnostics)

The diagnostics function provides means for checking the communication between MODBUS master and slave. The function uses a sub-function code to select the functionality.

The following sub-function codes are supported:

Sub-function code	Name	Description
0	Return query data	The data passed in the request data field will be returned (looped back) in the response. The entire response message should be identical to the request.
1	Restart communications option	After having restarted the communication, select the baudrate, framing or Modbus address to get access to the device again.

### Function code 17 (Report Slave ID)

The transmitter will respond to a Report Slave ID request from the master by giving information about device type, vendor, and firmware version in a format as shown:

Response

Slave address	1 byte	
Function code	1 byte	17
Byte count	1 byte	62
Slave ID	1 byte	Sensor device type 0: SITRANS FS
Run indicator	1 byte	255: Running

Manufacturer name	12 bytes	SIEMENS
Product name	32 bytes	SITRANS F
Product firmware version	16 bytes	-
CRC	2 bytes	

## A.10 Access control

Access control manages whether the Modbus master is allowed to modify device parameters. Reading of parameters is always possible. The general access control rules are:

- The Modbus interface has an access level that can be changed by providing PIN information via the Modbus register 8292 (User PIN) or 8293 (Expert PIN).
- Each parameter has a protection level assigned that specifies the required access level to modify the parameter via the Modbus interface.
- If the access level of the Modbus interface is lower than the protection level of the parameter that is desired to be modified, then the attempt to modify the parameter is rejected by the device.

Table A-7 Access control

Access level	Description
Read only	The Modbus master is not able to modify the device configuration (setup parameters). The Modbus master is only able to execute the command, to reset PINs. This is the default level of the Modbus interface.
User	The Modbus master has to provide the correct user PIN with Modbus register 8292 to reach this access level. The Modbus master is able to modify a subset of the device configuration.
Expert	The Modbus master has to provide the correct expert PIN with Modbus register 8293 to reach this access level. The Modbus master is able to modify the configuration of the device.

If an incorrect user PIN or an incorrect expert PIN is entered, or if the device does not receive any request within 10 minutes, the device resets the access level to read only.



# Product documentation and support

## B.1 Product documentation

Process instrumentation product documentation is available in the following formats:

- Certificates (<http://www.siemens.com/processinstrumentation/certificates>)
- Downloads (firmware, EDDs, software) (<http://www.siemens.com/processinstrumentation/downloads>)
- Catalog and catalog sheets (<http://www.siemens.com/processinstrumentation/catalogs>)
- Manuals (<http://www.siemens.com/processinstrumentation/documentation>)  
You have the option to show, open, save, or configure the manual.
  - "Display": Open the manual in HTML5 format
  - "Configure": Register and configure the documentation specific to your plant
  - "Download": Open or save the manual in PDF format
  - "Download as html5, only PC": Open or save the manual in the HTML5 view on your PC

You can also find manuals with the Mobile app at Industry Online Support (<https://support.industry.siemens.com/cs/ww/en/sc/2067>). Download the app to your mobile device and scan the device QR code.

### Product documentation by serial number

Using the PIA Life Cycle Portal, you can access the serial number-specific product information including technical specifications, spare parts, calibration data, or factory certificates.

#### Entering a serial number

1. Open the PIA Life Cycle Portal (<https://www.pia-portal.automation.siemens.com>).
2. Select the desired language.
3. Enter the serial number of your device. The product documentation relevant for your device is displayed and can be downloaded.

To display factory certificates, if available, log in to the PIA Life Cycle Portal using your login or register.

#### Scanning a QR code

1. Scan the QR code on your device with a mobile device.
2. Click "PIA Portal".

To display factory certificates, if available, log in to the PIA Life Cycle Portal using your login or register.

## B.2 Technical support

### Technical support

If this documentation does not completely answer your technical questions, you can enter a Support Request (<http://www.siemens.com/automation/support-request>).

For help creating a support request, view this video here.

Additional information on our technical support can be found at Technical Support (<http://www.siemens.com/automation/csi/service>).

### Service & support on the Internet

In addition to our technical support, Siemens offers comprehensive online services at Service & Support (<http://www.siemens.com/automation/serviceandsupport>).

### Contact

If you have further questions about the device, contact your local Siemens representative at Personal Contact (<http://www.automation.siemens.com/partner>).

To find the contact for your product, go to "all products and branches" and select "Products & Services > Industrial automation > Process instrumentation".

Contact address for business unit:

Siemens AG  
Digital Industries  
Process Automation  
Östliche Rheinbrückenstr. 50  
76187 Karlsruhe, Germany

# Remote operation

## C.1 SIMATIC PDM

### C.1.1 Overview SIMATIC PDM

SIMATIC PDM (Process Device Manager) is a general-purpose, manufacturer-independent tool for the configuration, parameter assignment, commissioning, diagnostics and maintenance of intelligent field devices and field components. Follow-up installations and additional information on SIMATIC PDM are available on the Internet at SIMATIC PDM (<https://www.siemens.com/simatic-pdm>).

SIMATIC PDM monitors the process values, alarms and status signals of the device. It allows you to display, compare, adjust, verify, and simulate process device data; also to set schedules for calibration and maintenance.

For information on, for example, how to install and integrate devices, commission the software, see Operating Manual 'Help for SIMATIC PDM'. The manual is delivered with SIMATIC PDM software. Once the SIMATIC PDM is installed on your computer you find the manual under: Start > All programs > Siemens Automation > SIMATIC > Documentation. Link at our website: SIMATIC PDM instructions and manuals (<https://support.industry.siemens.com/cs/ww/en/ps/16983/man>).

---

#### Note

##### Field device parameters

- For a list of parameters and additional information, consult section "HMI menu structure (Page 105)".
  - The field device remains in measurement mode during the time you configure the field device.
- 

### C.1.2 Check SIMATIC PDM version

#### Procedure

1. Go to SIMATIC PDM Download (<http://www.siemens.com/simaticpdm/downloads>).
2. Check the support page to make sure you have:
  - The latest version of SIMATIC PDM
  - The most recent Service Pack (SP)
  - The most recent hot fix (HF)

### C.1.3 Updating the Electronic Device Description (EDD)

#### Procedure

1. Check that the EDD revision match the Firmware revision in the device according to the table in section Product compatibility (Page 9).
2. Go to the support page Software downloads (<https://www.siemens.com/processinstrumentation/downloads>).
3. Enter the product name in the field "Enter search term...".
4. Download the most current EDD of your device.
5. Save files to your computer in an easily accessed location.
6. Launch SIMATIC PDM – Device Integration Manager.  
From the File menu, click "Read device descriptions from compressed source...".
7. Browse to the zipped EDD file, select and open it.
8. Use the "Integration" function to integrate the EDD into the device catalog. The EDD is now accessible via SIMATIC Manager.



## HMI menu structure

An overview of the HMI menu structure is available for download under this link (<https://support.industry.siemens.com/cs/document/109804533/menu-structure-of-the-sitrans-fst020-and-sitrans-fst090?dti=0&pnid=24980&lc=en-US>).

---

**Note****Visibility of menus/parameters**

The visibility of some parameter/menu items depends on previous selections. For example, if Frequency is selected on the output, only the frequency setup parameter/menu items are visible. The parameter/menu items for setting the current output, pulse output, and status output are hidden.

---



# Index

## A

AC Power  
    Power Adapter/Charger, 30  
Access control, 99

## B

Basic Requirements, 24  
Battery unit, 72

## C

Catalog  
    catalog sheets, 101  
Certificates, 13, 101  
Cleaning, 68  
Coil configuration, 94  
Commissioning  
    via HMI, 41  
    Wizard, 41  
Current output, 80  
Customer Support, (Refer to Technical support)

## D

Design  
    Wall mount housing transmitter, 81  
Designated use, 81  
Digital input, 79  
Disassembly, 24  
Disposal, 73  
Document history, 9  
Downloads, 101

## F

Float byte order, 97

## G

General Modbus settings, 93, 98

## H

Hazardous area  
    Laws and directives, 13  
Hotline, (Refer to Support request)

## I

Icons, (see Symbol)  
Input/output, 80  
Inputs and outputs, 57  
Installation torques, 81  
Integer byte order, 97

## L

Laws and directives  
    Disassembly, 13  
    Personel, 13  
Lithium batteries, 72  
    Return, 73  
    Safety, 15

## M

Maintenance, 67  
    device status symbols, 75  
Manuals, 101  
Modbus holding registers  
    Access control, 99  
    Coil configuration, 94  
    Float byte order, 97  
    General Modbus settings, 93, 98  
    Integer byte order, 97  
    Modbus register mapping, 96  
Modbus register mapping, 96  
Modifications  
    correct usage, 14  
    improper, 14

## O

Operating conditions  
    Basic conditions, 82  
    Process medium conditions, 82

## P

Parameter view, 50  
Power supply, 79

## R

Relay output, 80  
Return procedure, 73

## S

Scope of delivery, 10  
SensorFlash, 82  
Service, 102  
Service and support  
  Internet, 102  
Support, 102  
Support request, 102  
Symbol  
  configuration, 75  
  device status, 75  
  diagnostics, 75  
  maintenance, 75  
  operating mode, 75  
  process value, 75  
Symbols, (Refer to warning symbols)  
System design, 81

## T

Technical data, 79, 82  
  Current output, 80  
  Designated use, 81  
  Digital input, 79  
  Input/output, 80  
  Installation torques, 81  
  Operating conditions, 82  
  Power supply, 79  
  Relay output, 80  
  System design, 81  
Technical support, 102  
  partner, 102  
  personal contact, 102  
Test certificates, 13

## V

Views  
  parameter, 50

## W

Warning symbols, 13  
Warranty, 12