

PH91 Portable pH Meter PH92 Portable pH/ORP Meter

IM 12B03E00-02EN



◆ Introduction

Thank you for purchasing the PH91/PH92 Portable pH/ORP Meter.

This user's manual contains all essential information for the user to make full use of the PH91/PH92.

Please read the following respective documents before using the PH91/PH92.

The related documents are listed as follows.

User's Manual

Contents	Document number	Note
PH91 Portable pH Meter PH92 Portable pH/ORP Meter Start-up and Safety Precautions	IM 12B03E00-01EN	Printed manual
PH91 Portable pH Meter PH92 Portable pH/ORP Meter User's manual	IM 12B03E00-02EN	Online manual (This manual)

"EN" in the document number is the language code.

An exclusive User's Manual might be attached to the products whose suffix codes or option codes contain the code "Z" (made to customers' specifications). Please read it along with this manual.

You can download the latest documents from our website.

<https://www.yokogawa.com/an/ph91orp92/>



■ Product safety tips



WARNING

- Do NOT use this instrument where there is a possibility of electrical shock.
- Do NOT touch any part of the electrode immediately after using in very hot liquids. Otherwise, you may get burned.
- The product contains devices that can be damaged by electrostatic discharge. When inserting batteries and connecting a sensor, take care to prevent such a damage.

- The Instrument is packed carefully with shock absorbing materials, nevertheless, the instrument may be damaged or broken if subjected to strong shock, such as if the instrument is dropped. Handle with care.
- Do not use abrasives or organic solvents.



CAUTION

- Do not apply physical shock or excessive force to the glass sensor, or it may break.
- If the meter will not be used for an extended period of time, be sure to remove the batteries. Otherwise battery leakage may occur, causing damage to or malfunction of the meter.
- Use both meters and sensors made by YOKOGAWA. Otherwise, it will result not only voiding of our warranty, but also may impair the safety and performance of the instrument.

■ Notes on Handling User's Manuals

- Please hand over the user's manuals to your end users so that they can keep the user's manuals on hand for convenient reference.
- Please read the information thoroughly before using the product.
- The purpose of these user's manuals is not to warrant that the product is well suited to any particular purpose but rather to describe the functional details of the product.
- No part of the user's manuals may be transferred or reproduced without prior written consent from YOKOGAWA.
- YOKOGAWA reserves the right to make improvements in the user's manuals and product at any time, without notice or obligation.
- If you have any questions, or you find mistakes or omissions in the user's manuals, please contact our sales representative or your local distributor.

■ Drawing Conventions

Some drawings may be partially emphasized, simplified, or omitted, for the convenience of description.

Some screen images depicted in the user's manual may have different display positions or character types (e.g., the upper / lower case). Also note that some of the images contained in this user's manual are display examples.

Flashing indication is represented by a pale color.

■ Trademark Notices

All other company and product names mentioned in this user's manual are trademarks or registered trademarks of their respective companies.

We do not use TM or ® mark to indicate those trademarks or registered trademarks in this user's manual.

■ Product disposal

Disposal of the product must be carried out in accordance with local and national laws/regulations.

■ Battery disposal

Batteries must be disposed of in accordance with local and national laws/regulations.

■ Warranty and service

YOKOGAWA products and parts are guaranteed free from defects in workmanship and material under normal use and service for a period of (typically) 12 months from the date of shipment from the manufacturer.

Individual sales organizations can deviate from the typical warranty period, and the conditions of sale relating to the original purchase order should be consulted. Damage caused by wear and tear, inadequate maintenance, corrosion, or by the effects of chemical processes are excluded from this warranty coverage.

For warranty claims for replacement or repair (at our discretion), please contact our sales representative. We will replace or repair at our discretion. The following information must be included in the letter accompanying the returned goods:

- Part number, model code and serial number
- Original purchase order and date
- Length of time in service and a description of the process
- Description of the fault, and the circumstances of failure
- Process/environmental conditions that may be related to the failure of the device.
- Warranty coverage statement: In-warranty or out-of-warranty repairs

Returned goods that have been in contact with process fluids must be decontaminated/disinfected before shipment. Goods should carry a certificate to this effect, for the health and safety of our employees.

Material safety data sheets should also be included for all components of the processes to which the equipment has been exposed.

◆ Safety Precautions

■ Safety, Protection, and Modification of the Product

- In order to protect the system controlled by the product and the product itself and ensure safe operation, observe the safety precautions described in this user's manual. We assume no liability for safety if users fail to observe these instructions when operating the product.
- If this instrument is used in a manner not specified in this user's manual, the protection provided by this instrument may be impaired.
- If any protection or safety circuit is required for the system controlled by the product or for the product itself, prepare it separately.
- Be sure to use the spare parts approved by Yokogawa Electric Corporation (hereafter simply referred to as YOKOGAWA) when replacing parts or consumables.
- Modification of the product is strictly prohibited.
- The following safety symbols are used on the product as well as in this manual.



WARNING

This symbol indicates that an operator must follow the instructions laid out in this manual in order to avoid the risks, for the human body, of injury, electric shock, or fatalities. The manual describes what special care the operator must take to avoid such risks.



CAUTION

This symbol indicates that the operator must refer to the instructions in this manual in order to prevent the instrument (hardware) or software from being damaged, or a system failure from occurring.

CAUTION

This symbol gives information essential for understanding the operations and functions.

NOTE

This symbol indicates information that complements the present topic.

■ Warning and Disclaimer

The product is provided on an “as is” basis. YOKOGAWA shall have neither liability nor responsibility to any person or entity with respect to any direct or indirect loss or damage arising from using the product or any defect of the product that YOKOGAWA can not predict in advance.



Compliant Standards

EMC:

CE: EN 61326-1 Class B Table 1 (For use in a basic electromagnetic environment)

EN IEC 61326-1 Class B Table 1 (For use in a basic electromagnetic environment)

Influence of immunity environment (Criteria A): change of reading value is specified within $\pm 0.07\text{pH}$

RCM: EN 61326-1 Class B, Table 1

KC: KS C 9610-6-2, KS C 9811

Environmental regulation:

RoHS Directive: EN IEC 63000

WEEE Directive: DIRECTIVE 2012/19/EU

REACH : Regulation(EC) 1907/2006

◆ CE marking products

■ Authorized Representative in EEA

The Authorized Representative for this product in EEA is Yokogawa Europe B.V. (Euroweg 2, 3825 HD Amersfoort, The Netherlands).

■ Identification Tag

This manual and the identification tag attached on packing box are essential parts of the product. Keep them together in a safe place for future reference.

■ Users

This product is designed to be used by a person with specialized knowledge.

■ Batteries

Prepare 2 batteries that type is AA (LR6) 1.5V by yourself since batteries are not included in this product. If required, please select batteries with the authorized certification mark for each country. The batteries should be disposed of in accordance with local and national legislation/regulations.

■ Waste Electrical and Electronic Equipment (WEEE)

(Only valid in the EU for EU WEEE Directive)



This product complies with the WEEE marking requirement.

This marking indicates that you must not discard this electrical/electronic product in domestic household waste.

When disposing of products in the EEA, contact your local Yokogawa office in the EEA.

◆ Control of Pollution Caused by the Product

This is an explanation for the product based on “Control of Pollution caused by Electronic Information Products” in the People’s Republic of China.

产品中有害物质的名称及含量

部件名称	有害物质					
	铅 (Pb)	汞 (Hg)	镉 (Cd)	六价铬 (Cr (VI))	多溴联苯 (PBB)	多溴二苯醚 (PBDE)
本体	×	○	○	○	○	○
传感器 (PH92SN,OR92SN,SC92SN)	×	×	×	×	○	○
电缆	×	○	○	○	○	○

○：表示该有害物质在该部件中所有均质材料中的含有量都在GB/T26572所规定的限量要求以下。

×：表示该有害物质至少在该部件的某一均质材料中的含有量超出GB/T26572所规定的限量要求。

环保使用期限：这个标志是基于SJ/T11364，在中国（不包括台湾，香港，澳门）贩售的电子电器产品所适用的环保使用期限。



只要遵守产品上关于安全及使用上的注意事项，从制造之日起计算在该年限内，不会发生制品内的有害物质外泄，突然变异，对环境或人体以及财产产生重大影响的情况。

（注）该年限是《环境保护使用期限》，不是产品的保质期限。

另外，关于替换部件的推荐替换周期，请阅读使用说明书。

◆ KC marking Product

- (1) Trade Name : Yokogawa Electric Corp.
- (2) Model Name : See table below.
- (3) Date of Manufacturer : See name plate of product.
- (4) Manufacturer : Yokogawa Electric Corp.
- (5) Country of origin : Singapore

Model	Model Name	Registration Website URL
PH91	Portable pH Meter	http://www.rra.go.kr/selform/YHQ-EEN529-1
PH92	Portable pH/ORP Meter	http://www.rra.go.kr/selform/YHQ-EEN529-2

PH91 Portable pH Meter

PH92 Portable pH/ORP Meter

IM 12B03E00-02EN 3rd Edition

CONTENTS

◆	Introduction.....	i
◆	Safety Precautions	iv
◆	Compliant Standards	v
◆	CE marking products	vi
◆	Control of Pollution Caused by the Product.....	vii
◆	KC marking Product.....	vii
1.	General Description	1-1
	1.1 Specifications.....	1-2
	1.2 Instrument Check.....	1-3
	1.3 Model and Suffix Codes	1-4
	1.4 Part Name and Functions	1-5
	1.5 Optional Accessories	1-9
	1.6 Dimensions.....	1-10
2.	Basic Operations	2-1
	2.1 Inserting the Batteries	2-1
	2.2 Connecting Sensor	2-2
	2.3 Changing Operation Mode.....	2-3
	2.4 Saving Data.....	2-4
3.	Measurement Mode (MEAS).....	3-1
4.	Setup Mode (SET).....	4-1
	4.1 pH Setup (PH)	4-1
	4.1.1 pH Buffer Standard (BUFF)	4-1
	4.1.2 Calibration interval alarm setup (C. ALr).....	4-2
	4.1.3 Erase calibration data (C.CLr)	4-3
	4.2 Data Setup (DATA)	4-4
	4.2.1 Data log interval setup (LOG)	4-4
	4.2.2 Erase all saved data (D.CLr).....	4-5
	4.3 General Setup (GEN)	4-5
	4.3.1 Stability check (STBL).....	4-6
	4.3.2 Auto power-off (A.Off)	4-7
	4.3.3 Reset the meter (r.SET)	4-8
5.	Calibration Mode (CAL)	5-1
	5.1 pH Calibration.....	5-1

5.2	Relative Value (RmV) Display of ORP	5-3
5.3	Temperature Calibration	5-4
6.	Data Mode (DATA)	6-1
7.	Storage and Maintenance.....	7-1
7.1	Storage.....	7-1
7.2	Meter Maintenance.....	7-2
7.3	Sensor Maintenance.....	7-2
7.3.1	How to clean the sensors.....	7-2
7.3.2	Refill KCl filling solution.....	7-4
7.3.3	Moistening glass electrodes	7-4
7.3.4	Check oxidation-reduction potential	7-5
8.	Trouble Shooting.....	8-1
	Revision Record.....	i

1. General Description

The PH91 Portable pH meter, PH92 Portable pH/ORP meter are easy to carry, highly accurate pH meters.

Equipped with electrode sensitivity diagnostic functions, the meters enable easily accurate measurement of pH and ORP (oxidation-reduction potential), and a data storage function allows for confirmation of past measurement data at any time.

In addition, water-resistant construction makes it safe to use even if it is accidentally dropped into water (press water, etc.), as well as for measurement in places where water drops may fall on it, like in the rain.

However, the main body is not completely sealed, so do not leave it in water for a long period of time or do not pour chemicals or other solutions on it.

● Key Features

- Clear large LCD display with back light
- Tough, handy portable meter, unbreakable plastic sensor
- Built-in sensor holder on the side
- Foldable back stand
- Visualized electrode diagnostic result for sensor sensitivity level
- 500 data memory
- Automatic Temperature Compensation (ATC), Manual Temperature Calibration (MTC)
- Auto-hold / Auto stable / Real-time measurement modes with stability indicators
- Auto power off function (time configurable: OFF, 1 to 30 minutes)
- 2 x AA batteries
- IP67 water ingress, dust-proof meter housing

1.1 Specifications

Measurement:	pH; ORP:	Hydrogen ion concentration of solution oxidation-reduction potential
Measuring range:	pH; ORP; Temperature;	0.00 to 14.00 pH -2000 to 2000 mV 0 to 80°C (with sensors) * (0 to 50°C when a KCl replenish-free type sensor and its sensor cable are immersed in water)
Display limit:	pH; ORP; Temperature;	-2.00 to 16.00 pH -2000 to 2000 mV (1 decimal place in -999 to 999 mV) -10.0 to 120.0°C
Repeatability (simulated input without sensor):	pH; ORP:	±0.01 pH ± 1 digit ± 0.3% of Reading (-999.9 to 999.9 mV; ± 0.3 mV)
Temperature accuracy:		Simulated input for main unit only; ± 0.5°C ± 1 digit Combined with sensors; ± 1°C (0 to 70°C), ± 1.3°C (above 70°C)
Display:		Digital LCD with backlight
Temperature compensation:		automatic, manual
Calibration:	pH; Temperature:	automatic (NIST, USA: 5 points maximum, DIN: 6 points maximum) manual (1 point)
Functions:		Display pH or ORP (mV) and solution temperature simultaneously, Electrode sensitivity level indicator, Stability check function, Data Memory (500 points)
Construction:		IP67
Safety certification:		CE, RCM
Connectable sensors:		PH92SN, OR92SN (to only PH92)
Wetted Material:		<ul style="list-style-type: none"> ●KCl replenish-free type combination pH sensor Polypropylene resin (sensor body, protective cover), Glass (glass electrode, temperature sensor protection tube), Ceramics (liquid junction), Silicon rubber (sensor seal), PVC (cable), rigid polyethylene (grip), Nylon 6 (cable bushings) ●KCl refillable type combination pH sensor Polypropylene resin (sensor body, protective cover), Glass (glass electrode, temperature sensor protection tube), Ceramics (liquid junction), Silicon rubber (sensor seal) ●KCl refillable type ORP sensor Polypropylene resin (sensor body, protective cover), Glass (glass electrode, temperature sensor protection tube), Ceramics (liquid junction), Silicon rubber (sensor seal), Platinum (electrode)
Solution conductivity:		50 µS/cm or more
Ambient temperature:		0 to 45°C
Dimensions:		Approximately H160 × W80 × D40 mm (not including connector part)
Weight:		Approximately 230 g (without batteries, sensor)
Power source:		2 x AA Alkaline batteries (LR6) Auto power off function (time configurable: 1 to 30 minutes)
Battery life:		Approximately 500 hours

1.2 Instrument Check

Upon delivery, unpack the instrument carefully and inspect it to ensure that it was not damaged during shipment. If damage is found, retain the original packing materials (including the outer box) and then immediately notify YOKOGAWA sales office.

■ Checking the model and suffix code

Check the model and suffix code on the name plate affixed to the back side of the meter and sensor cable as shown in Figure 1.1 Name plate example. See Model and suffix code in 1.3 Model and Suffix Codes

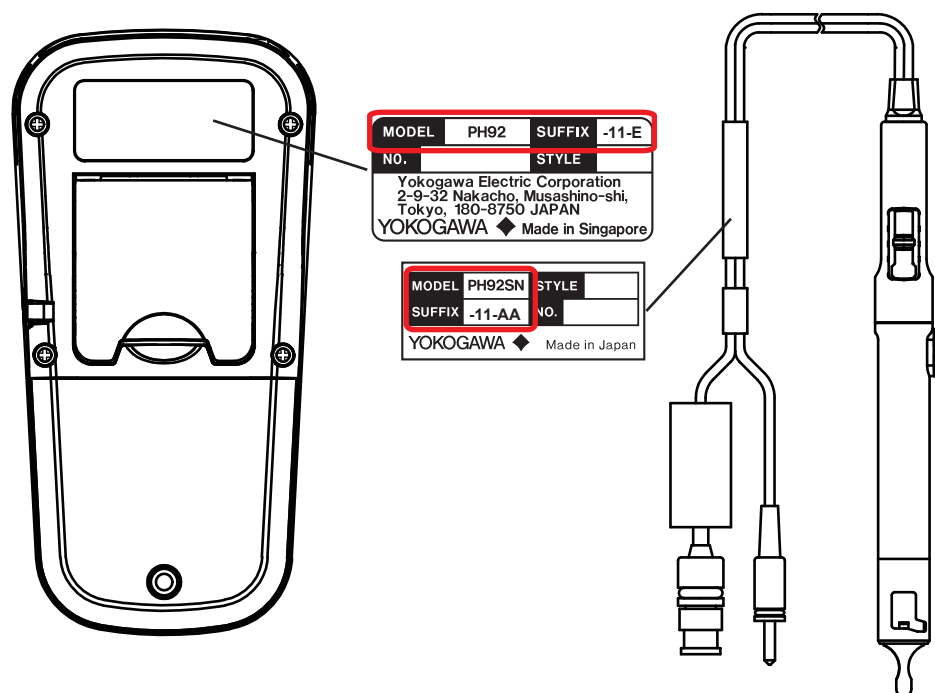

Figure 1.1 Name plate example

■ Checking package contents

Make sure the following parts as shown in Table 1.1 are included. See 1.3 Model and Suffix Codes to specify code for sensor connection.

Table 1.1 Standard accessories (✓: included)

Products	SUFFIX code for Connecting sensors							
	-00	-11	-13	-21	-23	-41	-43	-51
PH91 portable pH meter or PH92 Portable pH/ORP meter	✓	✓	✓	✓	✓	✓	✓	✓
Quick Manual and Safety Precautions (this manual)	✓	✓	✓	✓	✓	✓	✓	✓
Sensor(s) (pH or ORP sensor)	-	✓	✓	✓	✓	✓	✓	✓*
Cotton swabs for sensor cleaning (5pcs)	-	✓	✓	✓	✓	✓	✓	✓
pH 4 buffer solution (50 mL)	-	✓	✓	✓	✓	-	-	✓
pH 7 buffer solution (50 mL)	-	✓	✓	✓	✓	-	-	✓
Calibration bottles (10 mL, 2 pcs)	-	✓	✓	✓	✓	-	-	✓
3.3 mol/l KCl solution (50 mL)	-	-	-	✓	✓	✓	✓	✓
Syringe (6 mL)	-	-	-	✓	✓	✓	✓	✓

*: For PH92-51, two sensors are included, pH and ORP

1.3 Model and Suffix Codes

PH91 Portable pH meter

Model	Suffix code	Option code	Description
PH91	Portable pH meter
Connecting sensors	-00	Without sensor
	-11	With KCl replenish-free type combination pH sensor (cable length: 0.75 m)
	-13	With KCl replenish-free type combination pH sensor (cable length: 2.75 m)
	-21	With KCl replenish-free type combination pH sensor (cable length: 2.75 m)
	-23	With KCl refillable type combination pH sensor (cable length: 0.75 m)
Country *1	-J	Japan (with Japanese manual and batteries, without standard markings)
	-E	Except Japan (with English manual and standard markings, without batteries)

*1: Always specify "-J" for orders to Japan ("-E" is not acceptable).
Always select "-E" for orders destined for outside Japan ("-J" is not acceptable).

PH92 Portable pH/ORP meter

Model	Suffix code	Option code	Description
PH92	Portable pH/ORP meter
Connecting sensors	-00	Without sensor
	-11	With KCl replenish-free type combination pH sensor (cable length: 0.75 m)
	-13	With KCl replenish-free type combination pH sensor (cable length: 2.75 m)
	-21	With KCl replenish-free type combination pH sensor (cable length: 2.75 m)
	-23	With KCl refillable type combination pH sensor (cable length: 0.75 m)
	-41	With KCl refillable type combination pH sensor (cable length: 2.75 m)
	-43	With KCl refillable type combination pH sensor (cable length: 2.75 m)
	-51	With KCl refillable type ORP sensor (cable length: 0.75 m)
Country *1	-J	Japan (with Japanese manual and batteries, without standard markings)
	-E	Except Japan (with English manual and standard markings, without batteries)

*1: Always specify "-J" for orders to Japan ("-E" is not acceptable).
Always select "-E" for orders destined for outside Japan ("-J" is not acceptable).

PH92SN pH sensor for portable pH/ORP meter

Model	Suffix code	Option code	Description
PH92SN	pH sensor for portable pH/ORP meter
Type	-11	KCl replenish-free type combination pH sensor (cable length: 0.75 m)
	-13	KCl replenish-free type combination pH sensor (cable length: 2.75 m)
	-21	KCl replenish type combination pH sensor (cable length: 0.75 m)
	-23	KCl replenish type combination pH sensor (cable length: 2.75 m)
—	-AA	Always -AA

OR92SN ORP sensor for portable pH/ORP meter

Model	Suffix code	Option code	Description
OR92SN	ORP sensor for portable pH/ORP meter
Type	-41	KCl refillable type ORP sensor (cable length: 0.75 m)
	-43	KCl refillable type ORP sensor (cable length: 2.75 m)
—	-AA	Always -AA

1.4 Part Name and Functions

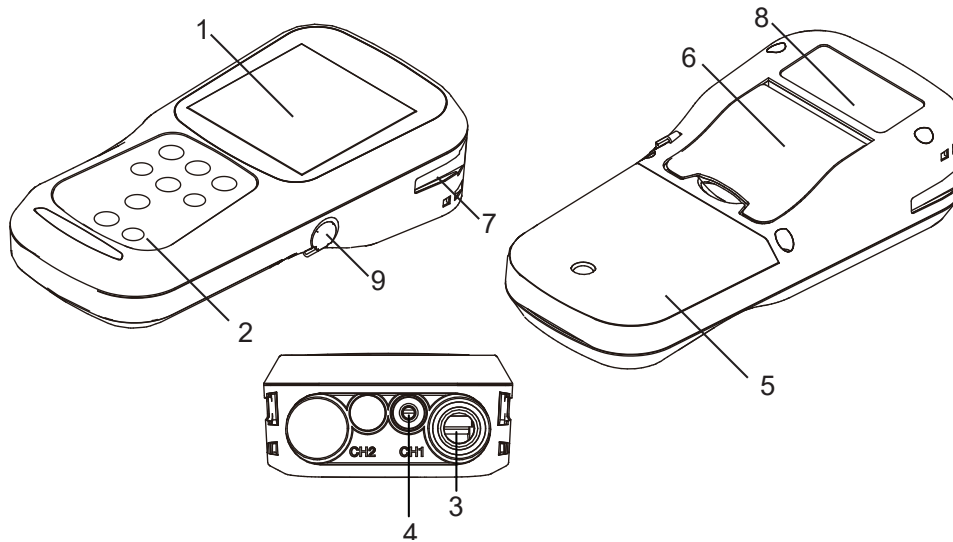

No	Name	Description
1	LCD	Displays the measured value
2	Operation keys	Used for instrument operation
3	Electrode connector	Connect electrode connector for pH/ORP sensor, temperature connector. CH1 is used.
4	Temperature connector	
5	Battery cover	Open/close to insert/remove batteries
6	Meter stand	Put up the stand to tilt the meter, when the LCD is difficult to see. Place the meter on a flat surface.
7	Sensor holder	Hook the sensor by sliding it into the holder from the top.
8	Name plate	—
9	—	Not used.

Figure 1.2 Name and functions of the meter

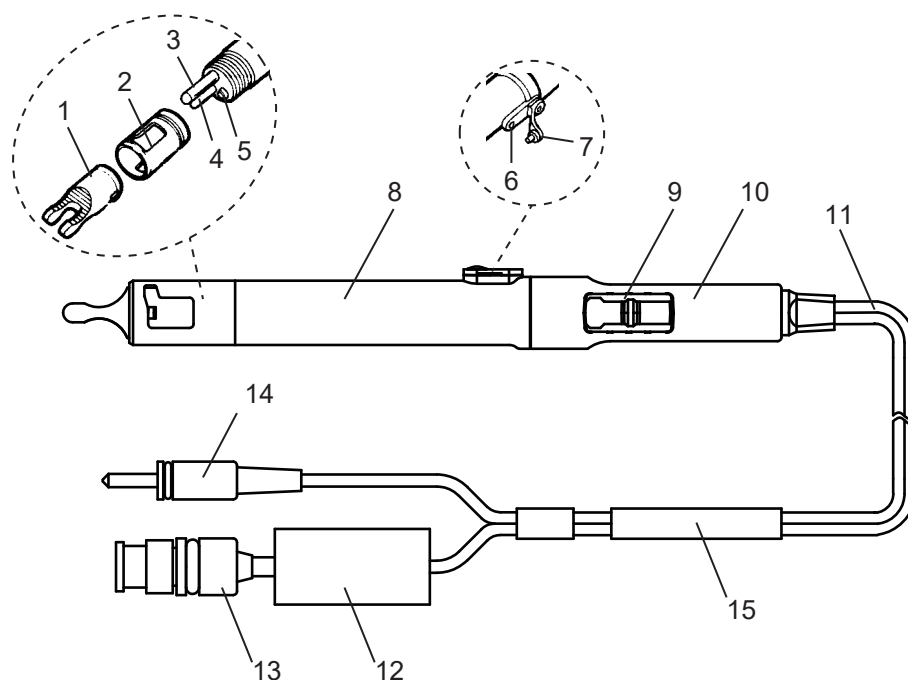

No	Name	Description
1	Wetting cap	To prevent the glass electrode from drying out, when storing the cap, place a piece of cotton soaked with water (KCl solution) inside the cap.
2	Protective cover	Remove only when cleaning.
3	Glass electrode (Platinum electrode)	Glass electrode: pH, Platinum electrode; ORP
4	Temperature element (Temperature sensor)	Measure solution temperature and compensate for the temperature of the pH electrode.
5	Liquid junction	Provide electrical contact between internal reference electrode and sample solution.
6	Filling port for KCl solution	Refill the sensor with the internal filling solution here. Use 3.3 mol/L KCl solution.
7	Filling port plug (*)	Only for KCl refillable type sensor. Prevent filling solution from leaking from filling port during storage. Always unplugged during measurement.
8	Sensor body	Thermal resistance 80°C plastic
9	Latch	To hold the sensor to the side of the meter. Insert the sensor into the latch from the top.
10	Sensor grip	Easy-to-hold grip
11	Sensor cable	—
12	Connector cover	—
13	Electrode Connector	Connects sensors to the meter.
14	Temperature connector	Connect sensors to the meter. Normally connect to the temperature connector and measure in automatic temperature compensation (ATC) mode, but disconnect in manual temperature compensation (MTC) mode.
15	Name plate	—

Figure 1.3 Name and functions of the sensor (The figure above is KCl refillable sensor)

■ Operation keys



Key	Name	Function
	CAL key	Switch from measurement mode to calibration mode CAL . Calibration start in calibration mode.
	MEAS key	Switch to measurement mode MEAS from others. In Auto Hold mode, the measurement value can be unfixed and a new measurement can start.
	DATA key	Switch from measurement mode to data mode DATA . Use the key to see the saved data.
	SET key	Switch from measurement mode to setting mode SET . When in a measurement mode, you will return to a previous setting. Make various settings.
	MODE key	Change the measurement parameters in a measurement mode. For PH92, switch between pH and ORP. This key does not work on PH91.
	ENT key	Select or set items. In a measurement mode, data can be saved. When the data logging interval is set, the logging of data storage starts. (DATA is displayed when data is saved)
	up	Move between various setting items in setting mode.
	down	Select items on the setting screen. Increase or decrease the number when entering numbers.
	power key	Switch the main unit power supply ON/OFF.

Figure 1.4 Key name and functions

■ Display items

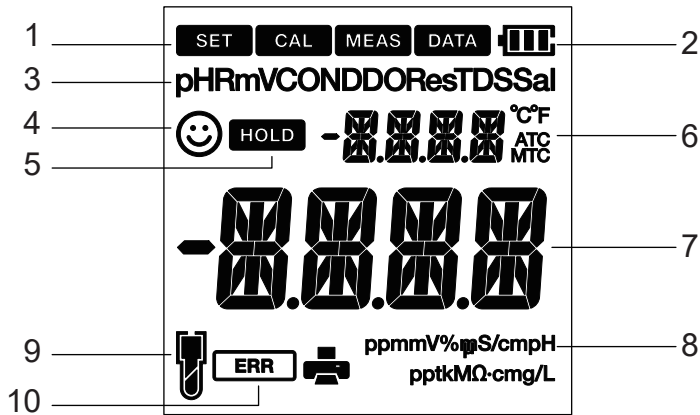



No	Function										
1	Current operation mode (Setup, Calibration, Measurement, Data mode)										
2	Battery level										
	<table border="1"> <thead> <tr> <th>Icon</th> <th>Battery level</th> </tr> </thead> <tbody> <tr> <td></td> <td>100%</td> </tr> <tr> <td></td> <td>50%</td> </tr> <tr> <td></td> <td>20%</td> </tr> <tr> <td></td> <td>Low battery. Need replacement.</td> </tr> </tbody> </table>	Icon	Battery level		100%		50%		20%		Low battery. Need replacement.
	Icon	Battery level									
		100%									
		50%									
	20%										
	Low battery. Need replacement.										
BATT LOW	See ■ Error messages .										
3	Measurement items such as pH and mV (ORP measurement)										
4	Show stability. Indicates that the value is stable and can be read in auto-stability and auto-hold modes.										
5	Indicates that the measured value display is stable and the measured value is fixed in auto hold mode.										
	Measured temperature and messages.										
6	When the temperature connector is unplugged, MTC, when plugged, ATC is displayed. (ATC: automatic, MTC: manual)										
7	Measured values, set values and messages.										
8	The units of the measurement parameter.										
9	The sensitivity level. It is not displayed if there is no calibration data.										
	<table border="1"> <thead> <tr> <th>Icon</th> <th>Average (Slope)</th> </tr> </thead> <tbody> <tr> <td></td> <td>SLPE: 95.0% to 105.0%</td> </tr> <tr> <td></td> <td>SLPE: 85.0% to 94.9%</td> </tr> <tr> <td></td> <td>SLPE: 80.0% to 84.9%</td> </tr> <tr> <td>SLPE ERR</td> <td>Low sensitivity (slope). See ■ Error messages to solve the problem.</td> </tr> </tbody> </table>	Icon	Average (Slope)		SLPE: 95.0% to 105.0%		SLPE: 85.0% to 94.9%		SLPE: 80.0% to 84.9%	SLPE ERR	Low sensitivity (slope). See ■ Error messages to solve the problem.
	Icon	Average (Slope)									
		SLPE: 95.0% to 105.0%									
		SLPE: 85.0% to 94.9%									
	SLPE: 80.0% to 84.9%										
SLPE ERR	Low sensitivity (slope). See ■ Error messages to solve the problem.										
10	Errors										

Figure 1.5 Display items (The figure above shows full screen display. Some are not displayed under normal use.)

The average sensitivity is the mean of the individual sensitivities (slope) calculated by the calibration. For example, if a 3-point calibration is performed and the sensitivity of the pH7 and pH4 standards is 96.0% and that of the pH7 and pH9 standards is 92.0%, the average sensitivity is 94.0%.

1.5 Optional Accessories

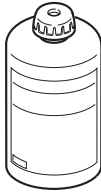
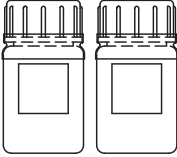
Optional accessories as shown below are sold separately if necessary.

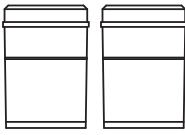
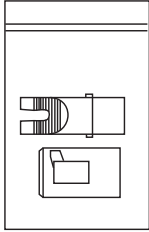
Name	Description	Part number	Quantity	
BUFFER	pH4 buffer solution 250mL	K9084KF*	1 pc	
	pH7 buffer solution 250mL	K9084KG*	1 pc	
	pH9 buffer solution 250mL	K9084KH*	1 pc	
KCl REAGENT	3.3 mol/L KCl solution 50mL	K9220XH*	2 pcs	
REAGENT AS	Quinhydrone reagent for ORP Check 250mL (only for PH92)	K9024EC*	3 pcs/set	
BOTTLE	Bottle assy 10mL (the same one supplied with the product)	K9220WW	2 pcs	
CAP SET	Cap and protective cover for sensor (Purchase when damaged or lost)	K9220ZY	1 set	

*: You can download the Safety Data Sheet (SDS) from the following website: <https://www.yokogawa.com/library/>

1.6 Dimensions

PH91, PH92 meter (when the back stand is up)

Unit: mm

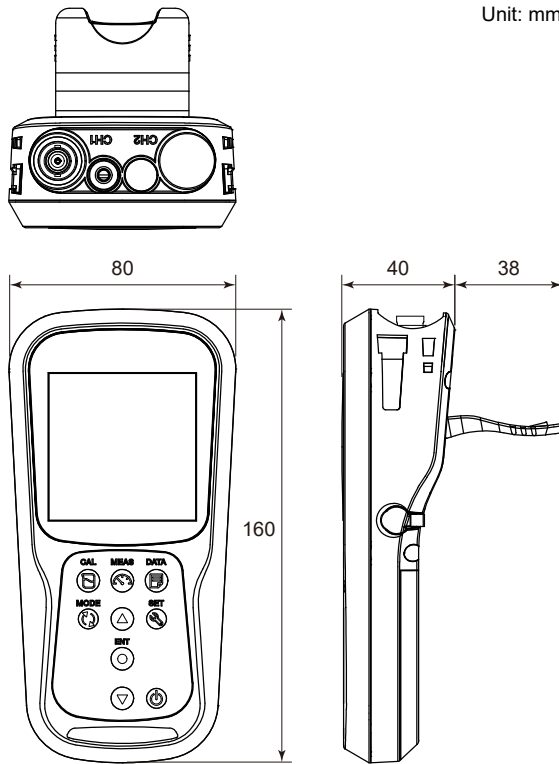

PH92SN pH sensor

KCl replenish-free type combination pH sensor

PH92SN-11-AA

PH92SN-13-AA Approx. 0.75 m or Approx. 2.75 m

KCl refillable type combination pH sensor

PH92SN-21-AA

PH92SN-23-AA Approx. 0.75 m or Approx. 2.75 m

Unit: mm

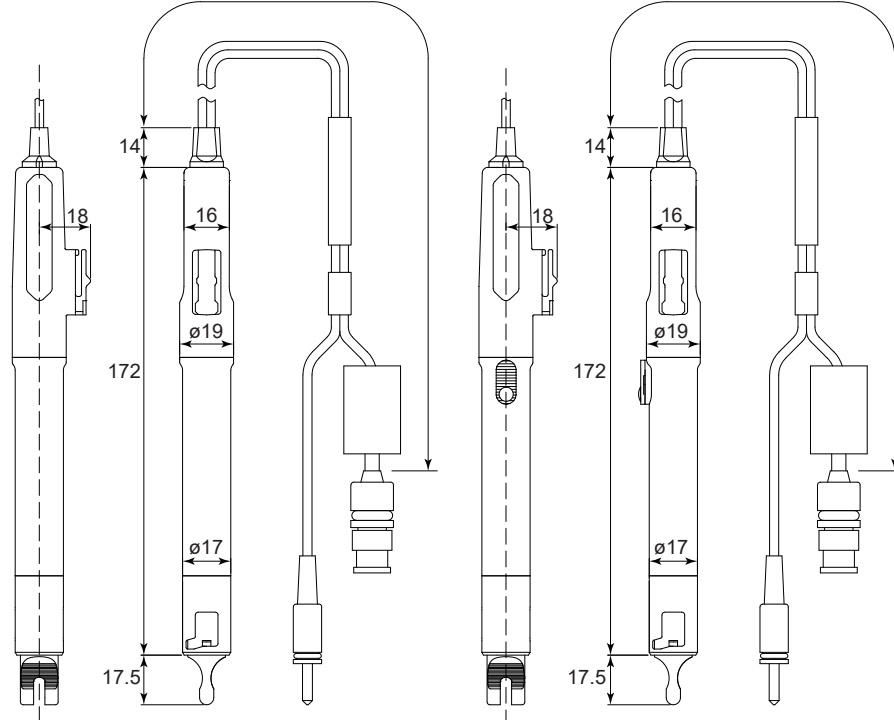

OR92SN ORP sensor

KCl refillable type ORP sensor Unit: mm

OR92SN-41-AA

OR92SN-43-AA Approx. 0.75 m or Approx. 2.75 m

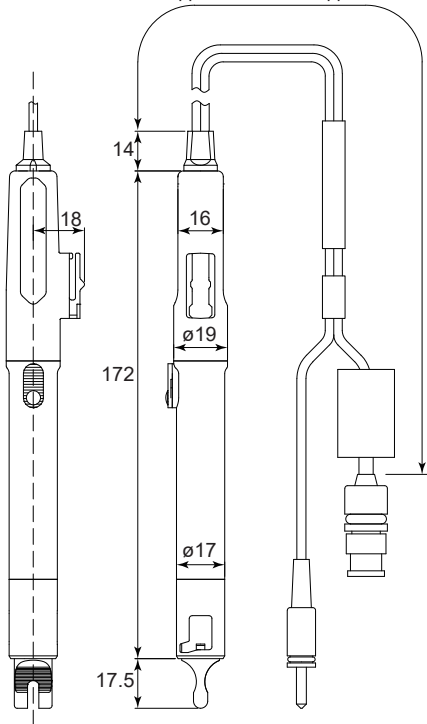

2. Basic Operations

Before use, put batteries in the meter and connect the sensor. Before starting a measurement (Chapter 3), set (Chapter 4) and calibrate (Chapter 5) to your preference as needed.

NOTE

Operate the keys with your fingers.

2.1 Inserting the Batteries

Put AA alkaline batteries into the meter.

- (1) Unscrew the battery cover on the back of the meter counter-clockwise to unlock the battery cover.
- (2) Remove the battery cover and set the batteries inside.
- (3) Put the cover back on.
- (4) Screw the battery cover on the back of the instrument clockwise to lock the battery cover.

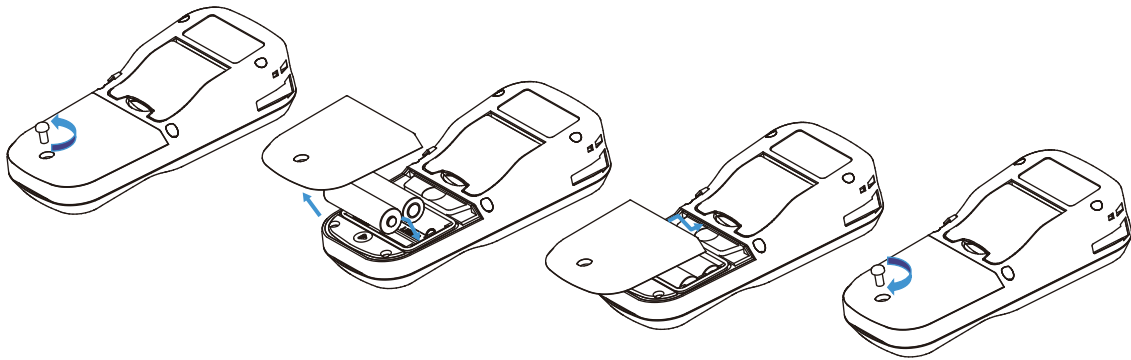



Figure 2.1 Insert battery into the meter

Power is turned on when batteries are inserted. To turn off the power, press and hold the power  key. To turn the power on again, press the power  key.



CAUTION

- When installing batteries, observe correct polarity: + (plus) - (minus). Failure to do so may damage to the meter.
- Do not use two different types of batteries or use new and old batteries at the same time.
- Do not replace the batteries in a dusty place or with wet hands. Dust or moisture could get inside the instrument and possibly cause an instrument malfunction.
- Prevent electrostatic damage when replacing batteries.
- Take care not to damage the gasket in the battery box to keep waterproof and dustproof.
- When a battery cover is replaced, make sure that the gasket is clean and correctly fitted in order to maintain the waterproof/dustproof.
- The screw for a battery cover shall be tightened with 1.2 N•m
- Loosen only the battery cover screws. Do not unscrew other screws to maintain waterproof and dustproof.

2.2 Connecting Sensor

Connect a pH or ORP sensor (PH92 only) to CH1.
The connectable sensors are PH92SN for pH sensor and OR92SN for ORP sensor.
It is no problem to connect the sensor while the power is ON.

Connect the sensor to the meter properly as follows.

- (1) Align the slot of the electrode connector with the pin of the electrode connector on the meter and insert it. After firmly pushing it all the way in, turn the electrode connector all the way to the right.
- (2) Slide the connector cover over the connector and push the cover straight down until it lightly touches the meter body. Do not turn the cover.
- (3) Insert the temperature connector into the temperature connector on the meter. Insert the temperature connector firmly until the O-ring on the temperature connector is no longer visible.

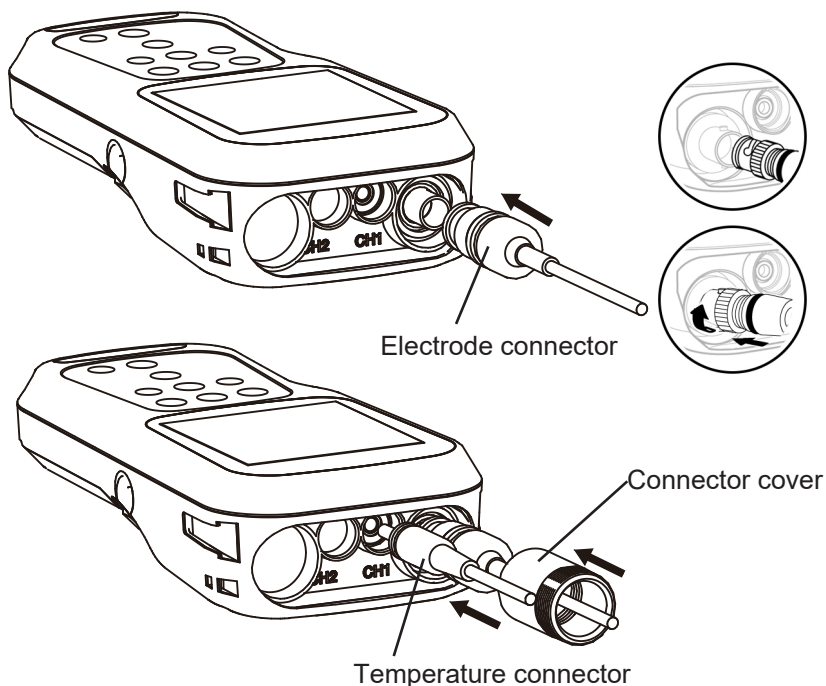

Figure 2.2 Connection with sensors



CAUTION

- Connect the sensor in a place free from moisture and dust.
- Take care not wet or contaminate the connector.
- When connecting sensors, be careful not to damage the equipment due to static electricity.
- To maintain waterproof and dustproof performance (IP67), use the cover and plug the connector properly.

Leave the sensor connected unless there is a particular need to disconnect it. When disconnecting the sensor, follow the reverse procedure of the connection. Never forcefully pull on the electrode connector. It is no problem to disconnect the sensor while the power is ON.

NOTE

- If the temperature connector is not plugged in, MTC is displayed; if it is, ATC is displayed. (page 3-3 ■ Temperature Compensation)
- IP67 is not guaranteed if the temperature connector is not plugged in.

● **How to change the measurement parameter (for only PH92)**

PH92 can measure both pH and ORP.

The factory default setting is pH measurement mode; when connecting an ORP sensor, be sure to change to ORP measurement mode with the MODE  key before measurement.



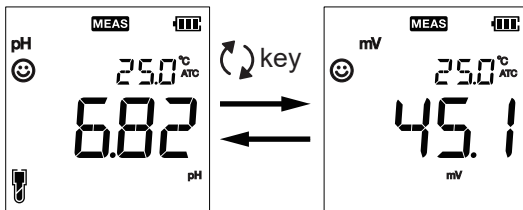





When in measurement mode, press Mode the MODE  key to switch measurement parameters.



When using both a pH sensor and an ORP sensor with the PH92, make sure that the upper left display shows the correct pH or mV (or RmV) for the connected sensor before measuring.

2.3 Changing Operation Mode

You can change the operation mode to four available modes depending on the purpose of use. The status icon indicates the current mode.

Icon	Name	Function	Chapter
	Setup mode	Perform various setup Press the SET  key in the measurement mode to go to the setup mode. Press the SET  key in the setup mode to return to the previous screen.	4
	Calibration mode	Perform calibration. Press the CAL  key in the measurement mode to go to the calibration mode.	5
	Measurement mode	Perform measurement. Press the MEAS  key outside of the measurement mode to go to the measurement mode.	3
	Data mode	Display the saved data. Press the DATA  key in the measurement mode to go to the data mode.	6

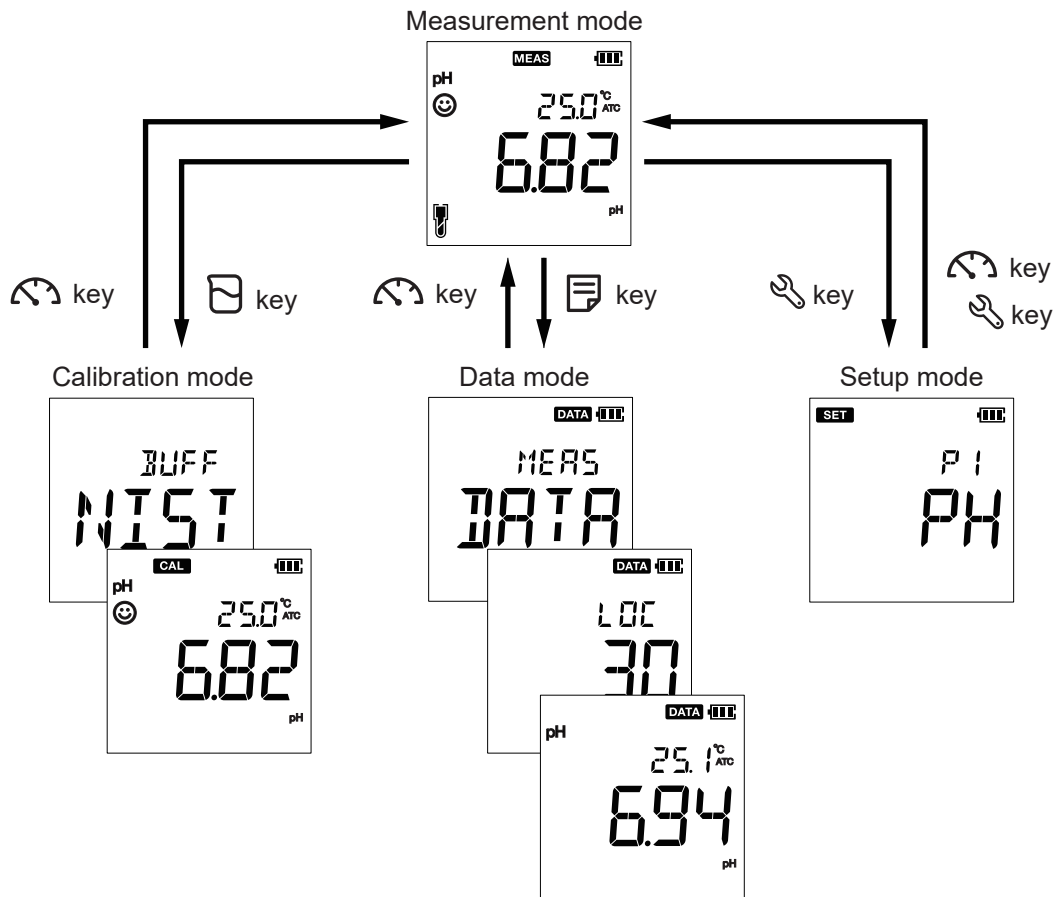

2.4 Saving Data

In a measurement mode, press the ENT ● key. **DATA** appears and the displayed data are saved. The measurement item, temperature, and measured value data are saved. The data number (LOC: location number) is displayed, then automatically returns to the previous screen.

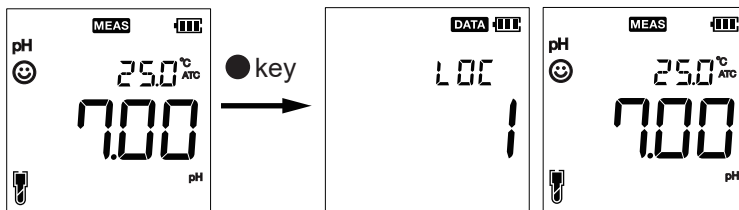

The data log function allows you to automatically save data at set time intervals. Press the ENT ● key to start/stop. (4.2.1 Data log interval setup (LOG))

NOTE

When the data storage limit (500 data) is reached, you cannot store data, an error occurs, MEM FULL :memory is full, is displayed. If you want to save new data, delete the stored data. (4.2.2 Erase all saved data (D.CLr))

3. Measurement Mode (MEAS)

This mode performs measurements and **MEAS** is indicated on the screen.

If you are in any other mode, press the MEAS  key to switch to measurement mode.

While in measurement mode, press the MODE  key to switch to ORP measurement (PH92 only).

In Auto Hold mode, press MEAS  key during measurement mode to cancel HOLD **HOLD**.

■ Precautions

- If the instrument has been stored for a long period of time, make sure that the calibration is correct by measuring the standard solution. If the instrument has been stored for a long period of time, it is recommended that it be calibrated before use.
- If you use a KCl refillable type sensor, check the amount of filling solution. (Section 7.3.2)
- Do not use for measurement of solutions exceeding 80°C (50°C or lower when using KCl replenish-free type sensor and being submerged above the grip section).
Do not use for measurement of highly corrosive solutions, such as solutions containing hydrofluoric acid (hydrofluoric acid).
- Wipe off any contaminant on the body with a soft cloth. If the contamination is severe, use a neutral detergent.
- See 8. Trouble Shooting to find the cause of trouble, if an abnormal phenomenon occurs during measurement.
- After the measurement is finished, wash off any contaminant or measurement solution adhering to the sensor with water and store it. (Section 7.3.1)

NOTE

For ORP measurements

- Measurement of solutions with extremely low concentrations of oxidants and reductants, such as press water, well water, and purified water, generally results in slightly poor reproducibility or response.
- Alkaline ionized water should be measured promptly, as the value can change significantly if left unattended.



CAUTION

- The meter is made of solvent resistant materials but is not resistant to all chemicals. Do not immerse the instrument in strong acid or alkali solution, or wipe it with such solutions.
- When using a KCl refillable type sensor, the filling solution level must be above the level of solution being measured. This prevents the KCl filling solution from being mixed with the sample solution.

NOTE

- Do not lose the sensor cap. Caps are available as Optional Accessories. (Section 1.5)
- The cap contains water-soaked cotton to keep the glass electrode from drying out. Be careful not to splash water when removing the cap.

How to measure

- (1) Remove the cap of sensor. Make sure there are no air bubbles in the electrode tip. Trapped bubbles may interfere with accurate measurement. If you see bubbles at the tip, gently shake the sensor as shown in Figure 3.1 to move the bubbles upward before starting the measurement.

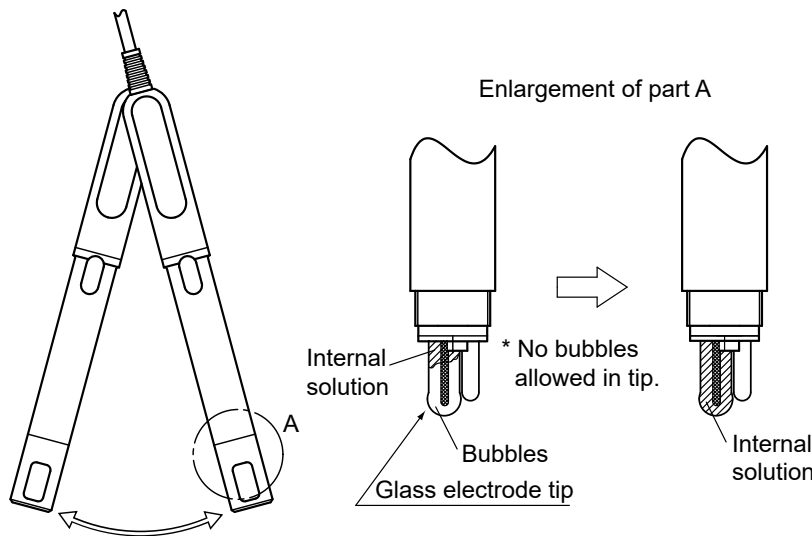
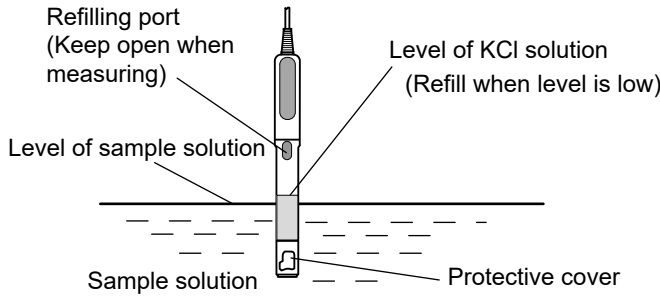

Figure 3.1 How to move air bubbles on the glass electrode tip

- (2) Immerse the sensor so that the protective cover part goes under the sample solution level. The sensor does not need to be immersed deeply. When using a KCl refillable type sensor, the filling solution level must be above the level of solution being measured. This prevents the KCl filling solution from being mixed with the sample solution.



For KCl refillable type sensor, the KCl solution level must be above the measured-solution level.

Figure 3.2 How to immerse sensor (when using KCl refillable type sensor)

- (3) In the Auto stable mode (default value), the stability evaluation starts automatically and 😊 blinks. After the reading becomes stable, 😊 will change from blinking to steady-on and the stable measurement value is shown.

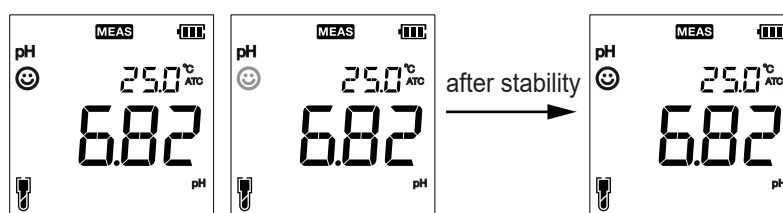

Figure 3.3 Example of pH measurement (auto stability mode)

■ Temperature Compensation

There are two types of temperature compensation: automatic temperature compensation (ATC) and manual temperature compensation (MTC).

Automatic temperature compensation (ATC) measures the temperature of the solution and automatically compensates for it by connecting the temperature sensor (temperature connector) built into the sensor to the meter.

The instrument normally uses a temperature sensor built into the sensor to measure the temperature of the solution for automatic temperature compensation (ATC), but manual temperature compensation (MTC) is also possible using a solution of known temperature. When the temperature connector is disconnected, manual temperature compensation (MTC) is automatically activated.

Manual temperature compensation (MTC) is performed by measuring the temperature of the solution in advance and manually entering the temperature value without connecting a temperature sensor (temperature connector) to the meter.

To manually input the temperature of the solution measured in advance, follow the same procedure as (2) to (6) in “5.3 Temperature Calibration”. Be sure to disconnect the temperature connector, and in (4), input the temperature you wish to set instead of the temperature to be calibrated. It is not necessary to immerse the detector in the solution.

■ Display of absolute and relative measurements

Although two types of ORP measurement are available, absolute and relative, measurements should normally be performed using the absolute value display.

Check the soundness of the product with the check solution, and if it is normal, use the product for measurement. (7.3.4 Check oxidation-reduction potential)

Absolute value measurement displays the absolute value of oxidation-reduction potential.

Absolute value measurement (mV display) is factory set.

Relative measurements are displayed after applying a certain correction to the absolute value. In this case, the relative value is displayed as RmV. The correction can be set in the range of ± 200 mV relative to the absolute value displayed.

To measure relative values, setting a correction value must be set from the calibration mode. See 5.2 Relative Value (RmV) Display of ORP.

To cancel relative value measurement, perform “4.1.3 Erase calibration data (C.CLr)”.

4. Setup Mode (SET)

Set up various settings. Press the SET  key to go to the setup mode. **SET** is displayed.

NOTE

Press the MEAS  key to return to measurement mode after setting.

In the setup mode (**SET** is displayed), press the SET  key to return to the previous screen.







4.1 pH Setup (PH)

Using pH setup function of the meter, you can:

- Select pH buffer standard
- Set calibration interval alarm
- Erase calibration data

4.1.1 pH Buffer Standard (BUFF)

Select the buffer standard for the pH standard solution out of NIST (default), USA, and DIN.

- (1) Press the SET  key.
- (2) When P1 PH screen appears, press the ENT  key.
- (3) When P1.1 BUFF screen appears, press the ENT  key.
- (4) Use   to change the buffer standard. Select one and press the ENT  key. P1.1 BUFF screen appears.

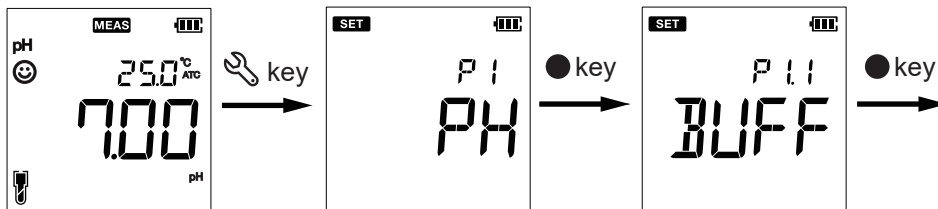

Select the buffer standard

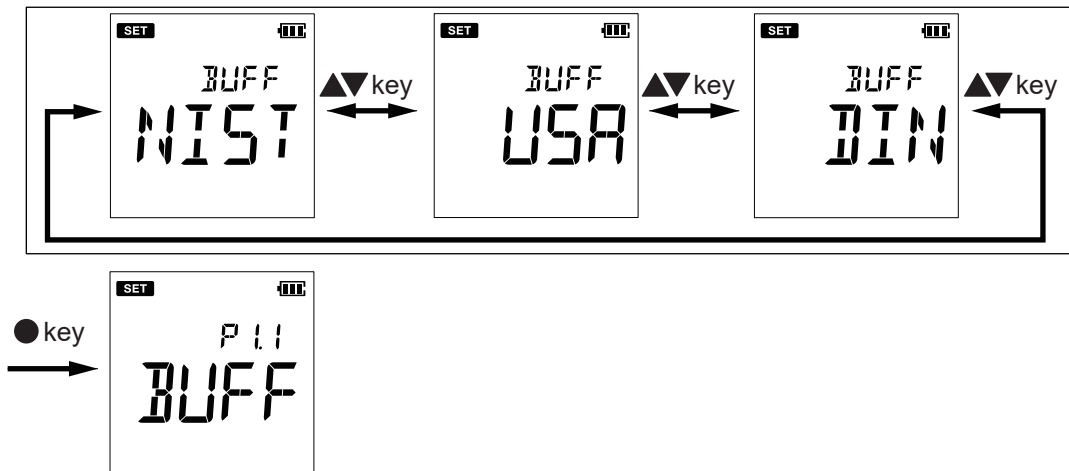

Table 4.1 pH at 25°C for each standard

NIST	1.68	—	4.01	6.86	9.18	12.45
USA	1.68	—	4.01	7.00	10.01	12.45
DIN	1.09	3.06	4.65	6.79	9.23	12.75







NIST and USA standard buffer solution can perform up to 5-point calibration, and DIN can up to 6-point calibration. We do not provide USA and DIN standard pH buffer solutions, so the user must provide.

4.1.2 Calibration interval alarm setup (C. ALr)

Set the calibration interval days so that an alarm is triggered when the calibration has not been performed for a long period of time.

An alarm  will blink when the predetermined number of days has elapsed.





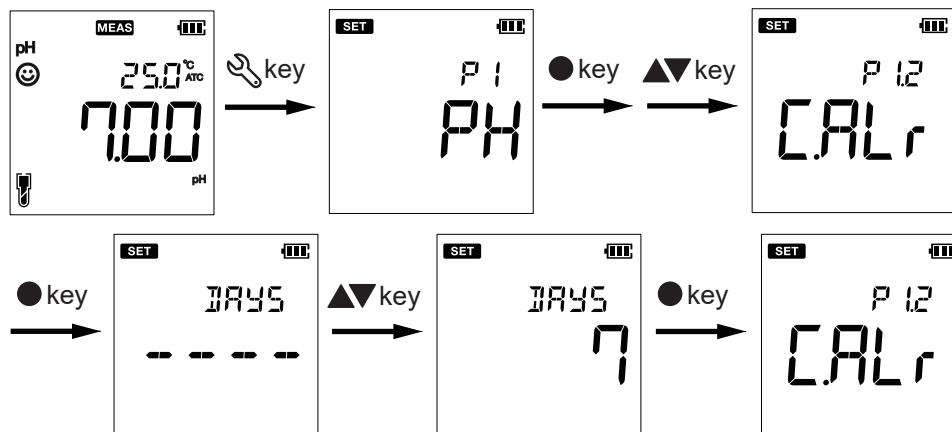

1 to 90 days can be set. The initial value is “----” (no calibration interval alarm is set).

- (1) Press the SET  key.
- (2) When the P1 PH screen appears, press the ENT  key.
- (3) When the P1.1 BUFF screen appears, press the up  key once to go to the P1.2 C.ALr screen and press the ENT  key.
- (4) Set the number of calibration interval before the next calibration date by pressing  , and press the ENT  key to confirm. P1.2 C.ALr screen appears.



4.1.3 Erase calibration data (C.CLr)

Erase pH calibration data.

- (1) Press the SET  key.
- (2) When the P1 PH screen appears, press the ENT  key.
- (3) When the P1.1 BUFF screen appears, press the up  key two times to go to the P1.3 C.CLr screen and press the ENT  key.
- (4) A confirmation screen for erasing calibration data (C.CLr) appears. If you want to erase the data, press   to YES and press the ENT  key. DONE is displayed and the P1.3 C.CLr screen appears immediately.

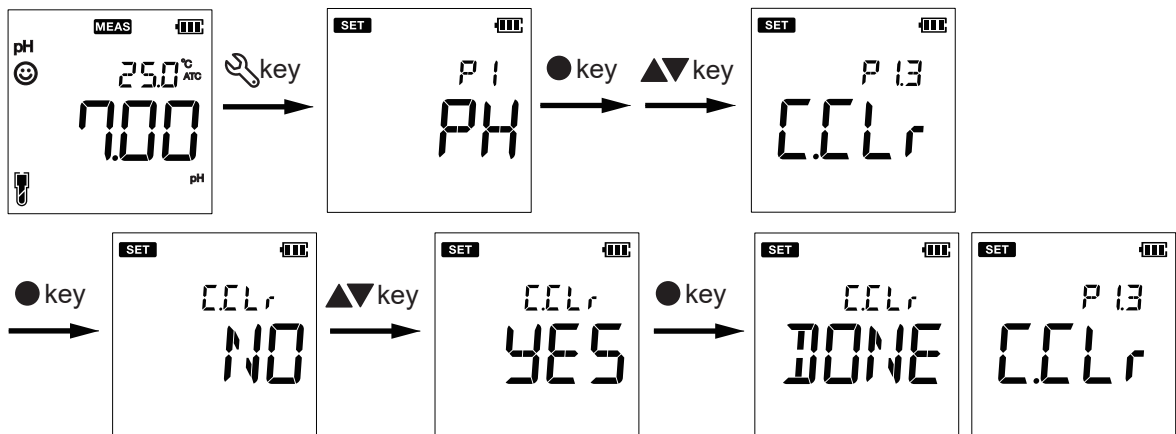

NOTE

Note that when relative value measurement of ORP is being performed by PH92, deleting the calibration data will cancel the relative value measurement. See Page 3-3 ■ Display of absolute and relative measurements.

4.2 Data Setup (DATA)

Using Data setup function of the meter, you can:







- Set data log interval
- Erase all stored data

4.2.1 Data log interval setup (LOG)

The Data Log function allows you to automatically save data at time intervals set here. You can set the time interval from 2 to 999 seconds. The default value is “----” (no data logging interval is set).

NOTE

If the data logging interval is set to a value other than “----”, auto power off (4.3.2 Auto power-off (A.Off)) is disabled. Power of the unit will remain on until the switch is turned off. Be aware of battery consumption.

- (1) Press the SET .key.
- (2) When the P1 PH screen appears, press the up  key once to go to the P2 DATA screen and press the ENT  key.
- (3) When the P2.1 LOG screen appears, press the ENT  key.
- (4) Press  to display the data log interval and press the ENT  key to confirm. The P2.1 LOG screen appears.

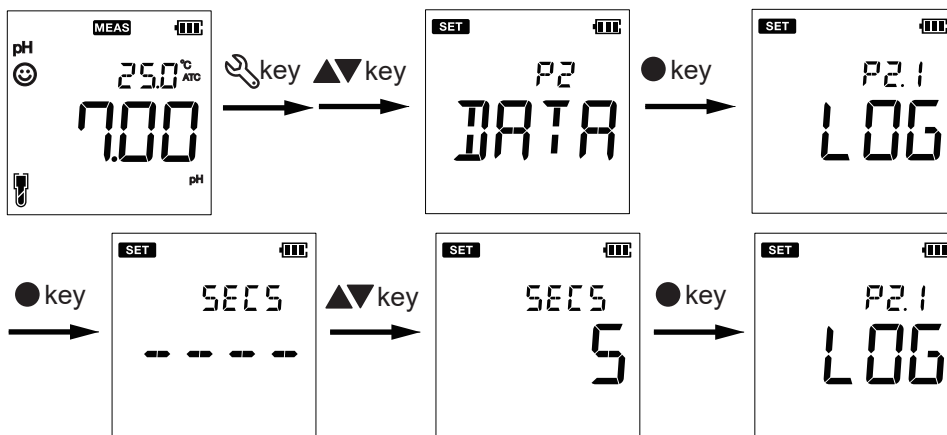







NOTE

Press the ENT  key.in measurement mode to start the first data log.(**DATA** blinks) Press again to stop.

4.2.2 Erase all saved data (D.CLR)

Erase all stored data.

- (1) Press the SET  key.
- (2) When the P1 PH screen appears, press the up  key once to go to P2 DATA screen and press the ENT  key.
- (3) When the P2.1 LOG screen appears, press the up  key once to go to the P2.2 D.CLR screen, and then press the ENT  key.
- (4) When the confirmation screen for deleting all stored data (D.CLR) appears, if you want to delete the data, press  to go to the YES screen and press the ENT  key. DONE is displayed and the P2.2 D.CLR screen appears immediately.

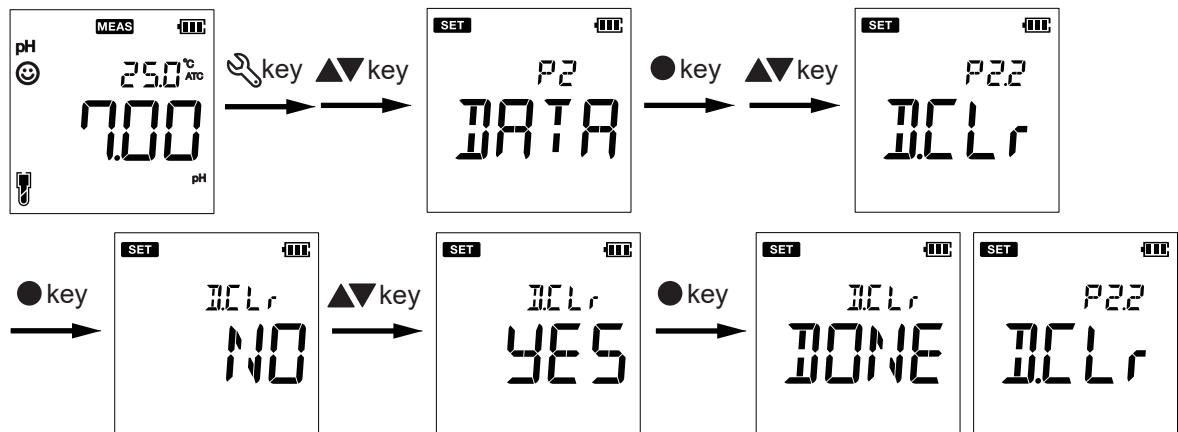

4.3 General Setup (GEN)







Using the general setup function of the meter, you can:

- Select stability check mode
- Set auto power-off time
- Reset the meter

4.3.1 Stability check (STBL)

Set auto stable mode, auto hold mode, and real time mode for stability evaluation.

Mode	State
AS (Auto Stable)	When the measured value meets the stability criteria, the ☺ will change from blinking to lit and the measured value will be fixed. If the value falls outside the stability criteria, the ☺ will blink again.
AH (Auto Hold)	The measured value is fixed at the point of stability and is displayed until the hold is released. ☺ will blink until the measured value stabilizes, then HOLD and ☺ will light up. To cancel HOLD , press the MEAS  key. When the value become stabilized again, HOLD will be displayed. HOLD can also be cancelled if you proceed from the measurement mode to other modes such as the setting mode.
RT (Real Time)	Measured values are displayed in real time. Not perform stability check.

- (1) Press the SET  key.
- (2) When the P1 PH screen appears, press the up  key twice to go to the P3 GEN screen and press the ENT  key.
- (3) When the P3.1 STBL screen appears, press the ENT  key.
- (4) Press  to display AS (Auto Stable), AH (Auto Hold) or RT (Real Time) and press the ENT  key to confirm. P3.1 STBL screen appears.

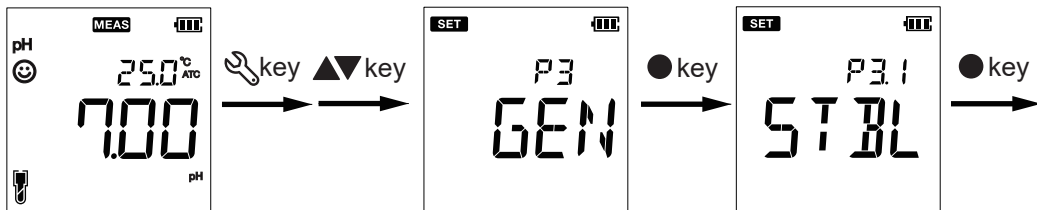

Select the Mode

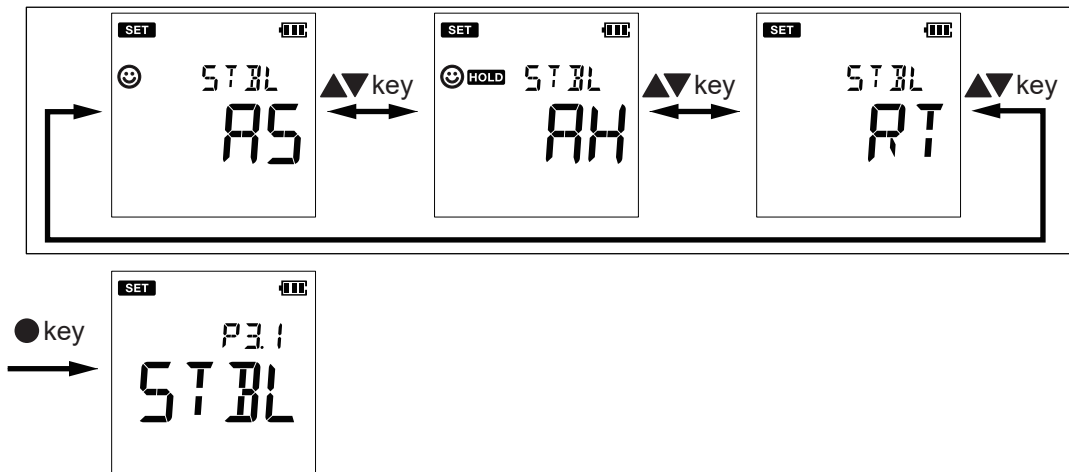

NOTE

The criteria for judging stability during Auto stable and Auto hold are as follows.

pH measurement: Change in pH measurement value during the 10-second period is within ± 0.015

ORP measurement: Potential change during the 10-second period is within 0.1 mV (measured value less than 1000 mV) or 1 mV (measured value greater than 1000 mV)

4.3.2 Auto power-off (A.Off)







Set the time to automatically turn off the power (auto power off) when no key operation is performed for a certain period of time.

The time can be set from 1 to 30 minutes. The initial value is 30 minutes.

Setting “----” disables the auto power off function, but the power of the unit will remain on until the switch is turned off. Be aware of battery consumption.

NOTE

- If the data logging interval (Section 4.2.1) is set to a value other than “----”, auto power off is disabled.
- When the data storage limit (500 data items) is reached, the data logging function automatically stops and the auto power off function is enabled.



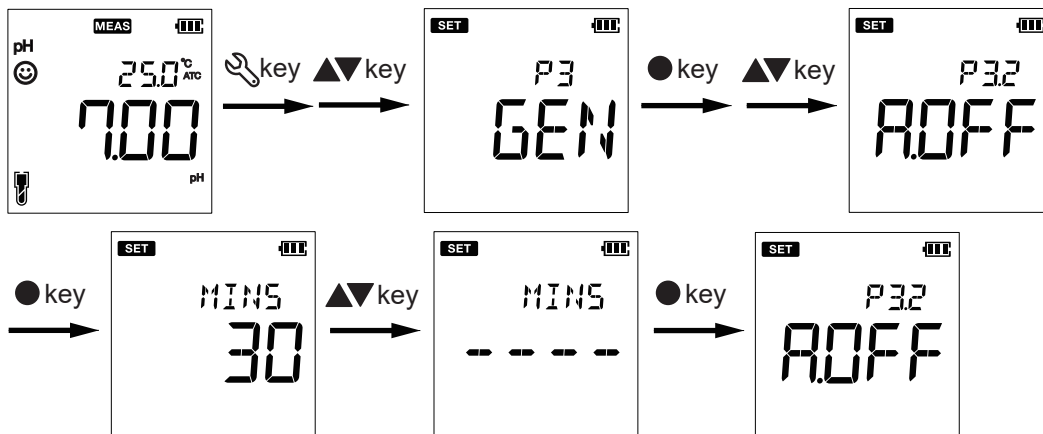





- (1) Press the SET  key.
- (2) When the P1 PH screen appears, press the up  key twice to go to the P3 GEN screen and press the ENT  key.
- (3) When the P3.1 STBL screen appears, press the key, then the P3.2 A.OFF screen appears. Press the ENT  key.
- (4) Press  to display the auto shut-off time and press the ENT  key to confirm. P3.2 A.OFF screen is displayed.



4.3.3 Reset the meter (r.SET)

Reset to factory default settings.

The power is automatically turned off after the resetting.

- (1) Press the SET  key.
- (2) When the P1 PH screen appears, press the up  key twice to go to the P3 GEN screen and press the ENT  key.
- (3) When the P3.1 STBL screen appears, press the up  key twice to go to the P3.3 r.SET screen and press the ENT  key.
- (4) When the reset (RSET) confirmation screen appears, if you want to reset, press   to go to the YES screen and press the ENT  key. DONE is displayed and the power turns off automatically.

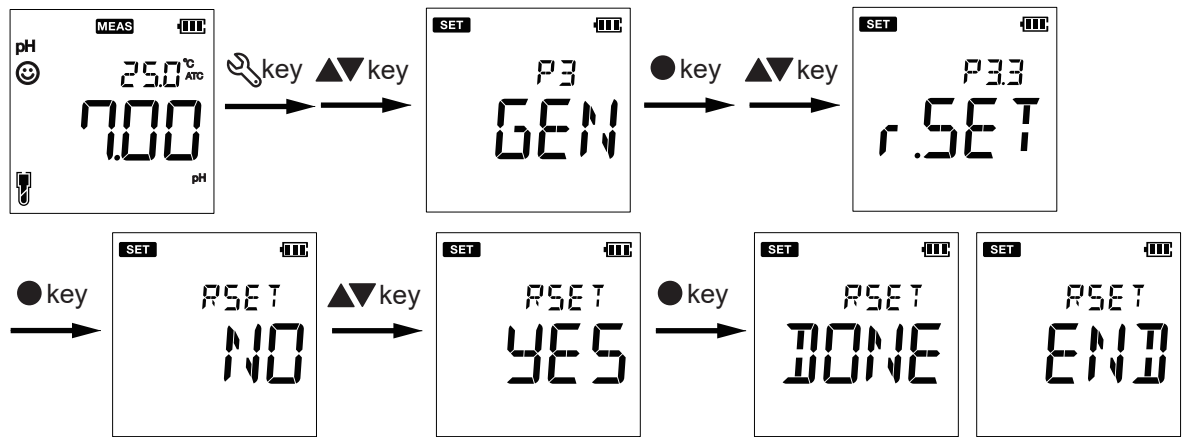

5. Calibration Mode (CAL)

In the calibration mode, Auto Stable mode (AS) is activated. The default setting for the stability check mode of the measurement mode is Auto Stable (AS), but you can change to “Auto Hold” (AH) or “Real Time” (RT). See 4.3.1 Stability check (STBL).

NOTE

Press the MEAS  key during the Calibration mode (**CAL** on display) to suspend the calibration in progress.

5.1 pH Calibration

Calibration is necessary for accurate pH measurement.

In particular, always perform calibration before use in the following cases.

- when the sensor is connected for the first time
- after the sensor is replaced
- after the meter has been stored for a long period
- after the electrode is cleaned

Otherwise, perform pH calibration when necessary, following the procedure below.

● How to prepare for calibration

Prepare the buffer solution required for calibration.

Perform a two-point calibration using the following. pH buffer solution is provided as optional accessories (see section 1.5).

For general two-point calibration, the following standard solutions are recommended.

- pH7 and pH4 standards for acidic samples
- pH7 and pH9 standards for alkaline samples

NOTE

- You must always start calibration from pH7. If you calibrate with the pH4 standard first, the asymmetric potential (zero) will be calculated based on the pH4 standard.
- The default standard is NIST; if you wish to change to USA or DIN, see 4.1.1 pH Buffer Standard (BUFF).
- It is recommended to erase the previous calibration data before calibration.

The following calculations are performed on the calibration data.

Suppose a two-point calibration is performed using a buffer solution 1 (pH7 standard) and a buffer solution 2. If calibration is performed with the buffer solution 1 with no calibration data, the asymmetric potential (zero) is saved. If calibration is performed again with the buffer solution 1, the asymmetric potential (zero) is updated. When calibrated with the buffer solution 2, the sensitivity (slope) is saved. Thereafter, the asymmetric potential (zero) will not be updated even after calibration with the buffer solution 1.





For this reason, when performing a new calibration, erase the calibration data before calibration. See 4.1.3 Erase calibration data (C.Clr) for how to erase calibration data.

Similarly in the case of 3-point calibration, etc., once the sensitivity (slope) is saved, only the sensitivity (slope) will be updated no matter which buffer solution is used for calibration.

NOTE

Note that if the PH92 is performing relative value measurement of ORP, the relative value measurement will be canceled once the calibration data is erased.

● How to perform pH calibration

- See page 3-2 ■ How to measure for information on sensor immersion depth and how to move bubbles.
 - For KCl refillable combination type pH sensor, open the refilling port.
1. After immersing the pH sensor in the buffer solution, press the CAL  key.
 2. The standard (NIST, USA, DIN) of the buffer solution being set is displayed, , and the stability assessment of the measured value begins.
 3. Wait until the value stabilizes:  goes from blinking to lit.
 4. Press the ENT  key to confirm and save calibration data.
 5. Meter displays DONE indicating end of the calibration procedure.
 6. When calibrating two or more points, repeat steps 1 through 5 above as necessary.

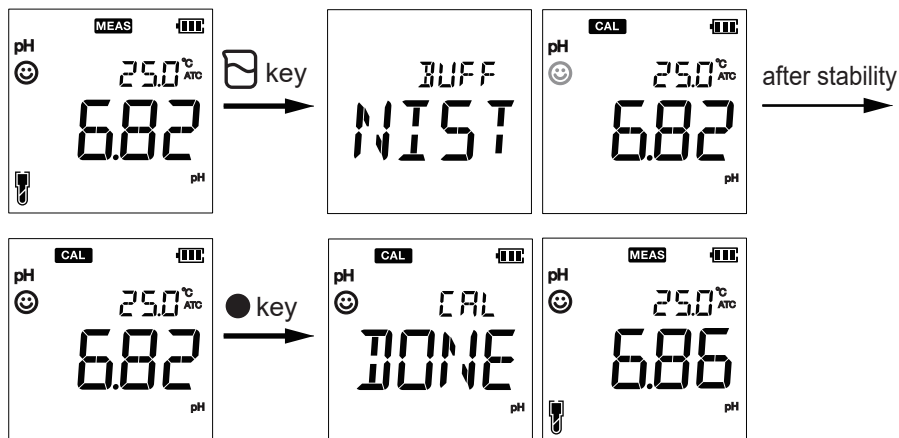

To check the calibration data, see 6. Data Mode (DATA).

5.2 Relative Value (RmV) Display of ORP

Only applicable when measuring ORP with PH92.

It is performed in calibration (CAL) mode, but it is not calibration.

In ORP measurement, two types of measurements are available: absolute and relative. (page 3-3 ■ Display of absolute and relative measurements)





To measure relative values, a correction value must be set from the calibration mode.

To cancel relative value measurement, perform "4.1.3 Erase calibration data (C.CLR)".

NOTE

If you erase the calibration data in an attempt to cancel the relative value measurement, the pH calibration data will be erased. Be careful when using the pH sensor.



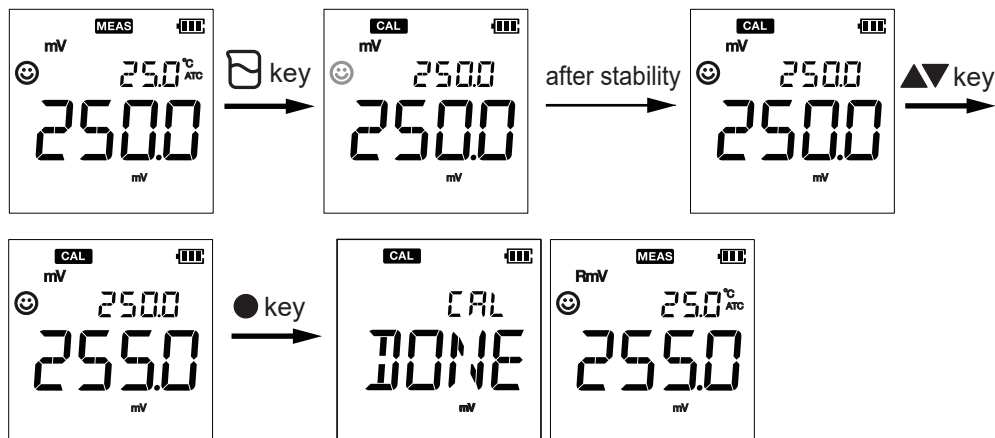

● How to set relative value (RmV) display

- Make sure you are in ORP measurement mode.
 - Open the refilling port of the ORP sensor.
 - See page 3-2 ■ How to measure for the immersion depth of the sensor and how to move the bubbles.
 - To set the relative value display, the redox potential of the sample solution must be stable. (4.3.1 Stability check (STBL))
1. Place the ORP sensor in the sample solution, then press the CAL  key.
 2. Start measuring the mV value,  keeps blinking on the screen, starting the value stability check.
 3. Wait until the value stabilizes ( changes from blinking to lit up).
 4. Adjust the current absolute mV value to the relative mV value you want to display by pressing .
 5. Press the ENTER  key to confirm and save the adjusted data.
 6. DONE is displayed and the conversion to relative ORP measurement is completed. The display changes to show RmV.



5.3 Temperature Calibration

Temperature calibration can be performed in automatic temperature compensation (ATC) mode. The sensor to be calibrated is immersed in temperature-controlled water in a thermostatic bath, and the sensor's temperature is adjusted to a reading of a reliable thermometer. Always perform this calibration with the temperature connector connected.

1. Immerse the pH sensor in the solution. Wait for 5 minutes until the temperature stabilizes.
2. Press the CAL  key to enter the calibration mode.
3. Press the MODE  key to display CAL TEMP and switch to temperature calibration mode. The current temperature is displayed on the upper line of the screen.
4. Press  to adjust the temperature shown in the lower part of the screen to the temperature to be calibrated.
5. Press the ENT  key to confirm.
6. DONE is displayed to indicate that the procedure has been completed.

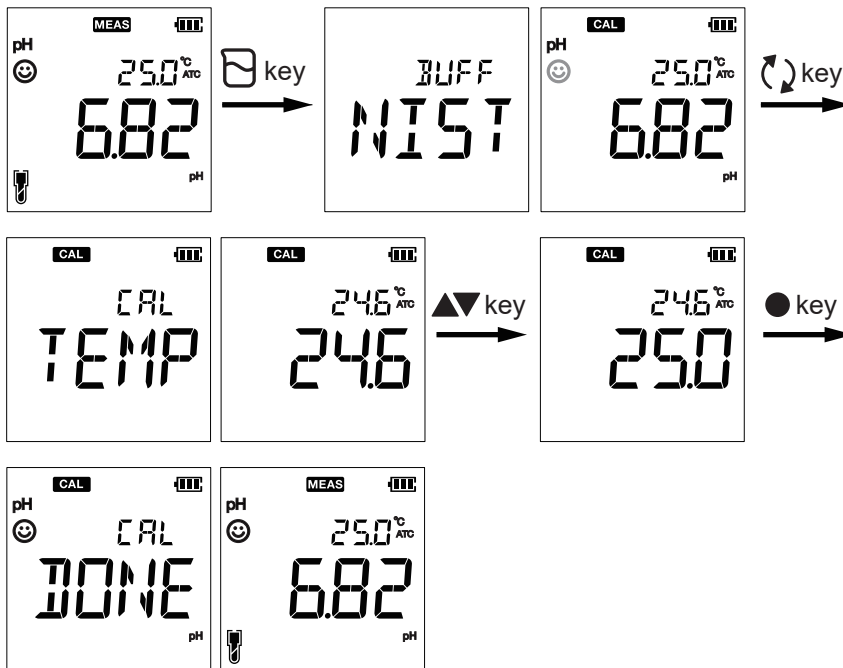

In the manual temperature compensation (MTC) mode, you can manually enter the pre-measured temperature of a solution using the above procedure. (page 3-3 ■ Temperature Compensation).

6. Data Mode (DATA)

In the data mode, you can check the data (measurement data and pH calibration data) stored in the internal memory.



See 2.4 Saving Data on how to save measurement data.

■ How to check saved data

Press the MEAS  key to return to the measurement mode.

● Measurement data

Press the DATA  during a measurement mode to display the saved data. You can check the data in order of data number (LOC: Location number).

The figure below shows that the latest stored data (LOC5) is displayed first. Press the down  key to see the previous data (LOC4). Press the up  key to see the oldest data (LOC1).

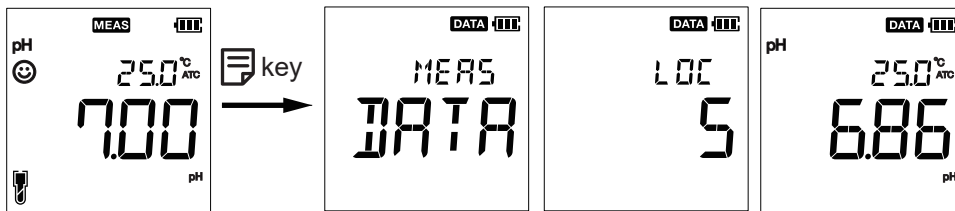

Figure 6.1 Confirmation on measurement data

● pH calibration data

Press the DATA  key during a calibration mode to check the pH calibration data.

The calibration value display switches, showing the number of calibration points, calibration point*, asymmetry potential (ZERO), and average sensitivity (SLOPE). After that, it returns to the screen before pressing the DATA.

*: Calibration points are displayed in ascending order of pH value from low to high.

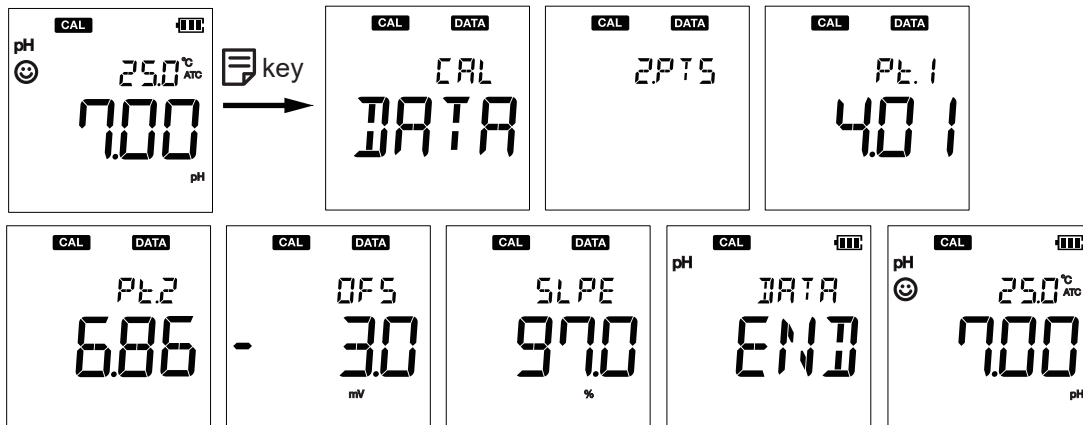

Figure 6.2 Confirmation on calibration data (example for 2 calibration points)

When no calibration data is stored, NO_CAL appears on display.

7. Storage and Maintenance

This section describes storage and maintenance of the meter and pH/ ORP sensors.



CAUTION

- Do not leave expired batteries in the meter. The batteries may leak and cause the instrument to fail or not operate properly.
- Remove the batteries when storing the instrument unused for an extended period of time.
- Do NOT leave the instrument in direct sunlight or in a hot and humid place such as inside a car for a long period of time.

7.1 Storage

■ Storage location

Select a location where the ambient temperature and humidity are within the following equipment specifications.

Temperature: 0 to +45 °C

Humidity: under 80% relative humidity and free from condensation

Avoid the following conditions.

- Dusty area
- Strong vibration
- Direct sunlight
- Corrosive gas environment
- Locations close to an air-conditioner
- Direct wind

■ How to store

Improper storage may cause malfunction. Store with the following precautions.

- Do not leave the sensor with the sample solution stained on it. Wash off the sample solution before storing it. If there are solid components adhering to the liquid junction in particular, remove them well. If the sensor is stored without being properly cleaned, the liquid junction may become clogged, resulting in unstable pH values during measurement and hampering accurate measurement.
- Always leave the sensor cap on. Put a few drops of water (3.3 mol/L KCl solution in the shipment) on the cotton inside the cap, and then install that cap.
- KCl-refillable type sensors need to seal the fill hole with a plug.
- Keep the sensor connected to the meter as much as possible. This will prevent the degradation of insulation resistance at the connector and prevent contamination of the O-ring for water proofing.
- Do not place any objects on the sensor as well as the meter itself.

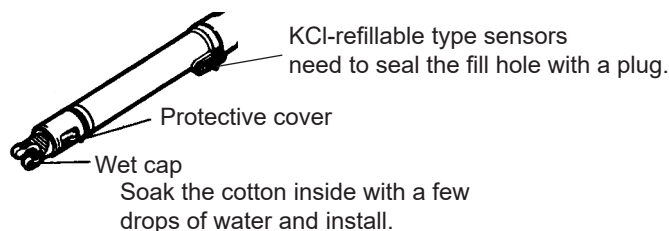

Figure 7.1 Storing sensors

7.2 Meter Maintenance

■ How to clean the meter

- Wipe off any contaminant on the body with a soft cloth. If the contamination is severe, use a neutral detergent.
- Although the body is made of solvent-resistant materials, it is not resistant to all chemicals. Do not immerse the instrument in solutions of strong acids, strong alkalis, etc., or wipe the instrument with such solutions.



CAUTION

Do not use abrasive powder or other polishing agents to wipe the instrument.

■ How to replace batteries

If  is displayed on the meter, the battery is low. Replace it with a new one as soon as possible (section 2.1).

When BATT LOW is displayed, the power turns off immediately.



CAUTION

When replacing batteries, do not mix new and old batteries or two different types of batteries.

7.3 Sensor Maintenance

This section describes general care for pH and ORP sensors.

7.3.1 How to clean the sensors

Contamination on the glass electrode and the liquid junction often causes measurement errors. Therefore, when measuring solutions containing contaminant components, they should be cleaned periodically according to the degree of contamination.



CAUTION

Do not apply physical shock or excessive force to the glass sensor, or it may break.

Particularly, do not rub the glass membrane hard. It may damage or break the glass membrane.

■ **For sediment, adhesive substances, microorganisms, oily substances, etc.**

Clean contaminants from the glass electrode, the liquid junction, and the temperature sensor. Wipe off with a cotton swab moistened with neutral detergent and rinse with water. If it is difficult to remove with a cotton swab, use a soft brush.

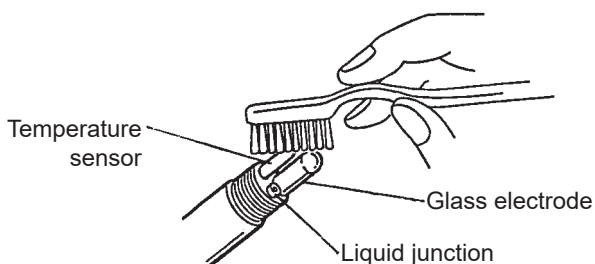

Figure 7.2 Cleaning electrode with brush

■ **For chemical contaminants**

Even if the sensor appears clean, chemical contamination might impair sensitivity.

Try cleaning the electrode by soaking it in dilute hydrochloric acid of about 0.1 mol/L (pH 1 to 2) for 10 to 20 minutes: acid cleaning. Note that electrodes deteriorate as they are used, and acid cleaning will not fully restore their performance.

NOTE

Dilute hydrochloric acid is available at pharmacies. Please handle with care.

When cleaning is complete, rinse off the cleaning solution from the electrode with water.

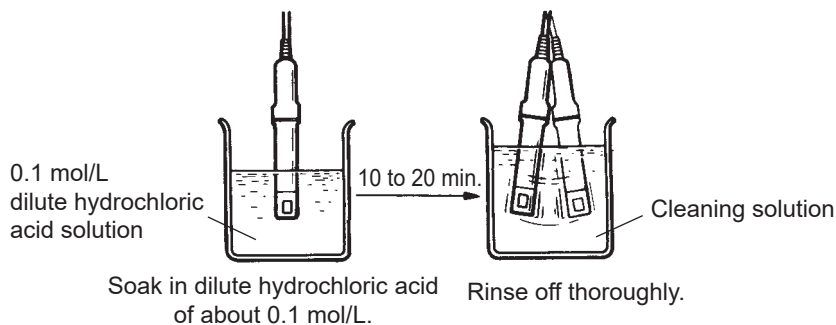

Figure 7.3 Acid cleaning

7.3.2 Refill KCl filling solution

For only KCl refillable type pH sensors.

The 3.3 mol/L KCl solution inside the electrode gradually drains out from the liquid junction during measurement. When the solution has decreased to less than 20 mm from the protective cover (Figure 7.4), replenish the supplied 3.3 mol/L KCl (potassium chloride) solution.



CAUTION

Handle syringes with care. Avoid touching needles when refilling the KCl solution.

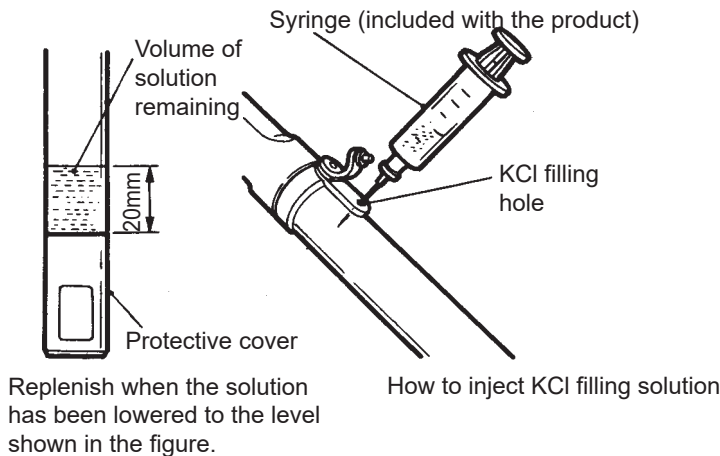

Figure 7.4 How to replenish the KCl filling solution

7.3.3 Moistening glass electrodes

Dried glass electrodes do not immediately provide a stable pH value. If the glass electrode has dried out, soak it in water (press water, etc.) for at least 1 to 2 hours. Stable pH value will be obtained.

7.3.4 Check oxidation-reduction potential

This section applies only when the ORP sensor is used.

The measured value obtained when measuring the check solution determines whether the ORP sensor is normal or not.

Use solutions with known redox potentials as check solutions. This section describes the check using “quinhydrone reagent,” which we provide as the optional accessories.

■ Preparation of quinhydrone solution

Dissolve one bag of reagent in a wide-mouth bottle (250 mL) and pour purified water to make a total solution of 250 mL.

If the temperature of the purified water is low, the reagent may not dissolve completely and may float on the surface of the solution, but this is not a problem for use.

Quinhydrone solution degrades over time, so it should be used on the same day as the day of preparation.

■ How to check ORP

- (1) Take about 50 to 100 mL of the prepared the quinhydrone solution and pour it into a clean container (200 mL).
- (2) If the electrode is contaminated with the sample solution, rinse it with press water and then wipe off the water droplets.
- (3) Immerse the tip of the electrode in the check solution and wait for the reading to stabilize. It usually takes about 5 to 10 minutes to stabilize.
- (4) When the reading stabilizes, read its ORP value and the liquid temperature. Confirm that it is within the allowable range (± 40 mV) shown in Figure 7. 5. If it is within the allowable range, the sensor is normal. If it is out of the allowable range, clean the sensor as described in 7.3.1 How to clean the sensors.

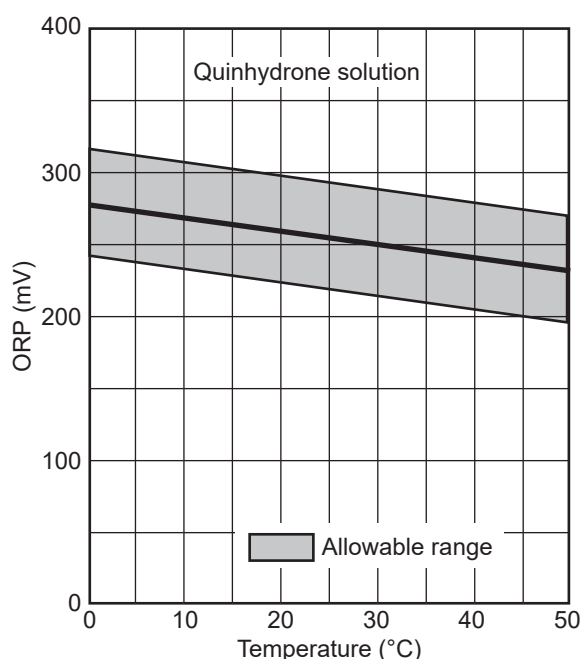

Figure 7.5 ORP of check solution

8. Trouble Shooting

If the following problems may occur: the pH reading does not stabilize easily during a measurement or calibration with buffer solution, an abnormal value is shown, an error message appears, the followings are the three main causes of these problems.

- Consumables have reached their expiration date.
- Insufficient maintenance. Or not handled correctly.
- A malfunction has occurred.

If an error occurs, read this chapter to find the cause and take appropriate measures. Contact us for any malfunctions that cannot be resolved by this chapter.

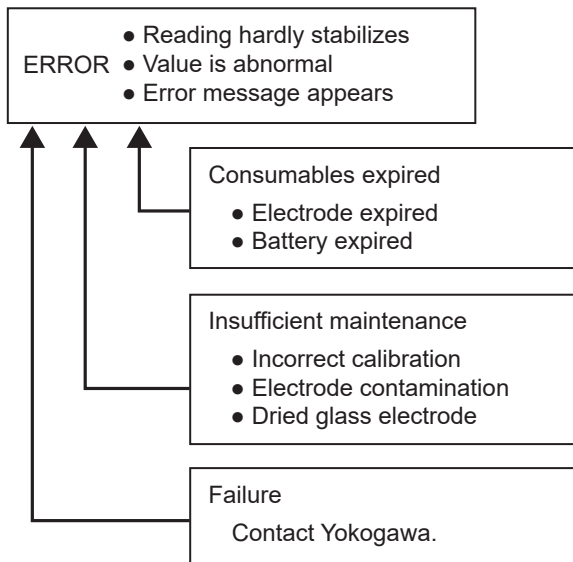

Figure 8.1 Causes of abnormalities

■ Error messages

If an error listed below appears during use, check the remedies in Table 8.1.

Table 8.1 Error messages

Meter display	Probable causes and remedies
BATT LOW	Battery power is low. Please replace with new batteries. (Section 2.1)
OFFS ERR	Offset voltage error Clean the sensor, erase the calibration data (Section 4.1.3), and try the calibration again. If the error still continues, replace the sensor with a new one.
SLPE ERR	Sensor sensitivity (Slope) is low. Clean the sensor, erase the calibration data (Section 4.1.3) and try the calibration again. If the error persists, replace the sensor with a new one.
BUFF ERR	The buffer solution cannot be automatically identified. Erase calibration data (Section 4.1.3), check the calibration solution, and use a new one if necessary.
MEM FULL	The number of stored data exceeded 500. Please delete the saved data. (Section 4.2.2)
Ur, Or	The measured value is outside the measurement range (Table 8.2 Other troubles)
NOT STBL	The ENT ● key was pressed before the calibration value stabilized. Wait for the value to be stable and then press the ENT ● key . ERR also appears.
⚠ (blinking)	Exceeds the setup calibration interval. Calibrate the meter. (Section 5.1)
ERR	Indicates invalid operation was done.

Other trouble shooting

Table 8.2 shows common problems, their causes, and remedies.

Table 8.2 Other troubles

Troubles	Probable causes	Remedies
Measured values are unstable.	Sensor is not connected properly	Connect the sensor correctly.
	Electrode is not properly immersed in the sample solution.	Check the depth of immersion.
	Air bubble at the tip of the sensor	Move the air bubble.
	KCl filling solution is insufficient quantity. (only KCl refillable type pH sensor)	Refill the KCl filling solution. (Section 7.3.1).
	Sensor is broken.	Replace the sensor.
	Sensor is dirty.	Clean the sensor. (Section 7.3.1).
	Sensor is dried.	Keep the sensor moist. (Section 7.3.3).
The response is slow	There is an external induction motor nearby.	Conduct the measurement in a location that is not affected by external induction. Ground all equipment connected to the AC power source.
	Sensor is dirty.	Clean the sensor. (Section 7.3.1)
The measured value is out of the measurement range*1	Sensor is broken.	Replace the sensor.
	Sample is out of the measurement range.	Use a sample within the measurement range.
	Sensor is not properly immersed in the sample solution.	Check the depth of immersion.
	Sensor cable is disconnected.	Replace the sensor.
Repeatability of the measured value is poor.	Uncalibrated or incorrectly calibrated	After clearing the calibration value, please perform the calibration correctly.
	Instrument defect	Contact YOKOGAWA.
	Effect of the sample solution.	Repeatability becomes poor when the pH of the sample changes over time.
	Sensor is dirty.	Clean the sensor. (Section 7.3.1)
Nothing appears when power is turned on	Sensor is broken.	Replace the sensor.
	The filling solution is depleted or contaminated.	Refill the KCl filling solution. (Section 7.3.2) If the problem persists, replace the sensor.
	Power is not supplied.	Insert batteries.
	Battery polarity (+, -) is reversed.	Insert the batteries with the polarity (+, -) correctly oriented.
Part of the display is missing.	Battery level is low	Replace the batteries.
	Instrument defect	Contact YOKOGAWA.
	Instrument defect	Power ON the instrument. Check the display while all the LCD segments are lit.

*1 "Ur" is displayed when the measured value is below the display range.
 "Or" is displayed if the measured value exceeds the display range.

Revision Record

- Manual Title : PH91 Portable pH Meter PH92 Portable pH/ORP Meter
- Manual No. : IM 12B03E00-02EN

Dec. 2024/3rd Edition

Corrected to include WEEE directive. (page vi)

Dec. 2024/2nd Edition

Compliant with KC marking product (pages v, vii)

Aug. 2024/1st Edition

Newly published

Yokogawa Electric Corporation
2-9-32 Nakacho, Musashino-shi, Tokyo 180-8750, JAPAN
<http://www.yokogawa.com/>



