

Overview



Pointek CLS300 (standard version) is an inverse frequency shift capacitance level and material detection switch with optional rod/cable choices and configurable output. CLS300 is ideal for detecting liquids, solids, slurries, foam, and interfaces in demanding conditions where high pressure and temperatures are present and has the ability to tune out buildup on the probe.

Benefits

- Active-Shield technology so measurement is unaffected by material buildup or nozzle interference in active shield section
- Performs in extremely abrasive conditions because of solid rod construction
- Three LED indicators for adjustment control, output status, and power
- High-temperature version up to 400 °C (752 °F)

Application

Pointek CLS300 standard version has three LED indicators with basic relay and solid-state switch alarms.

The robust design of CLS300 makes it specifically applicable for heavy solids applications where abrasive materials occur as in the mining industry. The fully potted electronics are unaffected by condensation, dust or vibration.

Wetted parts are made of stainless steel with a PFA shield for high chemical resistance, and of ceramic and stainless steel for high temperature version. Materials with low or high dielectric constants can be accurately detected. The unique Active Shield suppresses interference from material buildup or long installation nozzles.

The unique modular design of the Pointek CLS300 provides a wide range of configurations, process connections, extensions and approvals to meet the temperature and pressure requirements of specific applications. The modular design makes ordering easier and reduces stocking requirements. A wide range of probe configurations are available, including rod and cable versions.

- Key Applications: liquids, slurries, bulk solids, relatively high pressure and temperature, hazardous areas, milling and mining applications

Configuration

Installation

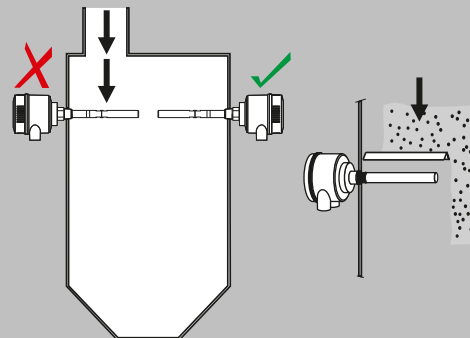

Keep unit out of path of falling material, or protect probe from falling material.

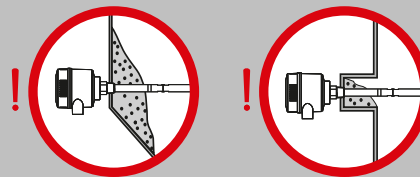

Build up of material in active shield area does not affect switch operation.

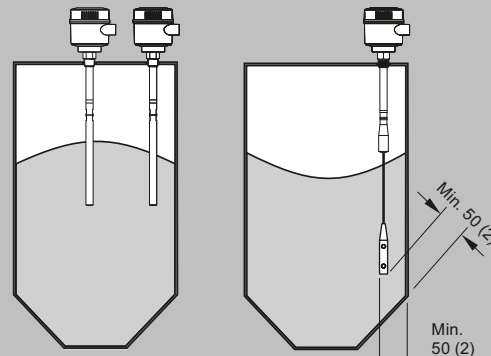

Install probe at least 50 (2) from tank wall.
Note angle of repose and adjust accordingly.

Pointek CLS300 installation, dimensions in mm (inch)

Pointek CLS300 - Standard

Selection and ordering data

Pointek CLS300 RF Capacitance point level switch, rod design. Detects level and interface in aggressive liquids, solids, slurries, and foam. Adjustable, 1 m (3.28 ft), insertion, adaptable sensitivity, with active shield to tune out build-up on probe.	Article No. 7ML5650- ● ● ● ● ● - ● ● ● ●		
Click on the Article No. for the online configuration in the PIA Life Cycle Portal.			
Process connection			
<u>Threaded, 316L stainless steel</u>			
¾" NPT [(Taper), ASME B1.20.1]	0	A	
1" NPT [(Taper), ASME B1.20.1]	0	B	
1¼" NPT [(Taper), ASME B1.20.1]	0	C	
1½" NPT [(Taper), ASME B1.20.1]	0	D	
R ¾" [(BSPT), EN 10226/PT (JIS-T), JIS B 0203]	1	A	
R 1" [(BSPT), EN 10226/PT (JIS-T), JIS B 0203]	1	B	
R 1½" [(BSPT), EN 10226/PT (JIS-T), JIS B 0203]	1	D	
G ¾" [(BSPP), EN ISO 228-1/PF (JIS-P), JIS B 0202]	3	A	
G 1" [(BSPP), EN ISO 228-1/PF (JIS-P), JIS B 0202]	3	B	
G 1½" [(BSPP), EN ISO 228-1/PF (JIS-P), JIS B 0202]	3	D	
<u>Welded flange, 316L stainless steel, raised face</u>			
1" ASME, 150 lb	5	A	
1" ASME, 300 lb	5	B	
1" ASME, 600 lb	5	C	
1½" ASME, 150 lb	5	D	
1½" ASME, 300 lb	5	E	
1½" ASME, 600 lb	5	F	
2" ASME, 150 lb	5	G	
2" ASME, 300 lb	5	H	
2" ASME, 600 lb	5	J	
3" ASME, 150 lb	5	K	
3" ASME, 300 lb	5	L	
3" ASME, 600 lb	5	M	
4" ASME, 150 lb	5	N	
4" ASME, 300 lb	5	P	
4" ASME, 600 lb	5	Q	
<u>Welded flange, 316L stainless steel, Type A flat faced</u>			
DN 25, PN 16	6	A	
DN 25, PN 40	6	B	
DN 40, PN 16	6	C	
DN 40, PN 40	6	D	
DN 50, PN 16	6	E	
DN 50, PN 40	6	F	
DN 80, PN 16	6	G	
DN 80, PN 40	6	H	
DN 100, PN 16	6	J	
DN 100, PN 40 (Note: flange bolting patterns and facings dimensionally correspond to the applicable ASME B16.5 or EN 1092-1 standard.)	6	K	
Probe length			
(length from flange face) (threaded lengths include process thread)			
<u>Note: No Y01 needed in Order code for standard lengths</u>			
Standard version, rod 350 mm (13.78 inch)		A	
Extended rod, length 500 mm (19.69 inch)		B	
Extended rod, length 750 mm (29.53 inch)		C	
Extended rod, length 1 000 mm (39.37 inch)		D	
<u>Add Order code Y01 and plain text: "Insertion length ... mm"</u>			
Extended rod, factory adjusted length 250 ... 499 mm (9.8 ... 19.65 inch)		E	
Extended rod, factory adjusted length 500 ... 749 mm (19.69 ... 29.49 inch)		F	
Extended rod, factory adjusted length 750 ... 999 mm (29.53 ... 39.3 inch)		G	
Thermal isolator			
Without thermal isolator			0
With thermal isolator [for process connection temperatures over 85 °C (185 °F)]			1

Selection and ordering data (continued)

Pointek CLS300 RF Capacitance point level switch, rod design. Detects level and interface in aggressive liquids, solids, slurries, and foam. Adjustable, 1 m (3.28 ft), insertion, adaptable sensitivity, with active shield to tune out build-up on probe.	Article No. 7ML5650- ● ● ● ● ● - ● ● ● ● ●
Wetted seals	
FKM	0
FFKM [for process temperatures above -20 °C (-4 °F)]	1
Probe material	
316L stainless steel with PFA lining and PEEK isolators	0
Approvals	
Dust Ignition Proof with IS Probe: CE, UKCA, RCM, ATEX II 1/2 D Ex ia/tb [ia Da] IIIC TX Da/Db, UKEX II 1/2 D Ex ia/tb [ia Da] IIIC TX Da/Db	C
Flameproof Enclosure with IS Probe: CE, UKCA, RCM, ATEX II 1/2 G Ex ia/db [ia Ga] IIC TX Ga/Gb, ATEX II 1/2 D Ex ia/tb [ia Da] IIIC TX Da/Db, UKEX II 1/2 G Ex ia/db [ia Ga] IIC TX Ga/Gb, UKEX II 1/2 D Ex ia/tb [ia Da] IIIC TX Da/Db	D
Flameproof Enclosure with IS Probe, with Overfill Protection: CE, UKCA, RCM, WHG, ATEX II 1/2 G Ex ia/db [ia Ga] IIC TX Ga/Gb, ATEX II 1/2 D Ex ia/tb [ia Da] IIIC TX Da/Db, UKEX II 1/2 G Ex ia/db [ia Ga] IIC TX Ga/Gb, UKEX II 1/2 D Ex ia/tb [ia Da] IIIC TX Da/Db	E
Dust Ignition Proof with IS Probe: CSA/ FM Class II, III Div. 1 Gr. E, F, G T4	F
Explosion Proof Enclosure with IS Probe: CSA/ FM Class I, II, III Div. 1 Gr. A, B, C, D, E, F, G T4	G
General Purpose CSA, FM	H
Ordinary Locations/General Purpose (Non-Ex): CE, UKCA, RCM	J
Ordinary Locations/General Purpose (Non-Ex) with Overfill Protection: CSA, FM, CE, UKCA, RCM, WHG	K
Enclosure and lid	
Aluminum epoxy coated	
2 x ½" NPT via adapter - cable inlet, IP65	A
2 x M20 x 1.5 cable inlet, IP65	B
2 x ½" NPT via adapter - cable inlet, IP68	C
2 x M20 x 1.5 cable inlet, IP68	D
Active shield length	
Standard length - (125 mm threaded, 105 mm flanged)	0
Extended shield - (250 mm threaded, 230 mm flanged) ¹⁾	1
Extended shield - (400 mm threaded, 380 mm flanged) ²⁾	2

¹⁾ Available with Probe version options B ... D, F, G only [≥ 500 mm (19.69 inch)].

²⁾ Available with Probe version options C, D, and G only [≥ 750 mm (29.53 inch)].

Selection and Ordering data	Order code
Further designs	
Please add "-Z" to Article No. and specify Order code(s).	
Total insertion length: enter the total insertion length in plain text description	Y01
Stainless steel tag [70 x 13 mm (2.75 x 0.5 inch)]: Measuring-point number/identification (max. 27 characters) specify in plain text	Y15
Manufacturer's test certificate: M to DIN 55350, Part 18 and to ISO 9000	C11
Material Inspection Certificate Type 3.1 per EN 10204	C12
INMETRO ¹⁾	E34

Selection and Ordering data	Order code
Operating Instructions	
All literature is available to download for free, in a range of languages, at http://www.siemens.com/processinstrumentation/documentation .	
Accessories	See accessories following CLS300 Digital selection and ordering data.

¹⁾ Available only with Approvals options C, D, E.

Pointek CLS300 - Standard

Selection and ordering data (continued)

	Article No.	
Pointek CLS300 RF Capacitance point level switch, cable design. Detects level and interface in aggressive liquids, solids, slurries, and foam. Cable extension options to 25 m (82.02 ft), adaptable sensitivity, with active shield to tune out build-up on probe.	7ML5651- ● ● ● ● ● - ● ● ● ●	
Click on the Article No. for the online configuration in the PIA Life Cycle Portal.		
Process connection		
<u>Threaded, 316L stainless steel</u>		
1¼" NPT [(Taper), ASME B1.20.1]	0	C
1½" NPT [(Taper), ASME B1.20.1]	0	D
R 1½" [(BSPT), EN 10226/PT (JIS-T), JIS B 0203]	1	D
G 1½" [(BSPP), EN ISO 228-1/PF (JIS-P), JIS B 0202]	3	D
<u>Welded flange, 316L stainless steel, raised face</u>		
1½" ASME, 150 lb	5	D
1½" ASME, 300 lb	5	E
1½" ASME, 600 lb	5	F
2" ASME, 150 lb	5	G
2" ASME, 300 lb	5	H
2" ASME, 600 lb	5	J
3" ASME, 150 lb	5	K
3" ASME, 300 lb	5	L
3" ASME, 600 lb	5	M
4" ASME, 150 lb	5	N
4" ASME, 300 lb	5	P
4" ASME, 600 lb	5	Q
<u>Welded flange, 316L stainless steel, Type A flat faced</u>		
DN 40, PN 16	6	C
DN 40, PN 40	6	D
DN 50, PN 16	6	E
DN 50, PN 40	6	F
DN 80, PN 16	6	G
DN 80, PN 40	6	H
DN 100, PN 16	6	J
DN 100, PN 40	6	K
(Note: Flange bolting patterns and facings dimensionally correspond to the applicable ASME B16.5 or EN 1092-1 standard.)		
Probe length (length from flange face) (threaded lengths include process thread)		
<u>Note: No Y01 needed in Order code for standard lengths</u>		
Extended cable, 3 000 mm (118.11 inch), length can be shortened by customer		A
Extended cable, 6 000 mm (236.22 inch), length can be shortened by customer		B
<u>Add Order code Y01 and plain text: "Insertion length ... mm"</u>		
Extended cable, 500 ... 1 000 mm (19.69 ... 39.37 inch) ²⁾		E
Extended cable, 1 001 ... 5 000 mm (39.41 ... 196.85 inch)		F
Extended cable, 5 001 ... 10 000 mm (196.89 ... 393.70 inch)		G
Extended cable, 10 001 ... 15 000 mm (393.74 ... 590.55 inch)		H
Extended cable, 15 001 ... 20 000 mm (590.59 ... 787.40 inch)		J
Extended cable, 20 001 ... 25 000 mm (787.44 ... 984.25 inch)		K
Thermal isolator		
Without thermal isolator		0
With thermal isolator [for process connection temperatures over 85 °C (185 °F)]		1
Wetted seals		
FKM		0
FFKM [for process temperatures above -20 °C (-4 °F)]		1
Probe material		
Bare 316L stainless steel cable, PEEK isolators and 316L stainless steel cable weight		0
PFA coated cable, PEEK isolators and 316L stainless steel cable weight		1

Selection and ordering data (continued)

Pointek CLS300 RF Capacitance point level switch, cable design. Detects level and interface in aggressive liquids, solids, slurries, and foam. Cable extension options to 25 m (82.02 ft), adaptable sensitivity, with active shield to tune out build-up on probe.	Article No. 7ML5651- ● ● ● ● ● - ● ● ● ●											
Approvals Dust Ignition Proof with IS Probe: CE, UKCA, RCM, ATEX II 1/2 D Ex ia/tb [ia Da] IIIC TX Da/Db, UKEX II 1/2 D Ex ia/tb [ia Da] IIIC TX Da/Db Flameproof Enclosure with IS Probe: CE, UKCA, RCM, ATEX II 1/2 G Ex ia/db [ia Ga] IIC TX Ga/Gb, ATEX II 1/2 D Ex ia/tb [ia Da] IIIC TX Da/Db UKEX II 1/2 G Ex ia/db [ia Ga] IIC TX Ga/Gb, UKEX II 1/2 D Ex ia/tb [ia Da] IIIC TX Da/Db Flameproof Enclosure with IS Probe, with Overfill Protection: CE, UKCA, RCM, WHG, ATEX II 1/2 G Ex ia/db [ia Ga] IIC TX Ga/Gb, ATEX II 1/2 D Ex ia/tb [ia Da] IIIC TX Da/Db UKEX II 1/2 G Ex ia/db [ia Ga] IIC TX Ga/Gb, UKEX II 1/2 D Ex ia/tb [ia Da] IIIC TX Da/Db Dust Ignition Proof with IS Probe: CSA/ FM Class II, III Div. 1 Gr. E, F, G T4 Explosion Proof Enclosure with IS Probe: CSA/ FM Class I, II, III Div. 1 Gr. A, B, C, D, E, F, G T4 General Purpose CSA, FM Ordinary Locations/General Purpose (Non-Ex): CE, UKCA, RCM Ordinary Locations/General Purpose (Non-Ex) with Overfill Protection: CSA, FM, CE, UKCA, RCM, WHG											C	
											D	
											E	
											F	
											G	
											H	
											J	
											K	
Enclosure and lid Aluminum epoxy coated 2 x ½" NPT via adapter - cable inlet, IP65 2 x M20 x 1.5 cable inlet, IP65 2 x ½" NPT via adapter - cable inlet, IP68 2 x M20 x 1.5 cable inlet, IP68											A	
											B	
											C	
											D	
Active shield length Standard length - (125 mm threaded, 105 mm flanged) Extended shield - (250 mm threaded, 230 mm flanged) ¹⁾ Extended shield - (400 mm threaded, 380 mm flanged) ¹⁾											0	
											1	
											2	

¹⁾ Available with Probe version options A, B, F ... K, only [$\geq 1\,000$ mm (39.7 inch)].

²⁾ Not available with Active shield option 1.

Selection and Ordering data	Order code
Further designs	
Please add "-Z" to Article No. and specify Order code(s).	
Total insertion length: enter the total insertion length in plain text description	Y01
Stainless steel tag [70 x 13 mm (2.75 x 0.5 inch)]: Measuring-point number/identification (max. 27 characters) specify in plain text	Y15
Manufacturer's test certificate: M to DIN 55350, Part 18 and to ISO 9000	C11
Material Inspection Certificate Type 3.1 per EN 10204 INMETRO ¹⁾	C12 E34

Selection and Ordering data	Order code
Operating Instructions	
All literature is available to download for free, in a range of languages, at http://www.siemens.com/processinstrumentation/documentation .	
Accessories	See accessories following CLS300 Digital selection and ordering data.

¹⁾ Available only with Approvals options C, D, E.

Pointek CLS300 - Standard

Selection and ordering data (continued)

	Article No.	
Pointek CLS300 RF Capacitance point level switch, high temperature design. Detects level and interface in aggressive liquids, solids, slurries, and foam. Adjustable, 1 m (3.28 ft), insertion, adaptable sensitivity, with active shield to tune out build-up on probe.	7ML5652-	● ● ● 0 ● - ● ● ● ●
Click on the Article No. for the online configuration in the PIA Life Cycle Portal.		
Process connection		
<u>Threaded, 316L stainless steel</u>		
¾" NPT [(Taper), ASME B1.20.1]	0	A
1" NPT [(Taper), ASME B1.20.1]	0	B
1¼" NPT [(Taper), ASME B1.20.1]	0	C
1½" NPT [(Taper), ASME B1.20.1]	0	D
R ¾" [(BSPT), EN 10226/PT (JIS-T), JIS B 0203]	1	A
R 1" [(BSPT), EN 10226/PT (JIS-T), JIS B 0203]	1	B
R 1½" [(BSPT), EN 10226/PT (JIS-T), JIS B 0203]	1	D
G ¾" [(BSPP), EN ISO 228-1/PF (JIS-P), JIS B 0202]	3	A
G 1" [(BSPP), EN ISO 228-1/PF (JIS-P), JIS B 0202]	3	B
G 1½" [(BSPP), EN ISO 228-1/PF (JIS-P), JIS B 0202]	3	D
<u>Welded flange, 316L stainless steel, raised face</u>		
1" ASME, 150 lb	5	A
1" ASME, 300 lb	5	B
1" ASME, 600 lb	5	C
1½" ASME, 150 lb	5	D
1½" ASME, 300 lb	5	E
1½" ASME, 600 lb	5	F
2" ASME, 150 lb	5	G
2" ASME, 300 lb	5	H
2" ASME, 600 lb	5	J
3" ASME, 150 lb	5	K
3" ASME, 300 lb	5	L
3" ASME, 600 lb	5	M
4" ASME, 150 lb	5	N
4" ASME, 300 lb	5	P
4" ASME, 600 lb	5	Q
<u>Welded flange, 316L stainless steel, Type A flat faced</u>		
DN 25, PN 16	6	A
DN 25, PN 40	6	B
DN 40, PN 16	6	C
DN 40, PN 40	6	D
DN 50, PN 16	6	E
DN 50, PN 40	6	F
DN 80, PN 16	6	G
DN 80, PN 40	6	H
DN 100, PN 16	6	J
DN 100, PN 40	6	K
(Note: Flange bolting patterns and facings dimensionally correspond to the applicable ASME B16.5 or EN 1092-1 standard.)		
Probe length		
(length from flange face) (threaded lengths include process thread)		
<u>Note: No Y01 needed in Order code for standard lengths</u>		
Standard version rod, 350 mm (13.78 inch)		A
Extended rod, length 500 mm (19.69 inch)		B
Extended rod, length 750 mm (29.53 inch)		C
Extended rod, length 1 000 mm (39.37 inch)		D
<u>Add Order code Y01 and plain text: "Insertion length ... mm"</u>		
Extended rod, factory adjusted length 250 ... 499 mm (9.8 ... 19.65 inch)		E
Extended rod, factory adjusted length 500 ... 749 mm (19.69 ... 29.49 inch)		F
Extended rod, factory adjusted length 750 ... 999 mm (29.53 ... 39.3 inch)		G

Selection and ordering data (continued)

	Article No.
Pointek CLS300 RF Capacitance point level switch, high temperature design. Detects level and interface in aggressive liquids, solids, slurries, and foam. Adjustable, 1 m (3.28 ft), insertion, adaptable sensitivity, with active shield to tune out build-up on probe.	7ML5652- ● ● ● 0 ● - ● ● ● ●
Wetted seals	
Graphite	0
Probe material	
316L stainless steel with ceramic (ZrO ₂) isolators	0
Approvals	
Dust Ignition Proof with IS Probe: CE, UKCA, RCM, ATEX II 1/2 D Ex ia/tb [ia Da] IIIC TX Da/Db, UKEX II 1/2 D Ex ia/tb [ia Da] IIIC TX Da/Db	C
Flameproof Enclosure with IS Probe: CE, UKCA, RCM, ATEX II 1/2 G Ex ia/db [ia Ga] IIC TX Ga/Gb, ATEX II 1/2 D Ex ia/tb [ia Da] IIIC TX Da/Db UKEX II 1/2 G Ex ia/db [ia Ga] IIC TX Ga/Gb, UKEX II 1/2 D Ex ia/tb [ia Da] IIIC TX Da/Db	D
Flameproof Enclosure with IS Probe, with Overfill Protection: CE, UKCA, RCM, WHG, ATEX II 1/2 G Ex ia/db [ia Ga] IIC TX Ga/Gb, ATEX II 1/2 D Ex ia/tb [ia Da] IIIC TX Da/Db UKEX II 1/2 G Ex ia/db [ia Ga] IIC TX Ga/Gb, UKEX II 1/2 D Ex ia/tb [ia Da] IIIC TX Da/Db	E
Dust Ignition Proof with IS Probe: CSA/ FM Class II, III Div. 1 Gr. E, F, G T4	F
Explosion Proof Enclosure with IS Probe: CSA/ FM Class I, II, III Div. 1 Gr. A, B, C, D, E, F, G T4	G
General Purpose CSA, FM	H
Ordinary Locations/General Purpose (Non-Ex): CE, UKCA, RCM	J
Ordinary Locations/General Purpose (Non-Ex) with Overfill Protection: CSA, FM, CE, UKCA, RCM, WHG	K
Enclosure and lid	
Aluminum epoxy coated	
2 x 1/2" NPT via adapter - cable inlet, IP65	A
2 x M20 x 1.5 cable inlet, IP65	B
2 x 1/2" NPT via adapter - cable inlet, IP68	C
2 x M20 x 1.5 cable inlet, IP68	D
Active shield length	
Standard length - (125 mm threaded, 105 mm flanged)	0
Extended shield - (250 mm threaded, 230 mm flanged) ¹⁾	1
Extended shield - (400 mm threaded, 380 mm flanged) ²⁾	2

¹⁾ Available with Probe version options B ... D, F, G only [\geq 500 mm (19.69 inch)].

²⁾ Available with Probe version options C, D, and G only [\geq 750 mm (29.53 inch)].

Selection and Ordering data	Order code
Further designs	
Please add "-Z" to Article No. and specify Order code(s).	
Total insertion length: enter the total insertion length in plain text description ¹⁾	Y01
Stainless steel tag [70 x 13 mm (2.75 x 0.5 inch)]: Measuring-point number/identification (max. 27 characters) specify in plain text	Y15
Manufacturer's test certificate: M to DIN 55350, Part 18 and to ISO 9000	C11
Material Inspection Certificate Type 3.1 per EN 10204 INMETRO ²⁾	C12 E34

Selection and Ordering data	Order code
Operating Instructions	
All literature is available to download for free, in a range of languages, at http://www.siemens.com/processinstrumentation/documentation .	
Accessories	See accessories following CLS300 Digital selection and ordering data.

¹⁾ Not available with Probe length option B.

²⁾ Available only with Approvals options C, D, E.

Pointek CLS300 - Standard

Technical specifications

Pointek CLS300 - Standard	
Mode of operation	
Measuring principle	Inverse frequency shift capacitive level detection
Input	
Measured variable	Change in picoFarad (pF)
Output	
Output signal	
• Relay output	1 SPDT Form C relay
- Max. contact voltage	<ul style="list-style-type: none"> • 30 V DC • 250 V AC
- Max. contact current	<ul style="list-style-type: none"> • 5 A (DC) • 8 A (AC)
- Max. switching capacity	<ul style="list-style-type: none"> • 150 W (DC) • 2 000 VA (AC)
- Time delay (ON and/or OFF)	1 ... 60 s
• Solid-state output	
- Output	Galvanically isolated
- Protection	Against reversed polarity (bipolar)
- Max. switching voltage	<ul style="list-style-type: none"> • 30 V (DC) • 30 V peak (AC)
- Max. load current	82 mA
- Voltage drop	< 1 V, typical at 50 mA
- Time delay (pre or post switching)	1 ... 60 s
Accuracy	
Resolution	
• Min. sensitivity (pF)	1 % change in actual capacitance
• Max. temperature error	0.2 % of actual capacitance value
Rated operating conditions¹⁾	
Installation conditions	
• Location	Indoor/outdoor
Ambient conditions	
• Ambient temperature	-40 ... +85 °C (-40 ... +185 °F) ²⁾
• Storage temperature	-40 ... +85 °C (-40 ... +185 °F)
Medium conditions	Liquids, bulk solids, slurries and interfaces, and applications with viscous materials
• Relative dielectric constant ϵ_r	Min. 1.5
• Process temperature	
- Rod/Cable version	-40 ... +200 °C (-40 ... +392 °F) ²⁾
- High-temperature version	-40 ... +400 °C (-40 ... +752 °F)
• Process pressure ³⁾	-1 ... +35 bar g (-14.6 ... +511 psi g)

Pointek CLS300 - Standard	
Design	
Material (enclosure)	Powder-coated aluminum with gasket
Degree of Protection	Standard: Type 4/NEMA 4/IP65 Optional: Type 4/NEMA 4/IP68
Cable inlet	2 x M20 x 1.5 thread (option: 2 x 1/2" NPT conduit entry including 1 plugged entry)
Controls and displays	
Displays	3 LEDs, for probe status, output status and power supply
Potentiometers	2 potentiometers for time delay and sensitivity
Switches	5 DIP switches for delay on/off, fail-safe high/low, time delay test/adjust, high/low sensitivity, test delay settings
Power supply	
Supply	12 ... 250 V AC/DC, 0 ... 60 Hz, galvanically isolated, 2 W
Certificates and approvals	
General Purpose	CSA, FM, CE, UKCA, RCM
Flameproof Enclosure with IS Probe	ATEX II 1/2 G Ex ia/db [ia Ga] IIC TX Ga/Gb, ATEX II 1/2 D Ex ia/tb [ia Da] IIIC TX Da/Db, UKEX II 1/2 G Ex ia/db [ia Ga] IIC TX Ga/Gb, UKEX ATEX II 1/2 D Ex ia/tb [ia Da] IIIC TX Da/Db
Dust Ignition Proof with IS Probe	ATEX II 1/2 D Ex ia/tb [ia Da] IIIC TX Da/Db, UKEX II 1/2 D Ex ia/tb [ia Da] IIIC TX Da/Db, CSA/IFM Class II, Div. 1, Groups E, F, G, CSA/IFM Class III T4
Explosion Proof Enclosure with IS Probe	CSA/IFM Class I, Div. 1, Groups A, B, C, D, CSA/IFM Class II, Div. 1, Groups E, F, G, CSA/IFM Class III T4
Marine	Lloyds Register of Shipping, Categories ENV1, ENV2, and ENV5
Overfill Protection	WHG (Germany) VLAREM II (Belgium)
Others	Pattern Approval (China)

- 1) When operation is in areas classified as hazardous, observe restrictions according to relevant certificate. See also CLS300 pressure/temperature curves.
- 2) Thermal isolator is used if process connection temperature exceeds 85 °C (185 °F).
- 3) Pressure rating of process seal is temperature dependent. See also CLS300 pressure/temperature curves.

Design: Probe	Rod version	High Temperature version	Cable version
Length	Min. 250 mm (9.8 inch), max. 1 000 mm (40 inch)	Min. 250 mm (9.8 inch), max. 1 000 mm (40 inch)	Min. 1 000 mm (40 inch), max. 25 000 mm (984 inch)
Sensor wetted parts	PFA (no insulation on active probe), 316L stainless steel, PEEK isolators	Ceramic (ZrO ₂ ¹⁾ isolators (no insulation on active probe), 316L stainless steel	316 stainless steel, optional PFA, PEEK isolators
O-ring seal material	FKM (optional FFKM) ²⁾	Graphite ²⁾	FKM (optional FFKM) ²⁾
Thermal isolator	Optional	Standard	Optional
Extension	User-selectable length	User-selectable length	User selectable cable length

¹⁾ Zirconium Oxide

²⁾ For caustic materials, consult a local sales person for alternative O-rings. For more information, please visit http://www.automation.siemens.com/aspa_app.

Characteristic curves

Pressure/temperature curve
CLS300 extended rod and cable probes
Threaded process connections
(7ML5650, 7ML5651, 7ML5660 and 7ML5661)

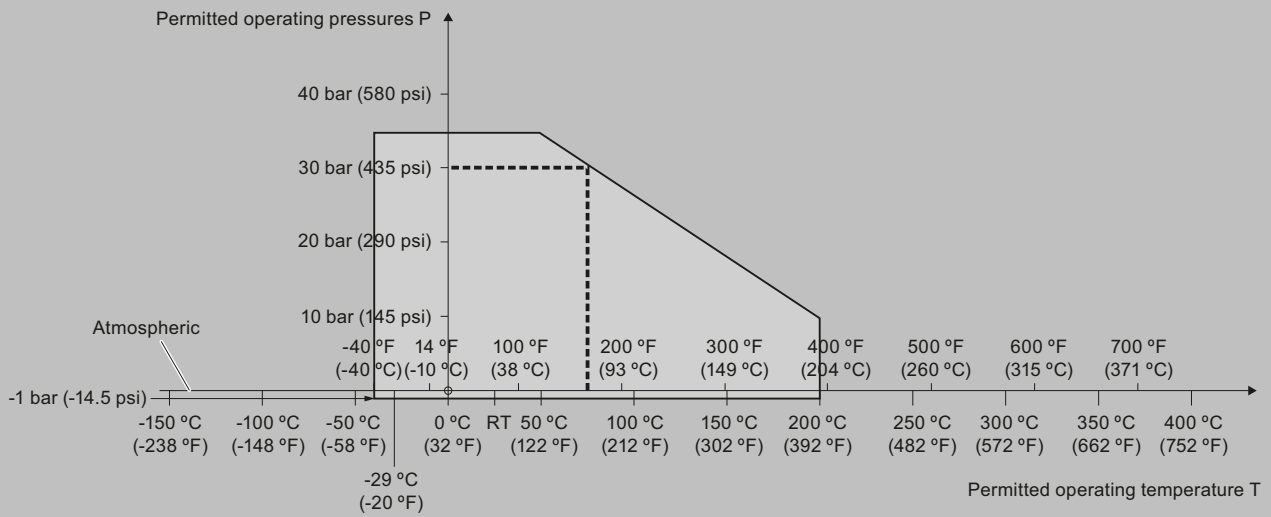

--- Example:
 Permitted operating pressure = 30 bar (435 psi) at 75 °C

Pointek CLS300 process pressure/temperature derating curves (7ML5650, 7ML5651, 7ML5660, and 7ML5661)

Pressure/temperature curve
CLS300 high temperature rod probes
Threaded process connections
(7ML5652 and 7ML5662)

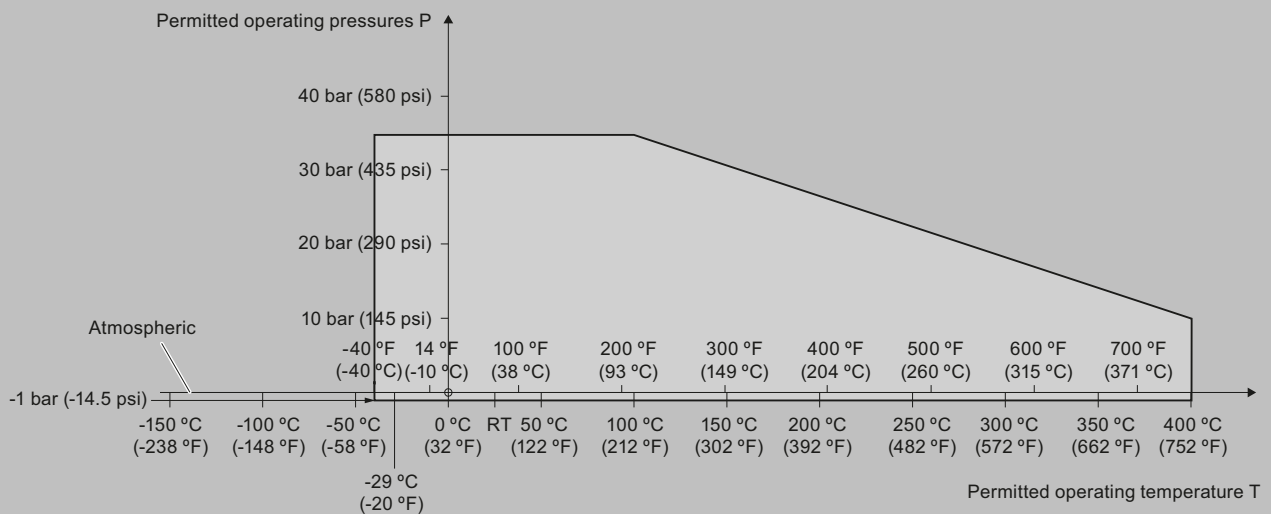

Pointek CLS300 process pressure/temperature derating curves (7ML5652 and 7ML5662)

Pointek CLS300 - Standard

Characteristic curves (continued)

Pressure/temperature curve
 CLS300 extended rod and cable probes
 ASME flanged process connections
 (7ML5650, 7ML5651, 7ML5660 and 7ML5661)

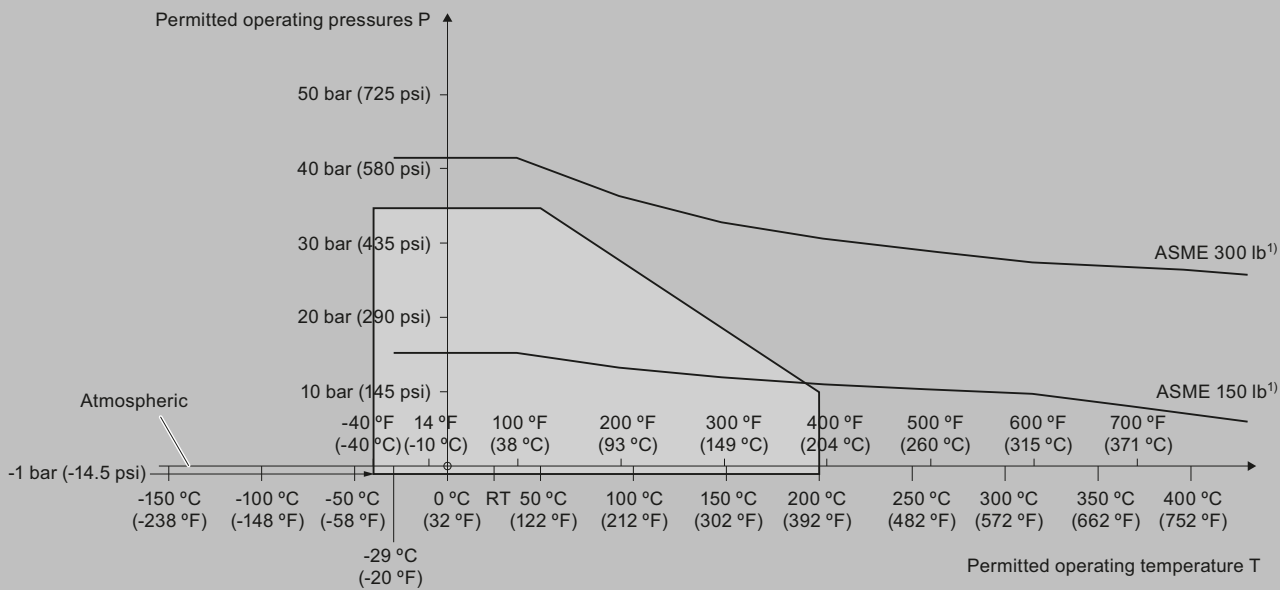

¹⁾ The curve denotes the minimum allowable flange class for the shaded area below.

Pointek CLS300 process pressure/temperature derating curves (7ML5650, 7ML5651, 7ML5660, and 7ML5661)

Characteristic curves (continued)

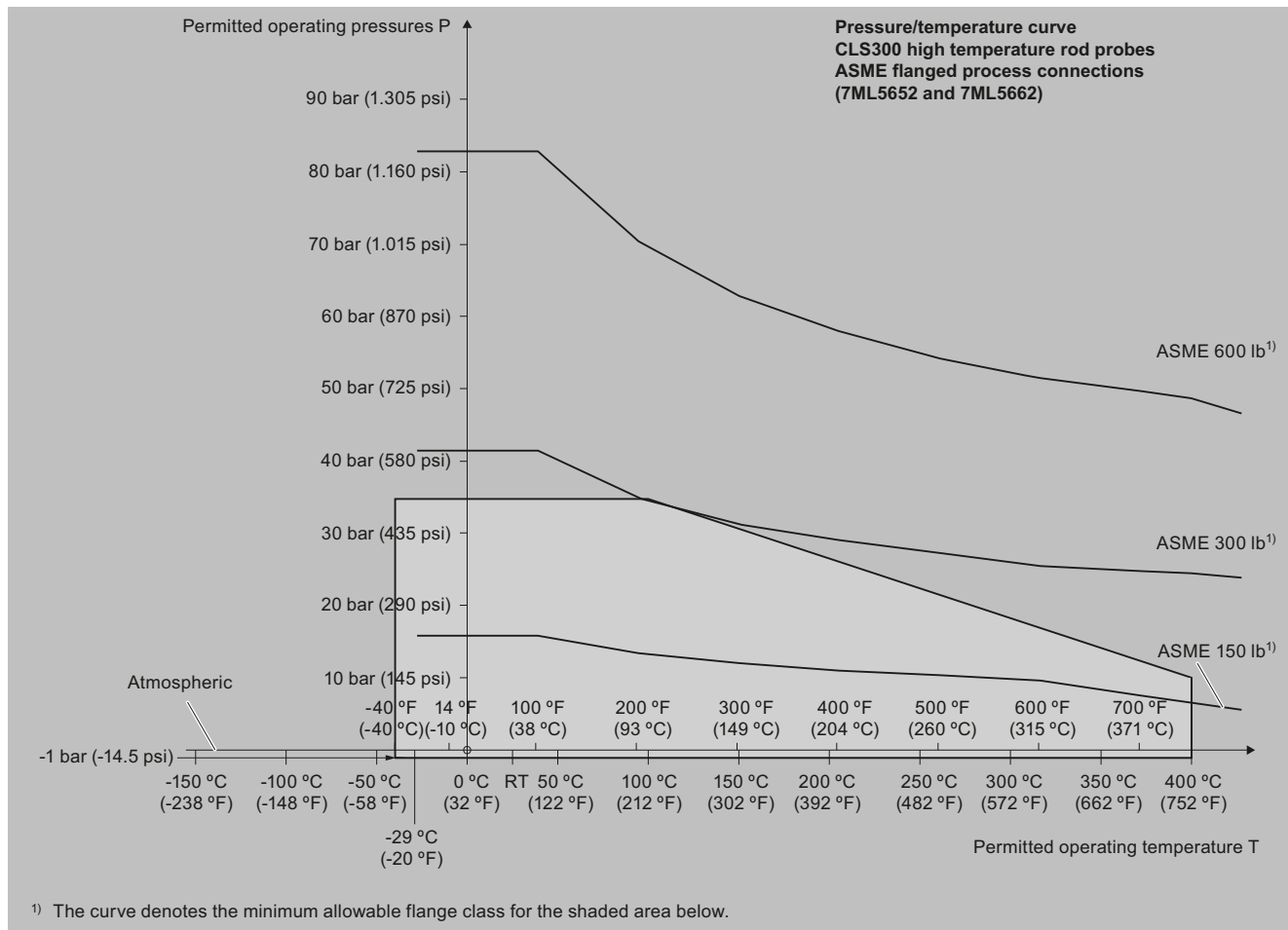

Pointek CLS300 process pressure/temperature derating curves (7ML5652 and 7ML5662)

Pointek CLS300 - Standard

Characteristic curves (continued)

Pressure/temperature curve
CLS300 extended rod and cable probes
EN flanged process connections
(7ML5650, 7ML5651, 7ML5660 and 7ML5661)

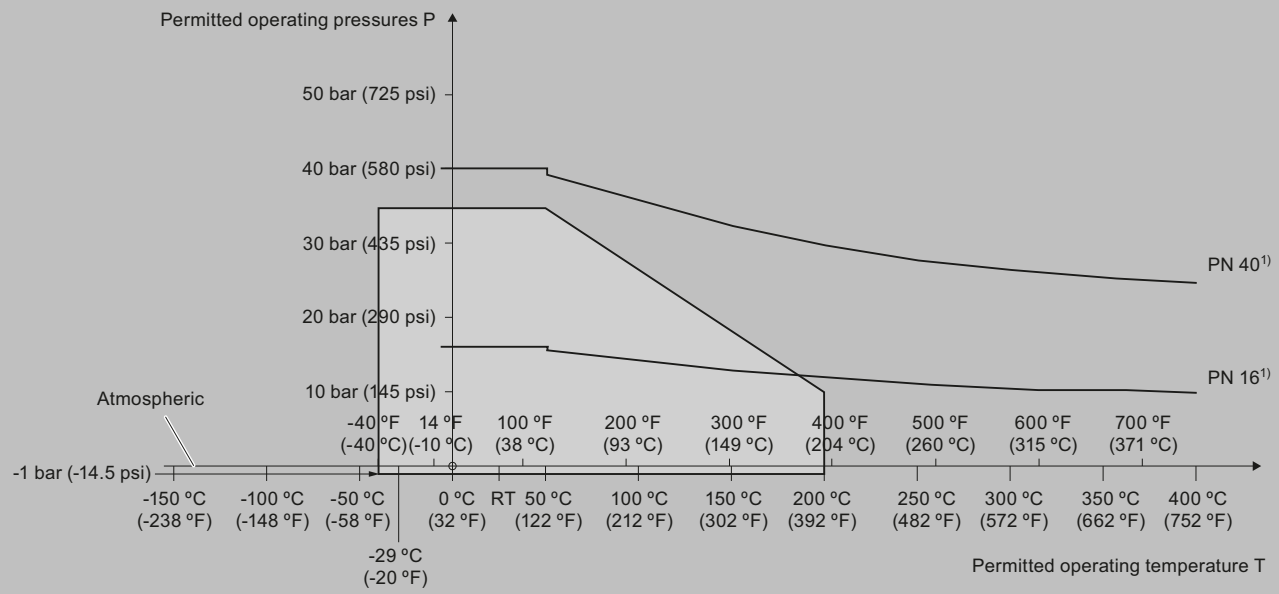

¹⁾ The curve denotes the minimum allowable flange class for the shaded area below.

Pointek CLS300 process pressure/temperature derating curves (7ML5650, 7ML5651, 7ML5660, and 7ML5661)

Pressure/Temperature Curve
CLS300 High Temperature Rod Probes
EN Flanged Process Connections (7ML5652 and 7ML5662)

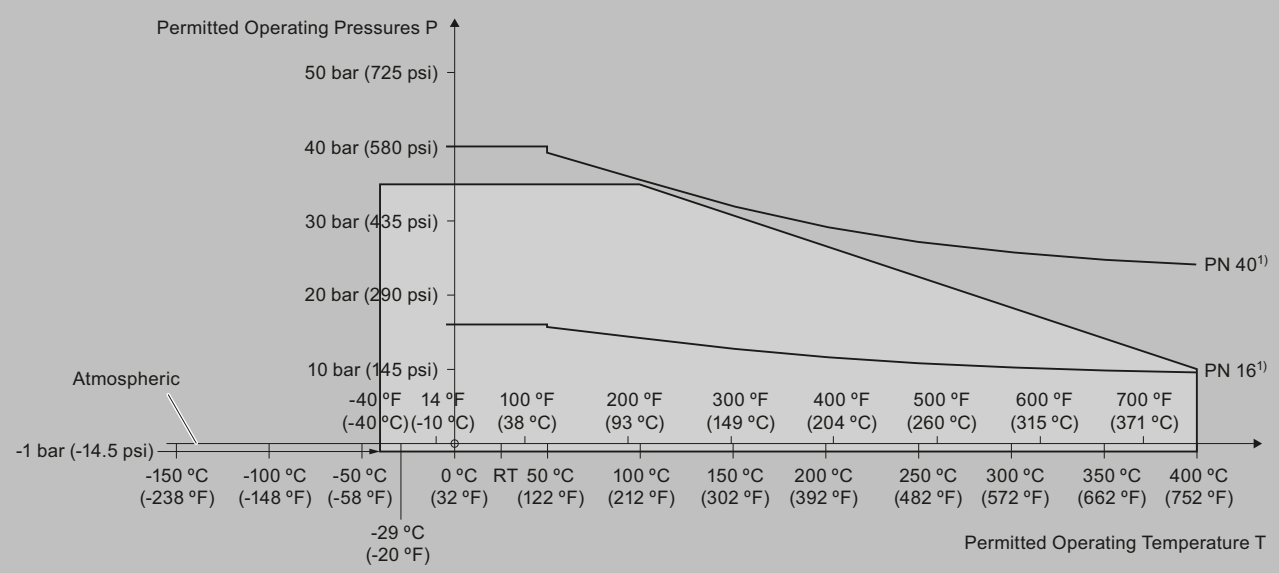

¹⁾ The curve denotes the minimum allowable flange class for the shaded area below.

Pointek CLS300 process pressure/temperature derating curves (7ML5652 and 7ML5662)

Dimensional drawings

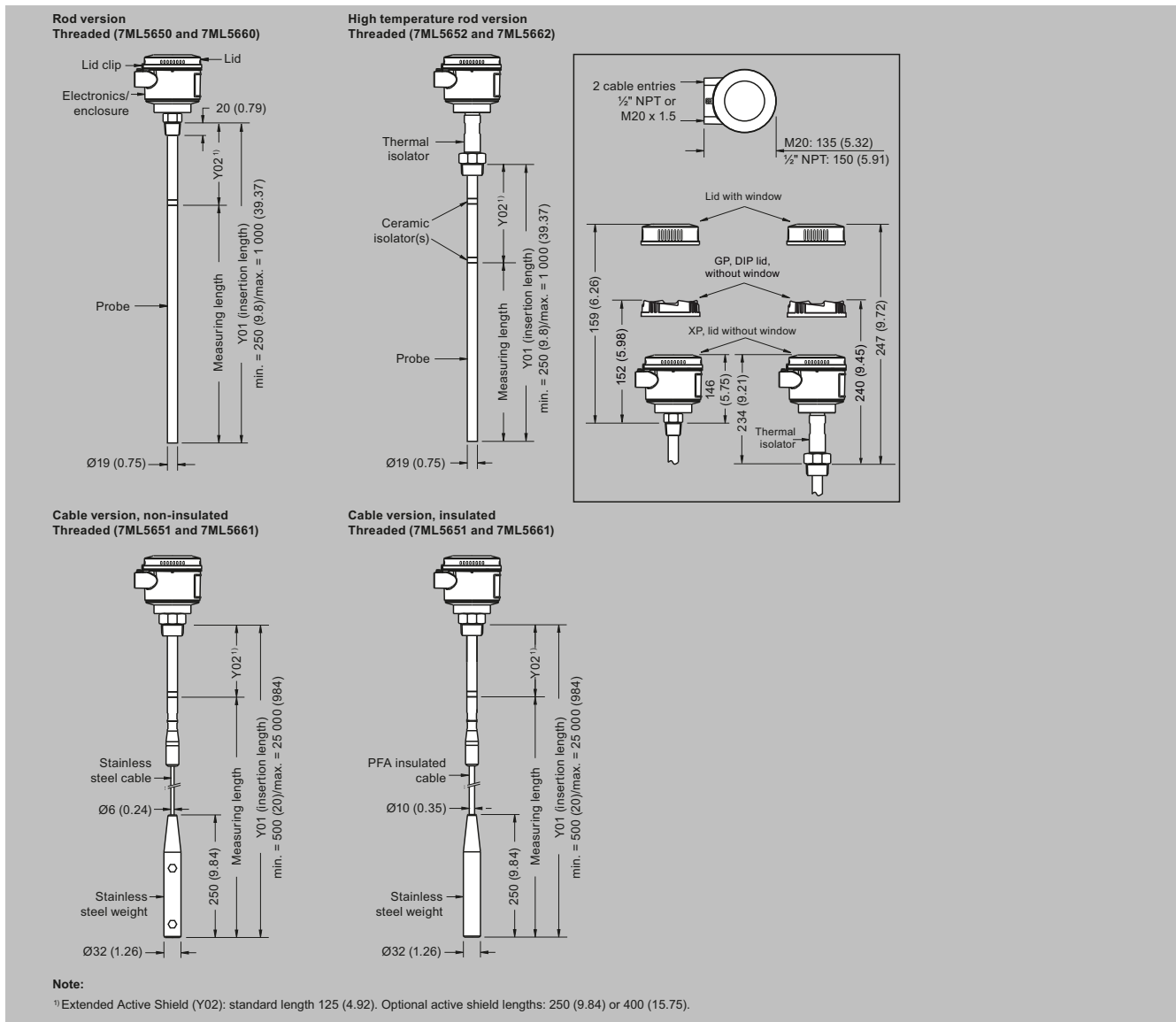

Pointek CLS300 threaded process connections, dimensions in mm (inch)

Pointek CLS300 - Standard

Dimensional drawings (continued)

**Rod version
Welded flange (7ML5650 and 7ML5660)**

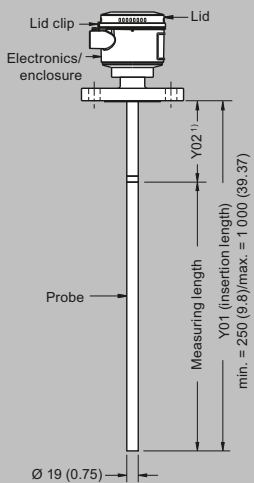

**High temperature rod version
Welded flange (7ML5652 and 7ML5662)**

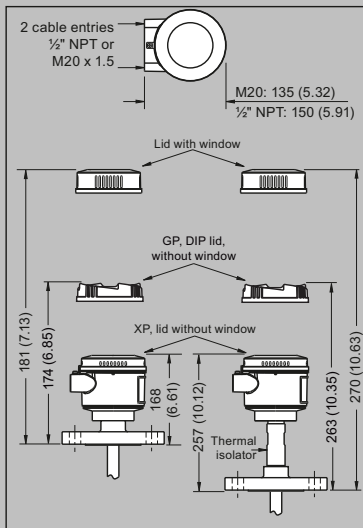
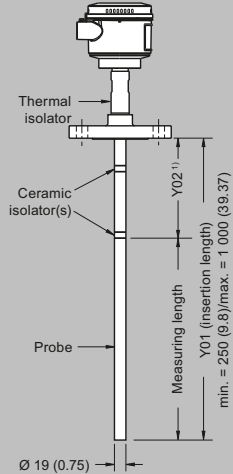

**Cable version, non-insulated
Welded flange (7ML5651 and 7ML5661)**

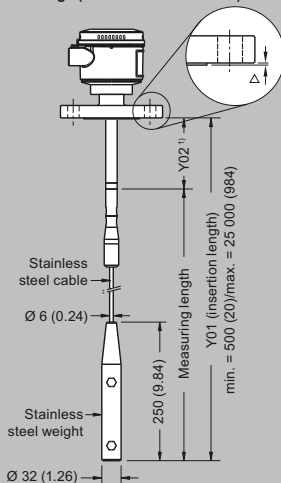

**Cable version, insulated
Welded flange (7ML5651 and 7ML5661)**

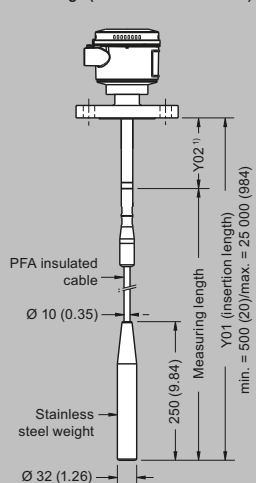

Flange Facing (raised face)	
Flange Class	Facing thickness
△ ASME 150/300	2 (0.08)
△ ASME 600/900	7 (0.28)
△ PN16/40	2 (0.08)

Note:

¹⁾ Extended Active Shield (Y02): standard length 105 (4.13). Optional active shield lengths: 230 (9.06) or 380 (14.96). Insertion length does not include any raised face/gasket face dimension (see Flange Facing Table above)

Pointek CLS300 flanged process connections, dimensions in mm (inch)

Circuit diagrams

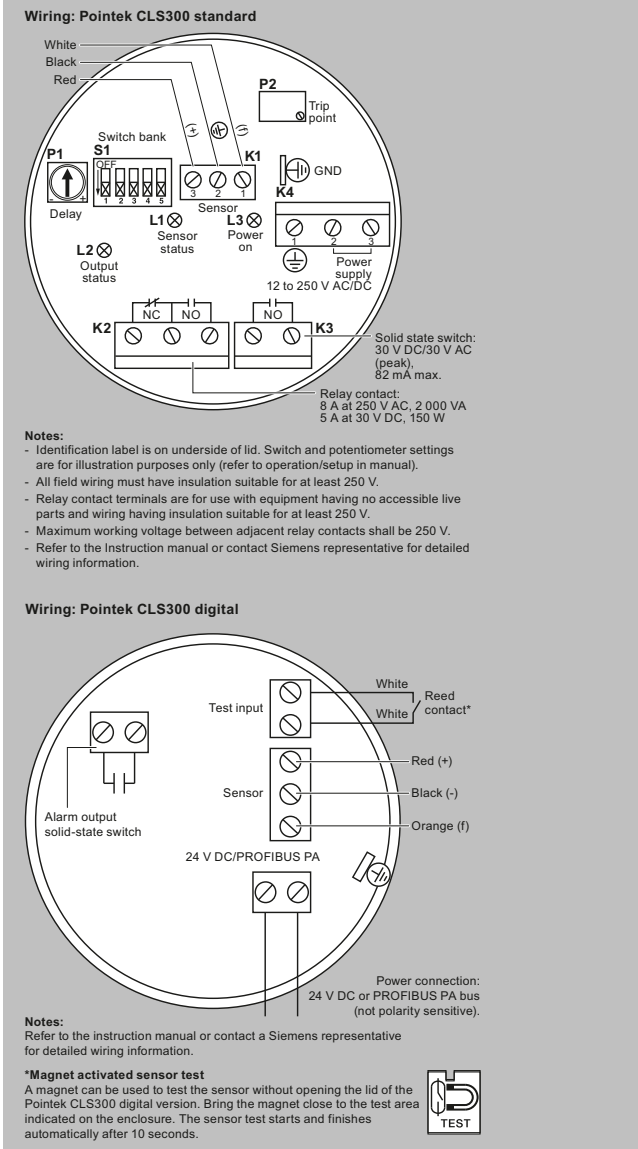

Pointek CLS300 connections

Overview



Pointek CLS300 (digital version) is an inverse frequency shift capacitance level and material detection switch with optional rod/cable choices and configurable output. It is ideal for detecting liquids, solids, slurries, foam, and interfaces in demanding conditions where high pressure and temperatures are present and has the ability to tune out buildup on the probe. The digital version includes PROFIBUS PA, an LCD display, and advanced diagnostic features.

Benefits

- Active-Shield technology so measurement is unaffected by material buildup or nozzle interference in active shield section
- Performs in extremely abrasive conditions because of solid rod construction
- Push-button calibration, full-function diagnostics
- High sensitivity allows installation in a wide range of liquids, solids or slurry applications
- Integral LCD display allows for easy menu-driven setup
- PROFIBUS PA communication (SIMATIC PDM compatible)

Application

Pointek CLS300 digital version provides an integral LCD display for stand-alone use, with PROFIBUS PA communication (Profile version 3.0, Class B) when required. Solid-state switch alarm is standard.

The robust design of CLS300 makes it specifically applicable for heavy solids applications where abrasive materials occur as in the mining industry.

The fully potted electronics are unaffected by condensation, dust or vibration.

Wetted parts are made of stainless steel with a PFA shield for high chemical resistance, and of ceramic and stainless steel for high temperature version. Materials with low or high dielectric constants can be accurately detected. The unique Active Shield suppresses interference from material buildup or long installation nozzles.

The unique modular design of the Pointek CLS300 provides a wide range of configurations, process connections, extensions and approvals to meet the temperature and pressure requirements of specific applications. The modular design makes ordering easier and reduces stocking requirements. A wide range of probe configurations are available, including rod and cable versions.

- Key Applications: liquids, slurries, bulk solids, relatively high pressure and temperature, hazardous areas, milling and mining applications

Pointek CLS300 - Digital

Configuration

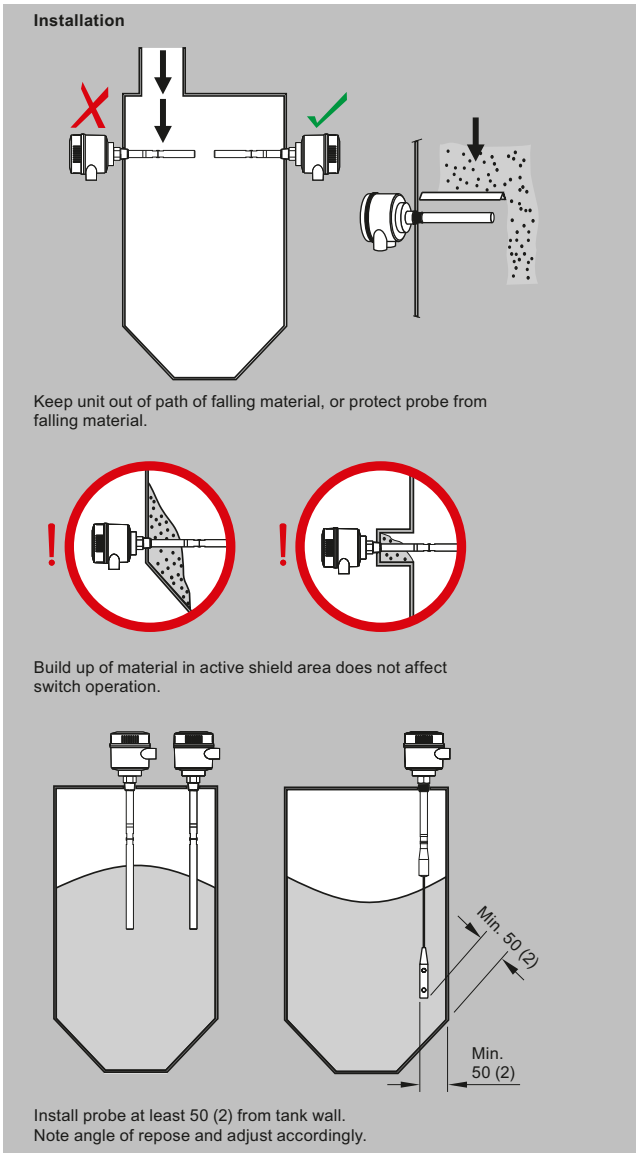

Pointek CLS300 installation, dimensions in mm (inch)

Selection and ordering data

	Article No.	
Pointek CLS300 RF Capacitance point level switch, digital, rod design. Detects level and interface in aggressive liquids, solids, slurries, and foam. Adjustable, 1 m (3.28 ft), insertion, adaptable sensitivity, and active shield to tune out build-up on probe. With display and digital communications.	7ML5660-●●●●●-●●●●●	
Click on the Article No. for the online configuration in the PIA Life Cycle Portal.		
Process connection		
<u>Threaded, 316L stainless steel</u>		
¾" NPT [(Taper), ASME B1.20.1]	0	A
1" NPT [(Taper), ASME B1.20.1]	0	B
1¼" NPT [(Taper), ASME B1.20.1]	0	C
1½" NPT [(Taper), ASME B1.20.1]	0	D
R ¾" [(BSPT), EN 10226/PT (JIS-T), JIS B 0203]	1	A
R 1" [(BSPT), EN 10226/PT (JIS-T), JIS B 0203]	1	B
R 1½" [(BSPT), EN 10226/PT (JIS-T), JIS B 0203]	1	D
G ¾" [(BSPP), EN ISO 228-1/PF (JIS-P), JIS B 0202]	3	A
G 1" [(BSPP), EN ISO 228-1/PF (JIS-P), JIS B 0202]	3	B
G 1½" [(BSPP), EN ISO 228-1/PF (JIS-P), JIS B 0202]	3	D
<u>Welded flange, 316L stainless steel, raised face</u>		
1" ASME, 150 lb	5	A
1" ASME, 300 lb	5	B
1" ASME, 600 lb	5	C
1½" ASME, 150 lb	5	D
1½" ASME, 300 lb	5	E
1½" ASME, 600 lb	5	F
2" ASME, 150 lb	5	G
2" ASME, 300 lb	5	H
2" ASME, 600 lb	5	J
3" ASME, 150 lb	5	K
3" ASME, 300 lb	5	L
3" ASME, 600 lb	5	M
4" ASME, 150 lb	5	N
4" ASME, 300 lb	5	P
4" ASME, 600 lb	5	Q
<u>Welded flange, 316L stainless steel, Type A flat faced</u>		
DN 25, PN 16	6	A
DN 25, PN 40	6	B
DN 40, PN 16	6	C
DN 40, PN 40	6	D
DN 50, PN 16	6	E
DN 50, PN 40	6	F
DN 80, PN 16	6	G
DN 80, PN 40	6	H
DN 100, PN 16	6	J
DN 100, PN 40 (Note: Flange bolting patterns and facings dimensionally correspond to the applicable ASME B16.5 or EN 1092-1 standard.)	6	K
Probe length (length from flange face) (threaded lengths include process thread)		
<u>Note: No Y01 needed in Order code for standard lengths</u>		
Standard version, rod 350 mm (13.78 inch)		A
Extended rod, length 500 mm (19.69 inch)		B
Extended rod, length 750 mm (29.53 inch)		C
Extended rod, length 1 000 mm (39.37 inch)		D
<u>Add Order code Y01 and plain text: "Insertion length ... mm"</u>		
Extended rod, factory adjusted length 250 ... 499 mm (9.8 ... 19.65 inch)		E
Extended rod, factory adjusted length 500 ... 749 mm (19.69 ... 29.49 inch)		F
Extended rod, factory adjusted length 750 ... 999 mm (29.53 ... 39.3 inch)		G

Pointek CLS300 - Digital

Selection and ordering data (continued)

	Article No.										
Pointek CLS300 RF Capacitance point level switch, digital, rod design. Detects level and interface in aggressive liquids, solids, slurries, and foam. Adjustable, 1 m (3.28 ft), insertion, adaptable sensitivity, and active shield to tune out build-up on probe. With display and digital communications.	7	M	L	5	6	6	0	-			
Thermal isolator											
Without thermal isolator							0				
With thermal isolator [for process connection temperatures over 85 °C (185 °F)]							1				
Wetted seals											
FKM								0			
FFKM [for process temperatures above -20 °C (-4 °F)]								1			
Probe material											
316L stainless steel with PFA lining and PEEK isolators									0		
Approvals											
Dust Ignition Proof: CE, UKCA, RCM, ATEX II 1/2 D Ex ia/tb [ia Da] IIIC TX Da/Db, UKEX II 1/2 D Ex ia/tb [ia Da] IIIC TX Da/Db											B
Intrinsically Safe ¹⁾ CE, RCM, CE, UKCA, RCM, ATEX II 1 G Ex ia IIC TX Ga, ATEX II 1/2 D Ex ia IIIC TX Da/Db UKEX II 1 G Ex ia IIC TX Ga, UKEX II 1/2 D Ex ia IIIC TX Da/Db											C
Flameproof Enclosure with IS Probe: CE, UKCA, RCM, ATEX II 1/2 G Ex ia/db [ia Ga] IIC TX Ga/Gb, ATEX II 1/2 D Ex ia/tb [ia Da] IIIC TX Da/Db UKEX II 1/2 G Ex ia/db [ia Ga] IIC TX Ga/Gb, UKEX II 1/2 D Ex ia/tb [ia Da] IIIC TX Da/Db											D
Dust Ignition Proof with IS Probe CSA/ FM Class II, III Div. 1 Gr. E, F, GT4											E
Intrinsically Safe CSA/ FM Class I, II, III Div. 1 Gr. A, B, C, D, E, F, G T4 or T6											F
Explosion Proof with IS Probe CSA/ FM Class I, II, III Div. 1 Gr. A, B, C, D, E, F, G T4											G
General Purpose CSA, FM											H
Ordinary Locations/General Purpose (Non-Ex): CSA, FM, CE, UKCA, RCM											J
Enclosure and Lid											
Aluminum epoxy coated											
2 x ½" NPT via adapter - cable inlet, IP65											A
2 x M20 x 1.5 cable inlet, IP65											B
2 x ½" NPT via adapter - cable inlet, IP68											C
2 x M20 x 1.5 cable inlet, IP68											D
Active shield length											
Standard length - (125 mm threaded, 105 mm flanged)											0
Extended shield - (250 mm threaded, 230 mm flanged) ²⁾											1
Extended shield - (400 mm threaded, 380 mm flanged) ³⁾											2

¹⁾ Barrier or Intrinsically Safe power supply required for Intrinsically Safe protection.

²⁾ Available with Probe version options B ... D, F, G only [≥ 500 mm (19.69 inch)].

³⁾ Available with Probe version options C, D, and G only [≥ 750 mm (29.53 inch)].

Selection and Ordering data	Order code
Further designs	
Please add "-Z" to Article No. and specify Order code(s).	
Total insertion length: enter the total insertion length in plain text description	Y01
Stainless steel tag [70 x 13 mm (2.75 x 0.5 inch)]: Measuring-point number/identification (max. 27 characters) specify in plain text	Y15
Manufacturer's test certificate: M to DIN 55350, Part 18 and to ISO 9000	C11
Material inspection Certificate Type 3.1 per EN 10204 INMETRO ¹⁾	C12 E34

Selection and Ordering data	Order code
Operating Instructions	
All literature is available to download for free, in a range of languages, at http://www.siemens.com/processinstrumentation/documentation .	
Accessories	See accessories following CLS300 Digital selection and ordering data.

¹⁾ Available only with Approvals options B and D.

Selection and ordering data (continued)

	Article No.										
Pointek CLS300 RF Capacitance point level switch, digital, cable design. Detects level and interface in aggressive liquids, solids, slurries, and foam. Cable extension options to 25 m (82.02 ft), adaptable sensitivity, with active shield to tune out build-up on probe. With display and digital communications.	7	M	L	5	6	6	1	-	6	6	6
Click on the Article No. for the online configuration in the PIA Life Cycle Portal.											
Process connection											
<u>Threaded, 316L stainless steel</u>											
1¼" NPT [(Taper), ASME B1.20.1]	0										C
1½" NPT [(Taper), ASME B1.20.1]	0										D
R 1½" [(BSPT), EN 10226/PT (JIS-T), JIS B 0203]	1										D
G 1½" [(BSPP), EN ISO 228-1/PF (JIS-P), JIS B 0202]	3										D
<u>Welded flange, 316L stainless steel, raised face</u>											
1½" ASME, 150 lb	5										D
1½" ASME, 300 lb	5										E
1½" ASME, 600 lb	5										F
2" ASME, 150 lb	5										G
2" ASME, 300 lb	5										H
2" ASME, 600 lb	5										J
3" ASME, 150 lb	5										K
3" ASME, 300 lb	5										L
3" ASME, 600 lb	5										M
4" ASME, 150 lb	5										N
4" ASME, 300 lb	5										P
4" ASME, 600 lb	5										Q
<u>Welded flange, 316L stainless steel, Type A flat faced</u>											
DN 40, PN 16	6										C
DN 40, PN 40	6										D
DN 50, PN 16	6										E
DN 50, PN 40	6										F
DN 80, PN 16	6										G
DN 80, PN 40	6										H
DN 100, PN 16	6										J
DN 100, PN 40 (Note: Flange bolting patterns and facings dimensionally correspond to the applicable ASME B16.5 or EN 1092-1 standard.)	6										K
Probe length (length from flange face) (threaded lengths include process thread)											
<u>Note: No Y01 needed in Order code for standard lengths</u>											
Extended cable, 3 000 mm (118.11 inch), length can be shortened by customer											A
Extended cable, 6 000 mm (236.22 inch), length can be shortened by customer											B
<u>Add Order code Y01 and plain text: "Insertion length ... mm"</u>											
Extended cable, 500 ... 1 000 mm (19.69 ... 39.37 inch) ³⁾											E
Extended cable, 1 001 ... 5 000 mm (39.41 ... 196.85 inch)											F
Extended cable, 5 001 ... 10 000 mm (196.89 ... 393.70 inch)											G
Extended cable, 10 001 ... 15 000 mm (393.74 ... 590.55 inch)											H
Extended cable, 15 001 ... 20 000 mm (590.59 ... 787.40 inch)											J
Extended cable, 20 001 ... 25 000 mm (787.44 ... 984.25 inch)											K
Thermal isolator											
Without thermal isolator									0		
With thermal isolator [for process connection temperatures over 85 °C (185 °F)]									1		
Wetted seals											
FKM									0		
FFKM [for process temperatures above -20 °C (-4 °F)]									1		
Probe material											
Bare 316L stainless steel cable, PEEK isolators and 316L stainless steel cable weight											0
PFA coated cable, PEEK isolators and 316L stainless steel cable weight											1

Pointek CLS300 - Digital

Selection and ordering data (continued)

Article No.											
Pointek CLS300 RF Capacitance point level switch, digital, cable design. Detects level and interface in aggressive liquids, solids, slurries, and foam. Cable extension options to 25 m (82.02 ft), adaptable sensitivity, with active shield to tune out build-up on probe. With display and digital communications.	7ML5661-	●	●	●	●	●	-	●	●	●	●
Approvals											
Dust Ignition Proof: CE, UKCA, RCM, ATEX II 1/2 D Ex ia/tb [ia Da] IIIC TX Da/Db, UKEX II 1/2 D Ex ia/tb [ia Da] IIIC TX Da/Db											B
Intrinsically Safe ¹⁾ CE, UKCA, RCM, ATEX II 1 G Ex ia IIIC TX Ga, ATEX II 1/2 D Ex ia IIIC TX Da/Db, UKEX II 1 G Ex ia IIIC TX Ga, UKEX II 1/2 D Ex ia IIIC TX Da/Db											C
Flameproof Enclosure with IS Probe: CE, UKCA, RCM, ATEX II 1/2 G Ex ia/db [ia Ga] IIC TX Ga/Gb, ATEX II 1/2 D Ex ia/tb [ia Da] IIIC TX Da/Db, UKEX II 1/2 G Ex ia/db [ia Ga] IIC TX Ga/Gb, UKEX II 1/2 D Ex ia/tb [ia Da] IIIC TX Da/Db											D
Dust Ignition Proof with IS Probe CSA/ FM Class II, III Div. 1 Gr. E, F, GT4											E
Intrinsically Safe CSA/ FM Class I, II, III Div. 1 Gr. A, B, C, D, E, F, G T4 or T6											F
Explosion Proof with IS Probe CSA/ FM Class I, II, III Div. 1 Gr. A, B, C, D, E, F, G T4											G
General Purpose CSA, FM											H
Ordinary Locations/General Purpose (Non-Ex): CSA, FM, CE, UKCA, RCM											J
Enclosure and Lid											
Aluminum epoxy coated											
2 x 1/2" NPT via adapter - cable inlet, IP65											A
2 x M20 x 1.5 cable inlet, IP65											B
2 x 1/2" NPT via adapter - cable inlet, IP68											C
2 x M20 x 1.5 cable inlet, IP68											D
Active shield length											
Standard length - (125 mm threaded, 105 mm flanged)											0
Extended shield - (250 mm threaded, 230 mm flanged) ²⁾											1
Extended shield - (400 mm threaded, 380 mm flanged) ²⁾											2

¹⁾ Barrier or Intrinsically Safe power supply required for Intrinsically Safe protection.

²⁾ Available with Probe version options A, B, F ... K, only [$\geq 1\ 000$ mm (39.7 inch)].

³⁾ Not available with Active shield option 1.

Selection and Ordering data	Order code
Further designs	
Please add "-Z" to Article No. and specify Order code(s).	
Total insertion length: enter the total insertion length in plain text description	Y01
Stainless steel tag [70 x 13 mm (2.75 x 0.5 inch)]: Measuring-point number/identification (max. 27 characters) specify in plain text	Y15
Manufacturer's test certificate: M to DIN 55350, Part 18 and to ISO 9000	C11
Material inspection Certificate Type 3.1 per EN 10204 INMETRO ¹⁾	C12 E34

Selection and Ordering data	Order code
Operating Instructions	
All literature is available to download for free, in a range of languages, at http://www.siemens.com/processinstrumentation/documentation .	
Accessories	See accessories following CLS300 Digital selection and ordering data.

¹⁾ Available only with Approvals options B and D.

Selection and ordering data (continued)

	Article No.	
Pointek CLS300 RF Capacitance point level switch, digital, high temperature design. Detects level and interface in aggressive liquids, solids, slurries, and foam. Adjustable, 1 m (3.28 ft), insertion, adaptable sensitivity, with active shield to tune out build-up on probe. With display and digital communications.	7ML5662-	● ● ● 0 ● - ● ● ● ● ●
Click on the Article No. for the online configuration in the PIA Life Cycle Portal.		
Process connection		
<u>Threaded, 316L stainless steel</u>		
¾" NPT [(Taper), ASME B1.20.1]	0	A
1" NPT [(Taper), ASME B1.20.1]	0	B
1¼" NPT [(Taper), ASME B1.20.1]	0	C
1½" NPT [(Taper), ASME B1.20.1]	0	D
R ¾" [(BSPT), EN 10226/PT (JIS-T), JIS B 0203]	1	A
R 1" [(BSPT), EN 10226/PT (JIS-T), JIS B 0203]	1	B
R 1½" [(BSPT), EN 10226/PT (JIS-T), JIS B 0203]	1	D
G ¾" [(BSPP), EN ISO 228-1/PF (JIS-P), JIS B 0202]	3	A
G 1" [(BSPP), EN ISO 228-1/PF (JIS-P), JIS B 0202]	3	B
G 1½" [(BSPP), EN ISO 228-1/PF (JIS-P), JIS B 0202]	3	D
<u>Welded flange, 316L stainless steel, raised face</u>		
1" ASME, 150 lb	5	A
1" ASME, 300 lb	5	B
1" ASME, 600 lb	5	C
1½" ASME, 150 lb	5	D
1½" ASME, 300 lb	5	E
1½" ASME, 600 lb	5	F
2" ASME, 150 lb	5	G
2" ASME, 300 lb	5	H
2" ASME, 600 lb	5	J
3" ASME, 150 lb	5	K
3" ASME, 300 lb	5	L
3" ASME, 600 lb	5	M
4" ASME, 150 lb	5	N
4" ASME, 300 lb	5	P
4" ASME, 600 lb	5	Q
<u>Welded flange, 316L stainless steel, Type A flat faced</u>		
DN 25, PN 16	6	A
DN 25, PN 40	6	B
DN 40, PN 16	6	C
DN 40, PN 40	6	D
DN 50, PN 16	6	E
DN 50, PN 40	6	F
DN 80, PN 16	6	G
DN 80, PN 40	6	H
DN 100, PN 16	6	J
DN 100, PN 40 (Note: Flange bolting patterns and facings dimensionally correspond to the applicable ASME B16.5 or EN 1092-1 standard.)	6	K
Probe length (length from flange face) (threaded lengths include process thread)		
<u>Note: No Y01 needed in Order code for standard lengths</u>		
Standard version rod, 350 mm (13.78 inch)		A
Extended rod, length 500 mm (19.69 inch)		B
Extended rod, length 750 mm (29.53 inch)		C
Extended rod, length 1 000 mm (39.37 inch)		D
<u>Add Order code Y01 and plain text: "Insertion length ... mm"</u>		
Extended rod, factory adjusted length 250 ... 499 mm (9.8 ... 19.65 inch)		E
Extended rod, factory adjusted length 500 ... 749 mm (19.69 ... 29.49 inch)		F
Extended rod, factory adjusted length 750 ... 999 mm (29.53 ... 39.3 inch)		G
Wetted seals		
Graphite		0

Pointek CLS300 - Digital

Selection and ordering data (continued)

	Article No.
Pointek CLS300 RF Capacitance point level switch, digital, high temperature design. Detects level and interface in aggressive liquids, solids, slurries, and foam. Adjustable, 1 m (3.28 ft), insertion, adaptable sensitivity, with active shield to tune out build-up on probe. With display and digital communications.	7ML562- ● ● ● 0 ● - ● ● ● ● ●
Probe material	
316L stainless steel with ceramic (ZrO ₂)isolators	0
Approvals	
Dust Ignition Proof: CE, UKCA, RCM, ATEX II 1/2 D Ex ia/tb [ia Da] IIIC TX Da/Db, UKEX II 1/2 D Ex ia/tb [ia Da] IIIC TX Da/Db	B
Intrinsically Safe ¹⁾ CE, UKCA, RCM, ATEX II 1 G Ex ia IIC TX Ga, ATEX II 1/2 D Ex ia IIIC TX Da/Db UKEX II 1 G Ex ia IIC TX Ga, UKEX II 1/2 D Ex ia IIIC TX Da/Db	C
Flameproof Enclosure with IS Probe: CE, UKCA, RCM, ATEX II 1/2 G Ex ia/db [ia Ga] IIC TX Ga/Gb, ATEX II 1/2 D Ex ia/tb [ia Da] IIIC TX Da/Db UKEX II 1/2 G Ex ia/db [ia Ga] IIC TX Ga/Gb, UKEX II 1/2 D Ex ia/tb [ia Da] IIIC TX Da/Db	D
Dust Ignition Proof with IS Probe CSA/ FM Class II, III Div. 1 Gr. E, F, GT4	E
Intrinsically Safe CSA/ FM Class I, II, III Div. 1 Gr. A, B, C, D, E, F, G T4 or T6	F
Explosion Proof with IS Probe CSA/ FM Class I, II, III Div. 1 Gr. A, B, C, D, E, F, G T4	G
General Purpose CSA, FM	H
Ordinary Locations/General Purpose (Non-Ex): CSA, FM, CE, UKCA, RCM	J
Enclosure and Lid	
Aluminum epoxy coated	
2 x ½" NPT via adapter - cable inlet, IP65	A
2 x M20 x 1.5 cable inlet, IP65	B
2 x ½" NPT via adapter - cable inlet, IP68	C
2 x M20 x 1.5 cable inlet, IP68	D
Active shield length	
Standard length - (125 mm threaded, 105 mm flanged)	0
Extended shield - (250 mm threaded, 230 mm flanged) ²⁾	1
Extended shield - (400 mm threaded, 380 mm flanged) ³⁾	2

¹⁾ Barrier or Intrinsically Safe power supply required for Intrinsically Safe protection.

²⁾ Available with Probe version options B ... D, F, G only [≥ 500 mm (19.69 inch)].

³⁾ Available with Probe version options C, D, and G only [≥ 750 mm (29.53 inch)].

Selection and Ordering data	Order code
Further designs	
Please add "-Z" to Article No. and specify Order code(s).	
Total insertion length: enter the total insertion length in plain text description	Y01
Stainless steel tag [70 x 13 mm (2.75 x 0.5 inch)]: Measuring-point number/identification (max. 27 characters) specify in plain text	Y15
Manufacturer's test certificate: M to DIN 55350, Part 18 and to ISO 9000	C11
Material Inspection Certificate Type 3.1 per EN 10204 INMETRO ¹⁾	C12 E34
Operating Instructions	
All literature is available to download for free, in a range of languages, at http://www.siemens.com/processinstrumentation/documentation .	
Accessories	See accessories following CLS300 Digital selection and ordering data.

¹⁾ Available only with Approvals options B and D.

Selection and Ordering data	Article No.
Accessories	
One metallic cable gland M20 x 1.5, -40 ... +80 °C (-40 ... +176 °F) with integrated shield connection (available for PROFIBUS PA)	7ML1930-1AQ
General Purpose	
½" NPT General Purpose Cable Entry IP68/IP69K NEMA 6, -40 ... +80 °C (-40 ... +176 °F), Dust Ignition Proof, cable size 6 ... 12 mm (0.236 ... 0.472 inch)	7ML1830-1JA
M20 x 1.5 General Purpose Cable Entry IP68/IP69K NEMA 6, -40 ... +80 °C (-40 ... +176 °F), Dust Ignition Proof, cable size 7 ... 12 mm (0.275 ... 0.472 inch)	7ML1830-1JC

Selection and ordering data (continued)

Selection and Ordering data	Article No.
Hazardous Locations	
½" NPT EMC rated Cable Gland: Dust Ignition Proof, Flameproof Exd, and Increased Safety ATEX and UKEX II 2 GD ExtD A21 (Zone 1, Zone 2, Zone 21, Zone 22, and in Gas Groups IIA, IIB and IIC) -60 ... +80 °C IP66, IP67, IP68, NEMA4X, cable sizes 5.5 ... 12 mm (0.216 ... 0.472 inch)	7ML1830-1JB
M20 EMC rated Cable Gland: Dust Ignition Proof, Flameproof Exd, and Increased Safety ATEX and UKEX II 2 GD ExtD A21 (Zone 1, Zone 2, Zone 21, Zone 22, and in Gas Groups IIA, IIB and IIC) -60 ... +80 °C IP66, IP67, IP68, NEMA4X, cable sizes 5.5 ... 12 mm (0.216 ... 0.472 inch)	7ML1830-1JD
<i>Blind threaded flanges are available. Customers interested in a custom designed device should consult a local sales person. For more information, please visit http://www.automation.siemens.com/aspa_app.</i>	
Pointek Specials	See page 4/60

Pointek Specials ¹⁾	Article No.
CLS100 Polycarbonate Lid and Gasket, FKM	
Kit, lid and gasket, CLS100 enclosure version	A5E01163671
CLS100 Miscellaneous Parts	
Custom length of cable is available only for 7ML5501-xxx1x and 7ML5501-xxx5x ²⁾	
CLS200 Gasket (IP65), Synprene	
Spare gasket, enclosure version (IP65 versions only)	A5E01163672
CLS200 Gasket (IP68), Silicone	
Spare gasket, enclosure version (IP68 versions)	A5E01163673
CLS200/CLS300/LC300 Blind Lid	
Spare aluminum blind lid (for standard versions only)	A5E01163674
CLS200/CLS300 Lid with window	
Spare aluminum lid with window	A5E01163676
CLS200 Sensor Kit for cable units	
Kit, sensor for cable units, PPS, standard, FKM	A5E01163677
Kit, sensor for cable units, PPS, digital, FKM	A5E01163678
Kit, sensor for cable units, PPS, standard, FFKM	A5E01163679
Kit, sensor for cable units, PPS, digital, FFKM	A5E01163680
Kit, sensor for cable units, PVDF, standard, FKM	A5E01163681
Kit, sensor for cable units, PVDF, digital, FKM	A5E01163682
Kit, sensor for cable units, PVDF, standard, FFKM	A5E01163683
Kit, sensor for cable units, PVDF, digital, FFKM	A5E01163684
CLS200 Mounting Bracket, 316L stainless steel	
Spare mounting bracket, mounting hole 27 mm (1 inch)	A5E01163685
CLS200 PROFIBUS Connector (IP65)	
Spare, PROFIBUS connector (IP65 versions only)	A5E01163686
CLS200 Miscellaneous Parts	
CLS200 with FFKM O-rings (any version) ²⁾	
CLS200 Electronics	
Test magnet, digital version	7ML1830-1JE
Amplifier/power supply kit, standard version	A5E03251681
Amplifier/power supply, digital version	7ML1830-1JF
LCD display, digital version	7ML1830-1JK
CLS300 Cable Extensions, 316L stainless steel	
Kit, stainless steel cable extension, 1 m, adjustable by customer	A5E01163688
Kit, stainless steel cable extension, 3 m, adjustable by customer	A5E01163689
Kit, stainless steel cable extension, 5 m, adjustable by customer	A5E01163690
Kit, stainless steel cable extension, 10 m, adjustable by customer	A5E01163691
Kit, stainless steel cable extension, 15 m, adjustable by customer	A5E01163693
Kit, stainless steel cable extension, 20 m, adjustable by customer	A5E01163695

Pointek Specials ¹⁾	Article No.
CLS300 Cable Extensions, 316 stainless steel with PFA coating	
Kit, PFA cable extension, 1 m, adjustable by customer	A5E01163697
Kit, PFA cable extension, 3 m, adjustable by customer	A5E01163698
Kit, PFA cable extension, 5 m, adjustable by customer	A5E01163699
Kit, PFA cable extension, 10 m, adjustable by customer	A5E01163700
Kit, PFA cable extension, 15 m, adjustable by customer	A5E01163701
Kit, PFA cable extension, 20 m, adjustable by customer	A5E01163702
CLS300 Rod Kits, 316L stainless steel	
Kit, stainless steel rod 180 mm (7.09 inch) to be used with CLS300 units only (with standard active shield). Insertion length after installation is 350 mm (13.78 inch).	A5E01163719
Kit, stainless steel rod 330 mm (12.99 inch) to be used with CLS300 units only (with standard active shield). Insertion length after installation is 500 mm (19.69 inch).	A5E01163720
Kit, stainless steel rod 580 mm (22.83 inch) to be used with CLS300 units only (with standard active shield). Insertion length after installation is 750 mm (29.53 inch).	A5E01163721
Kit, stainless steel rod 830 mm (32.68 inch) to be used with CLS300 units only (with standard active shield). Insertion length after installation is 1 000 mm (39.37 inch).	A5E01163722
Kit, stainless steel rod 1330 mm (52.36 inch) to be used with CLS300 units only (with standard active shield). Insertion length after installation is 1 500 mm (59.06 inch). ²⁾	
Kit, stainless steel rod 1830 mm (72.05 inch) to be used with CLS300 units only (with standard active shield). Insertion length after installation is 2 000 mm (78.74 inch). ²⁾	
Kit, stainless steel rod customized length up to 1 m ²⁾	
Kit, stainless steel rod customized length up to 2 m ²⁾	
CLS300 Electronics Kits with drivers (for rod or cable versions)	
Kit, electronics with driver, standard CLS300. To be used in cable versions with length greater than 5 m. ³⁾⁴⁾	A5E01163723
Kit, electronics with driver, digital CLS300. To be used in cable versions with length greater than 5 m. ³⁾⁴⁾	A5E01163725
CLS300 Electronics Kits with drivers (for cable versions)	
Kit, electronics with driver, standard CLS300. To be used in cable versions with length greater than 5 m. ³⁾⁴⁾	A5E01163724
Kit, electronics with driver, digital CLS300. To be used in cable versions with length greater than 5 m. ³⁾⁴⁾	A5E01163726
CLS300 Electronics	
Test magnet, digital version	7ML1830-1JE
Amplifier/power supply kit, standard version	A5E03251683
Amplifier/power supply, digital version	7ML1830-1JF
LCD display, digital version	7ML1830-1JK
CLS300 Weight Kit, 316L stainless steel	
Kit, spare stainless steel weight. To be used in any cable version of CLS300.	A5E01163727

1) Special flange sizes and facings are available. Please consult a local sales person for details.

2) Please consult a local sales person for part number and pricing

3) For General Purpose approvals only

4) To maintain approvals, qualified trained Siemens personnel required for part replacement

Customers interested in a custom designed device should consult a local sales person. For more information, please visit http://www.automation.siemens.com/aspa_app.

Pointek CLS300 - Digital

Technical specifications

Pointek CLS300 Digital	
Mode of operation	
Measuring principle	Inverse frequency shift capacitive level detection
Input	
Measured variable	Change in picroFarad (pF)
Output	
Solid-state output	
• Output	Galvanically isolated
• Protection	Against reversed polarity (bipolar)
• Max. switching voltage	<ul style="list-style-type: none"> • 30 V (DC) • 30 V peak (AC)
• Max. load current	82 mA
• Voltage drop	< 1 V, typical at 50 mA
• Time delay (pre or post switching)	Programmable by user (0 ... 100 s)
Fail-safe mode	Min. or max.
Connection	Removable terminal block
Accuracy	
Resolution	
• Min. sensitivity (pF)	1 % change in actual capacitance
• Max. temperature error	0.2 % of actual capacitance value
Rated operating conditions¹⁾	
Installation conditions	
• Location	Indoor/outdoor
Ambient conditions	
• Ambient temperature	-40 ... +85 °C (-40 ... +185 °F) ²⁾
• Storage temperature	-40 ... +85 °C (-40 ... +185 °F)
Medium conditions	
• Relative dielectric constant ϵ_r	Liquids, bulk solids, slurries, interfaces, and applications with viscous materials
• Process temperature	Min. 1.5
- Rod/Cable version	-40 ... +200 °C (-40 ... +392 °F) ²⁾
- High Temperature version	-40 ... +400 °C (-40 ... +752 °F)
• Process pressure ³⁾	-1 ... +35 bar g (-14.6 ... +511 psi g)
Design	
Material (enclosure)	Powder-coated aluminum with gasket
Degree of protection	Standard: Type 4/NEMA 4/IP65 Optional: Type 4/NEMA 4/IP68
Cable inlet	2 x M20 x 1.5 thread (option: 2 x 1/2" NPT conduit entry including 1 plugged entry)
Controls and displays	
Local display	LCD
Configuration	<ul style="list-style-type: none"> • Locally, using 3 button keypad (for standalone operation) • Remotely, using SIMATIC PDM (for installation on a network)

Pointek CLS300 Digital	
Power supply	
Bus voltage (at process connection)	<ul style="list-style-type: none"> • Standard: 12 ... 30 V DC • Intrinsically Safe: 12 ... 24 V DC
Current consumption	12.5 mA
Certificates and approvals	
General Purpose	
Dust Ignition Proof	CSA, FM, CE, UKCA, RCM ATEX II 1/2 D, 2 D IP6X T100 °C UKEX II 1/2 D Ex ia/tb [ia Da] IIC TX Da/Db
Flameproof Enclosure With IS Probe	ATEX II 1/2 G EEx d[ia] IIC T6 ... T4 ATEX II 1/2 D T100 °C UKEX II 1/2 G Ex ia/db [ia Ga] IIC TX Ga/Gb UKEX II 1/2 D Ex ia/tb [ia Da] IIC TX Da/Db
Dust Ignition Proof With IS Probe	CSA/FM Class II, Div. 1, Groups E, F, G CSA/FM Class III T4
Intrinsically Safe ⁴⁾	ATEX II 1 G EEx ia IIC T6 ... T4 ATEX II 1/2 D, 2 D IP6X T100 °C UKEX II 1 G Ex ia IIC TX Ga UKEX II 1/2 D Ex ia IIC TX Da/Db CSA/FM Class I, Div. 1, Groups A, B, C, D CSA/FM Class II, Div. 1, Groups E, F, G CSA/FM Class III T4
Non-incendive	CSA/FM Class I, Div. 2, Groups A, B, C, D CSA/FM Class II, Div. 2, Groups F, G CSA/FM Class III T4 or T6
Explosion Proof with IS Probe	CSA/FM Class I, Div. 1, Groups A, B, C, D CSA/FM Class II, Div. 1, Groups E, F, G CSA/FM Class III T4
Marine	Lloyds Register of Shipping, Categories ENV1, ENV2, and ENV5
Others	Pattern Approval (China)
Communication	
PROFIBUS PA (IEC 61158 CPF3 CP3/2) Bus physical layer: IEC 61158-2 MBP-(IS) Device profile: PROFIBUS PA profile for Process Control Devices Version 3.0, Class B FISCO field device	

- 1) When operation is in areas classified as hazardous, observe restrictions according to relevant certificate. See also CLS300 pressure/temperature curves.
- 2) Thermal isolator is used if process connection temperature exceeds 85 °C (185 °F)
- 3) Pressure rating of process seal is temperature dependent. See also CLS300 pressure/temperature curves.
- 4) Barrier or Intrinsically Safe power supply required for Intrinsically Safe protection

Technical specifications (continued)

Design: Probe			
	Rod version	High Temperature version	Cable version
Length	Min. 250 mm (9.8 inch), max. 1 000 mm (40 inch)	Min. 250 mm (9.8 inch), max. 1 000 mm (40 inch)	Min. 1 000 mm (40 inch), max. 25 000 mm (984 inch)
Sensor wetted parts	PFA (no insulation on active probe), 316L stainless steel, PEEK isolators	Ceramic (ZrO ₂ ¹⁾) isolators (no insulation on active probe), 316L stainless steel	316 stainless steel, optional PFA, PEEK isolators
O-ring seal material	FKM (optional FFKM) ²⁾	Graphite ²⁾	FKM (optional FFKM) ²⁾
Thermal isolator	Optional	Standard	Optional
Extension	User selectable length	User selectable length	User selectable cable length

¹⁾ Zirconium Oxide

²⁾ For caustic materials, consult a local sales person for alternative O-rings. For more information, please visit http://www.automation.siemens.com/aspa_app.

Pointek CLS300 - Digital

Characteristic curves

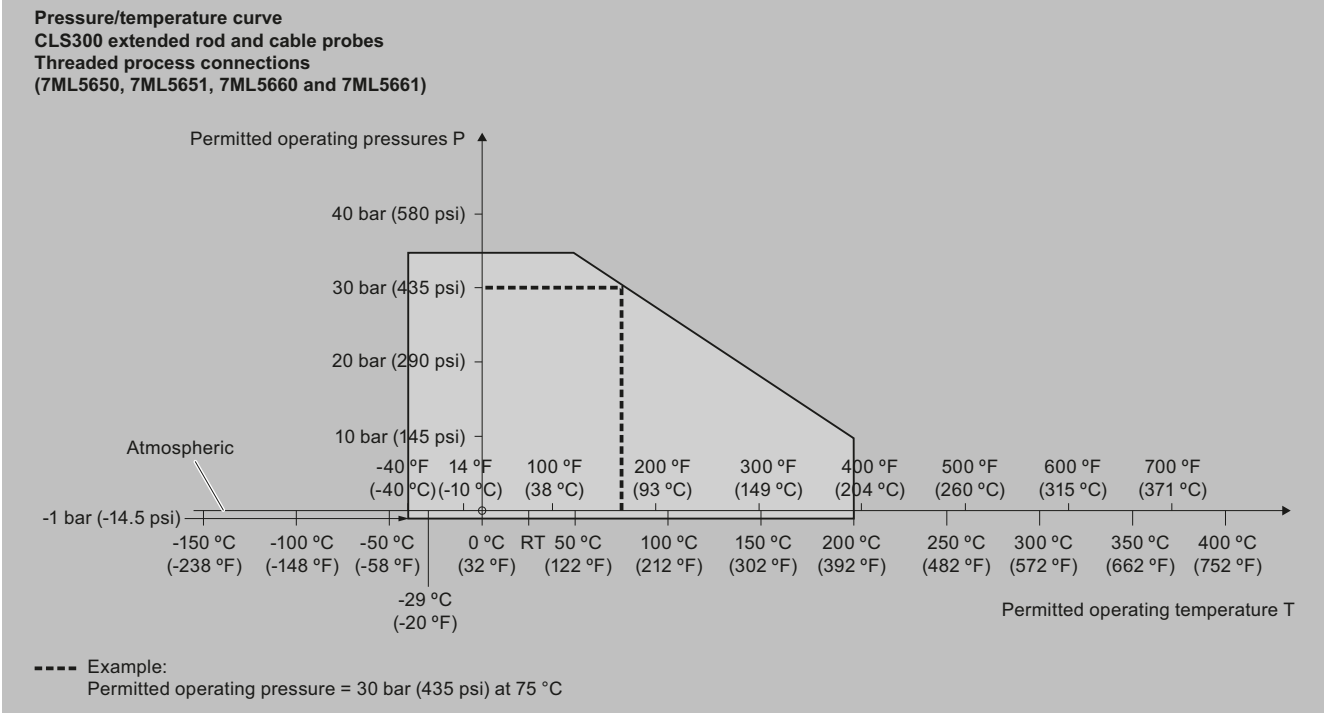

Pointek CLS300 process pressure/temperature derating curves (7ML5650, 7ML5651, 7ML5660 and 7ML5661)

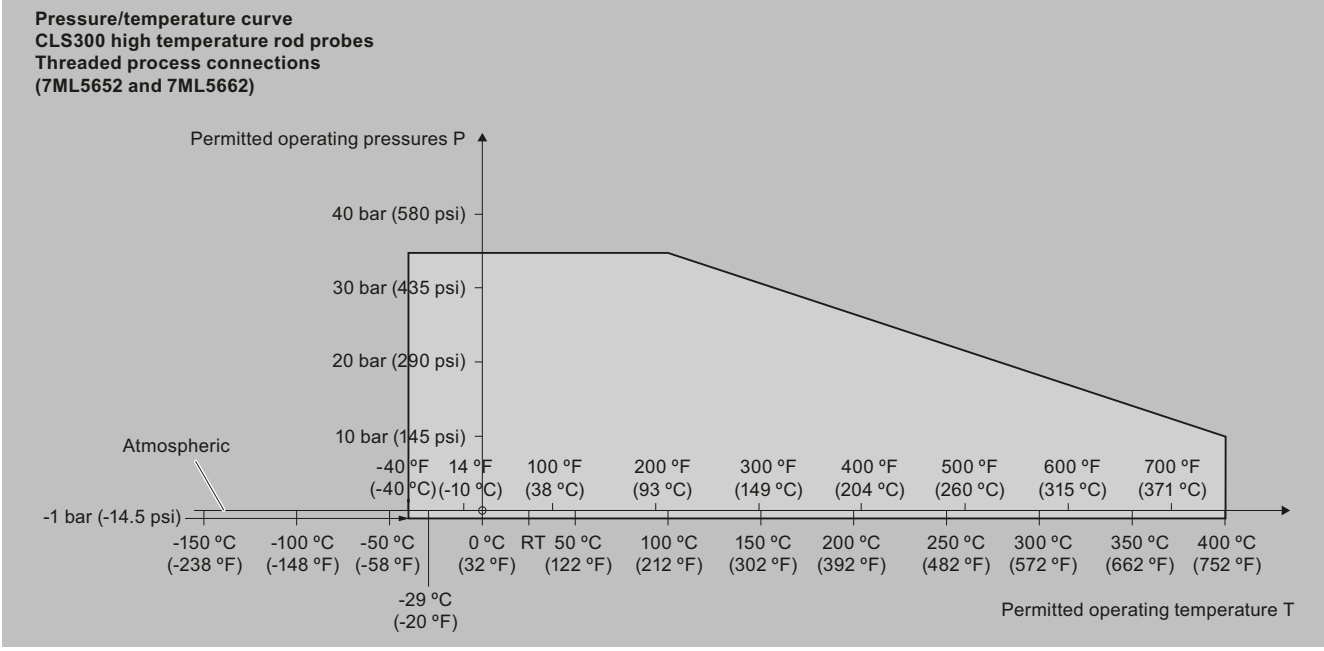

Pointek CLS300 process pressure/temperature derating curves (7ML5652 and 7ML5662)

Characteristic curves (continued)

Pressure/temperature curve
 CLS300 extended rod and cable probes
 ASME flanged process connections
 (7ML5650, 7ML5651, 7ML5660 and 7ML5661)

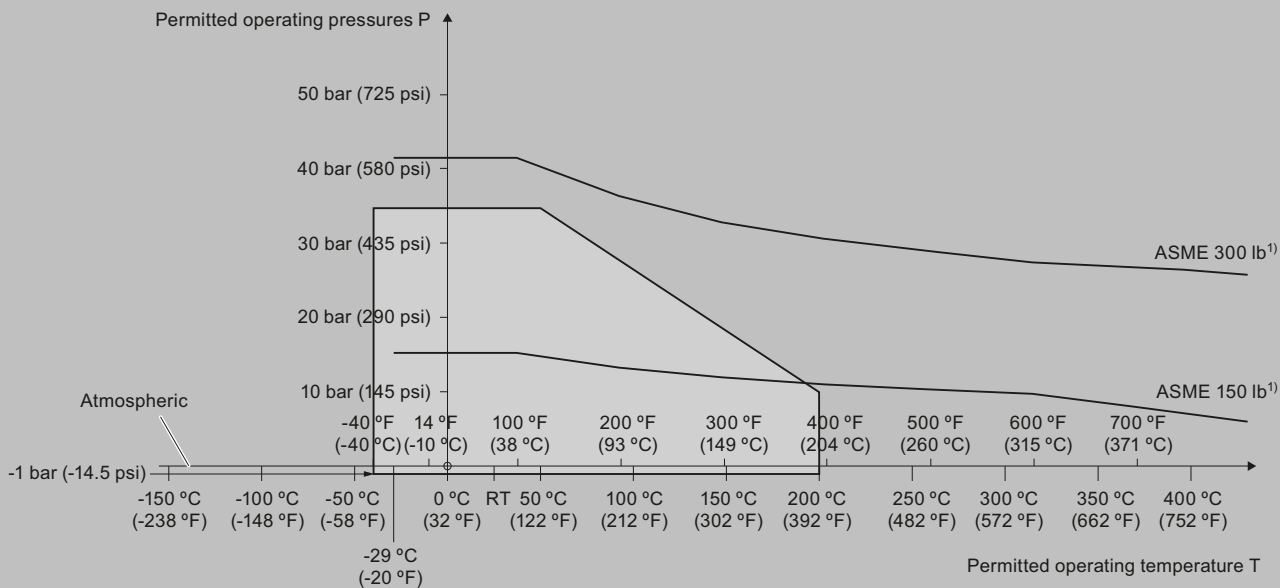

¹⁾ The curve denotes the minimum allowable flange class for the shaded area below.

Pointek CLS300 process pressure/temperature derating curves (7ML5650, 7ML5651, 7ML5660, and 7ML5661)

Characteristic curves (continued)

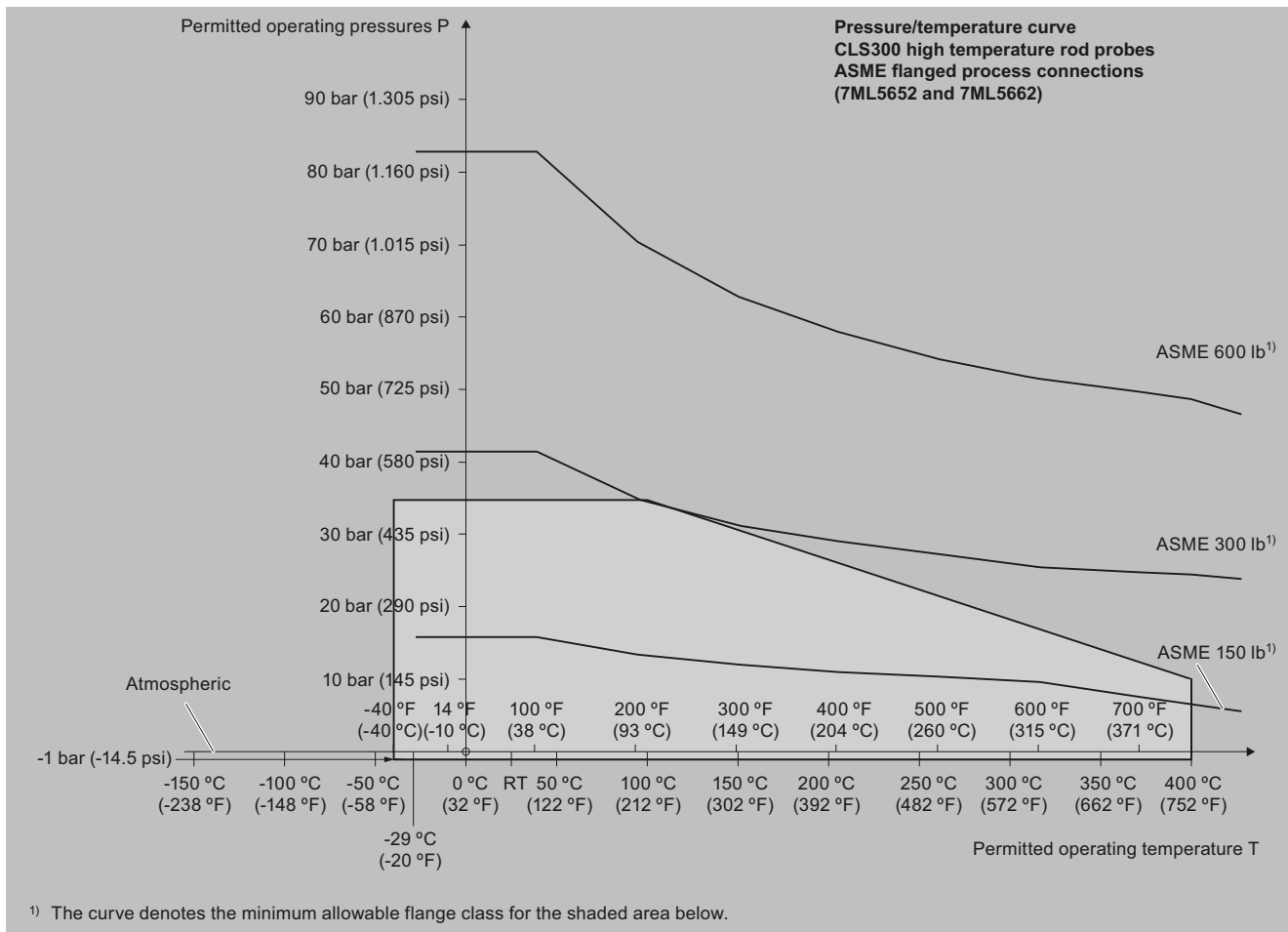

Pointek CLS300 process pressure/temperature derating curves (7ML5652 and 7ML5662)

Characteristic curves (continued)

Pressure/temperature curve
CLS300 extended rod and cable probes
EN flanged process connections
(7ML5650, 7ML5651, 7ML5660 and 7ML5661)

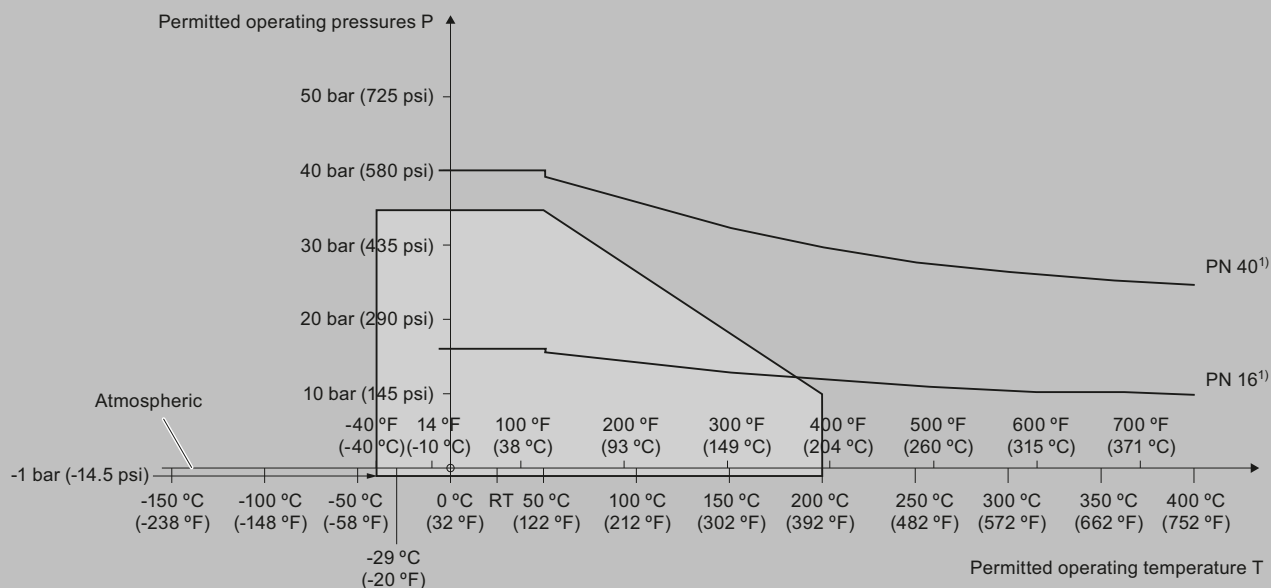

¹⁾ The curve denotes the minimum allowable flange class for the shaded area below.

Pointek CLS300 process pressure/temperature derating curves (7ML5650, 7ML5651, 7ML5660 and 7ML5661)

Pressure/Temperature Curve
CLS300 High Temperature Rod Probes
EN Flanged Process Connections (7ML5652 and 7ML5662)

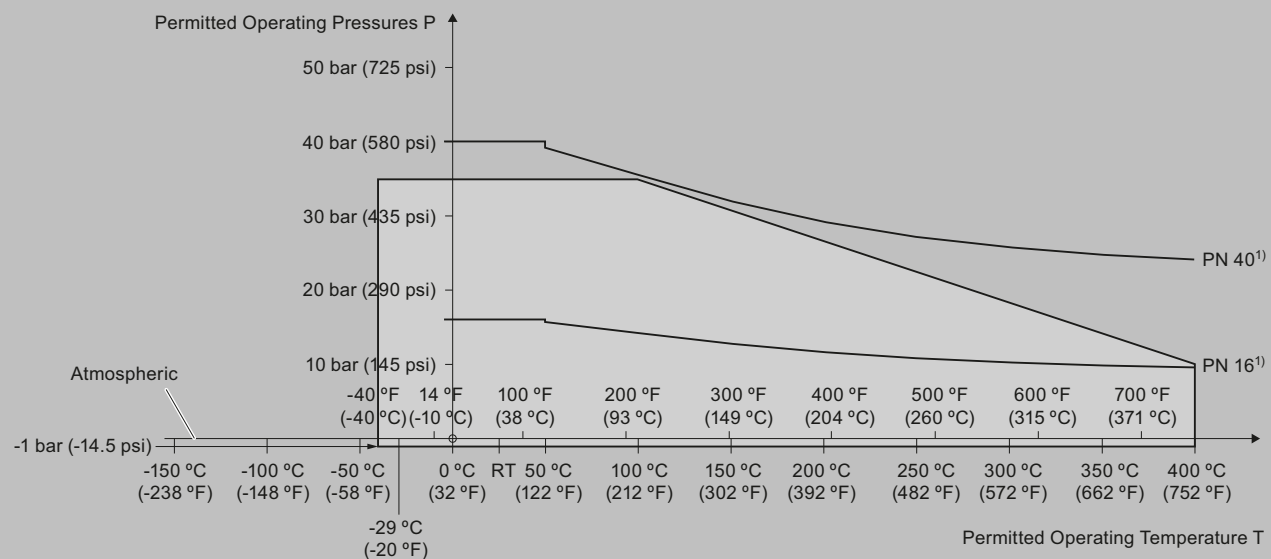

¹⁾ The curve denotes the minimum allowable flange class for the shaded area below.

Pointek CLS300 process pressure/temperature derating curves (7ML5652 and 7ML5662)

Pointek CLS300 - Digital

Dimensional drawings

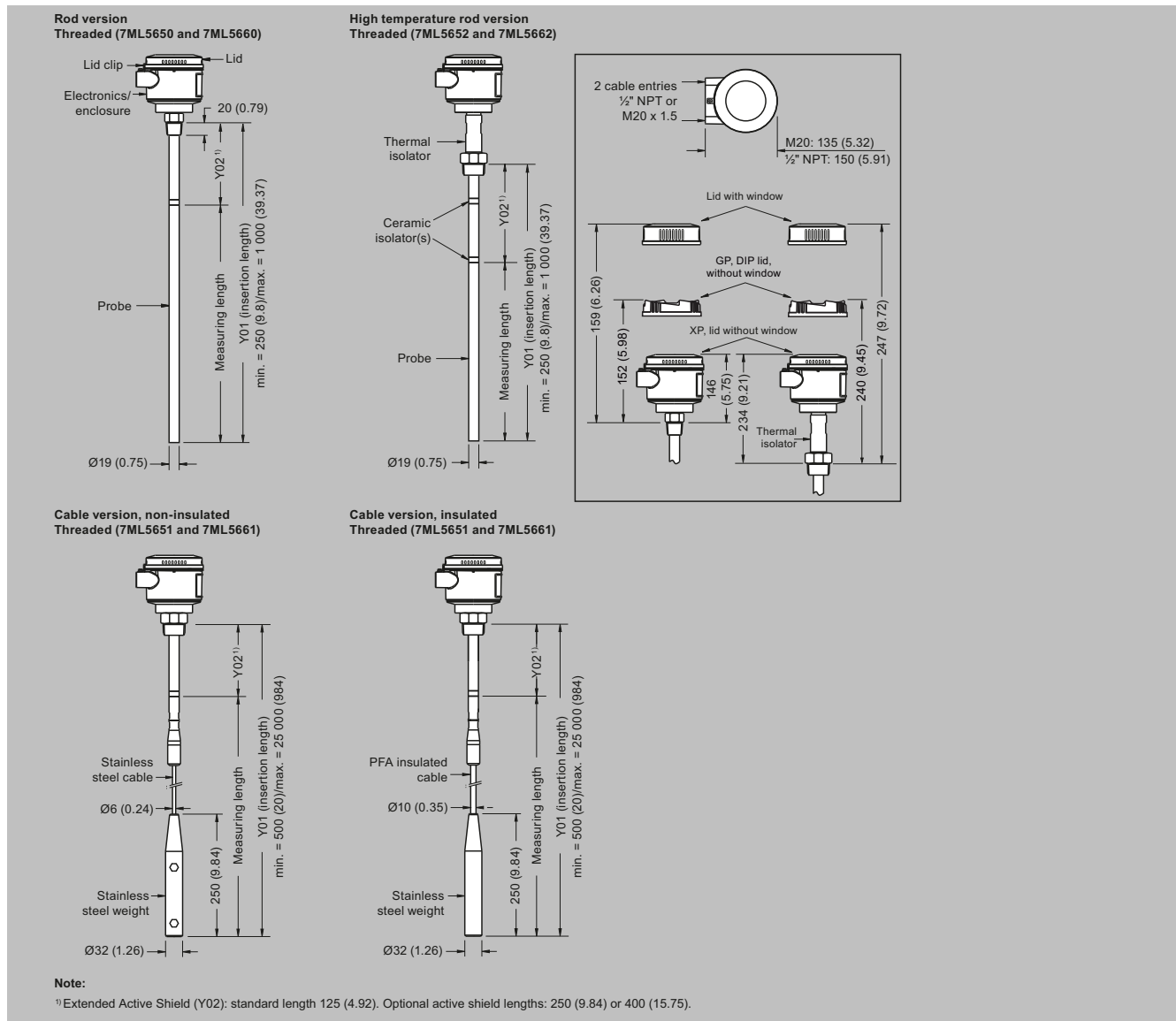

Pointek CLS300 threaded process connections, dimensions in mm (inch)

Dimensional drawings (continued)

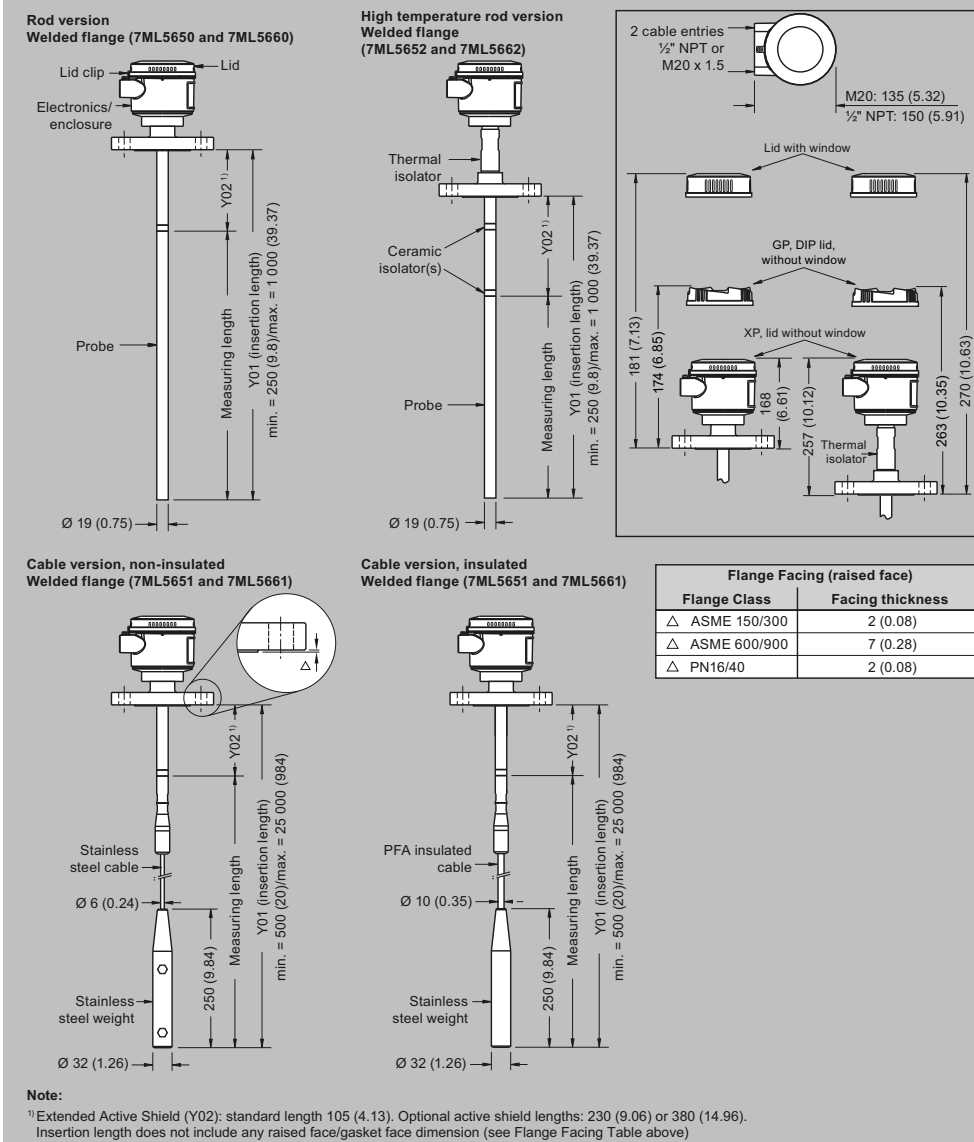

Pointek CLS300 flanged process connections, dimensions in mm (inch)

Pointek CLS300 - Digital

Circuit diagrams

Wiring: Pointek CLS300 standard

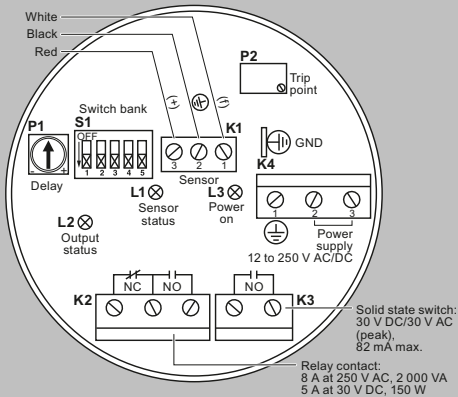

Notes:

- Identification label is on underside of lid. Switch and potentiometer settings are for illustration purposes only (refer to operation/setup in manual).
- All field wiring must have insulation suitable for at least 250 V.
- Relay contact terminals are for use with equipment having no accessible live parts and wiring having insulation suitable for at least 250 V.
- Maximum working voltage between adjacent relay contacts shall be 250 V.
- Refer to the Instruction manual or contact Siemens representative for detailed wiring information.

Wiring: Pointek CLS300 digital

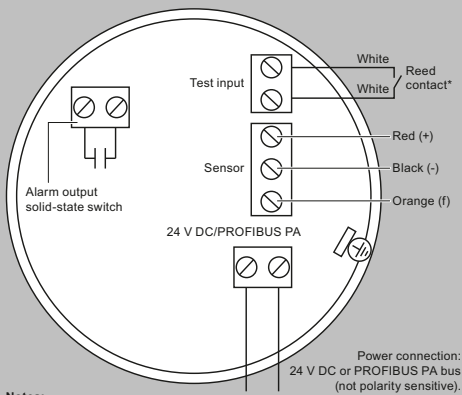

Notes:

- Refer to the instruction manual or contact a Siemens representative for detailed wiring information.

*Magnet activated sensor test

A magnet can be used to test the sensor without opening the lid of the Pointek CLS300 digital version. Bring the magnet close to the test area indicated on the enclosure. The sensor test starts and finishes automatically after 10 seconds.



Pointek CLS300 connections