

# SIEMENS

## SITRANS

### Communication and Displays SITRANS RD200

#### Operating Instructions

<u>SITRANS RD200</u>	<b>1</b>
<u>Technical specifications</u>	<b>2</b>
<u>Dimension drawings</u>	<b>3</b>
<u>Installing/mounting</u>	<b>4</b>
<u>Connection</u>	<b>5</b>
<u>Setup</u>	<b>6</b>
<u>Operating</u>	<b>7</b>
<u>Factory defaults</u>	<b>A</b>
<u>Troubleshooting tips</u>	<b>B</b>
<u>Quick user interface reference guide</u>	<b>C</b>
<u>Serial communication protocol</u>	<b>D</b>
<u>Modbus register tables</u>	<b>E</b>
<u>Product documentation and Support</u>	<b>F</b>

7ML5740 (RD200)



11/2022

A5E47629414-AB

## Legal information

### Warning notice system

This manual contains notices you have to observe in order to ensure your personal safety, as well as to prevent damage to property. The notices referring to your personal safety are highlighted in the manual by a safety alert symbol, notices referring only to property damage have no safety alert symbol. These notices shown below are graded according to the degree of danger.

 <b>DANGER</b>
indicates that death or severe personal injury <b>will</b> result if proper precautions are not taken.
 <b>WARNING</b>
indicates that death or severe personal injury <b>may</b> result if proper precautions are not taken.
 <b>CAUTION</b>
indicates that minor personal injury can result if proper precautions are not taken.
<b>NOTICE</b>
indicates that property damage can result if proper precautions are not taken.

If more than one degree of danger is present, the warning notice representing the highest degree of danger will be used. A notice warning of injury to persons with a safety alert symbol may also include a warning relating to property damage.

### Qualified Personnel

The product/system described in this documentation may be operated only by **personnel qualified** for the specific task in accordance with the relevant documentation, in particular its warning notices and safety instructions. Qualified personnel are those who, based on their training and experience, are capable of identifying risks and avoiding potential hazards when working with these products/systems.

### Proper use of Siemens products

Note the following:

 <b>WARNING</b>
Siemens products may only be used for the applications described in the catalog and in the relevant technical documentation. If products and components from other manufacturers are used, these must be recommended or approved by Siemens. Proper transport, storage, installation, assembly, commissioning, operation and maintenance are required to ensure that the products operate safely and without any problems. The permissible ambient conditions must be complied with. The information in the relevant documentation must be observed.

### Trademarks

All names identified by ® are registered trademarks of Siemens AG. The remaining trademarks in this publication may be trademarks whose use by third parties for their own purposes could violate the rights of the owner.

### Disclaimer of Liability

We have reviewed the contents of this publication to ensure consistency with the hardware and software described. Since variance cannot be precluded entirely, we cannot guarantee full consistency. However, the information in this publication is reviewed regularly and any necessary corrections are included in subsequent editions.

# Table of contents

<b>1</b>	<b>SITRANS RD200 .....</b>	<b>5</b>
1.1	Introduction .....	5
<b>2</b>	<b>Technical specifications .....</b>	<b>6</b>
2.1	Power .....	6
2.2	Mounting .....	6
2.3	Memory .....	7
2.4	Programming .....	7
2.5	Display .....	7
2.6	Outputs .....	8
2.7	Serial Communications .....	9
2.8	Inputs .....	9
2.9	Enclosure .....	10
2.10	Weight .....	10
2.11	Approvals .....	10
<b>3</b>	<b>Dimension drawings .....</b>	<b>11</b>
<b>4</b>	<b>Installing/mounting .....</b>	<b>13</b>
<b>5</b>	<b>Connection .....</b>	<b>15</b>
5.1	Connector Labeling .....	15
5.2	Power Connections .....	16
5.3	Signal Connections .....	16
5.4	Current and Voltage Connections .....	16
5.5	Thermocouple and RTD connections .....	18
5.6	Serial Communication .....	21
<b>6</b>	<b>Setup .....</b>	<b>23</b>
6.1	Main menu .....	26
6.2	Setting numeric values .....	27
6.3	Setting decimal point .....	28
6.4	Relay and Alarm Operation .....	33
6.4.1	Time delay operation .....	36
6.5	Scaling .....	40
6.6	Security .....	46
6.6.1	Unlocking the meter (unLC) .....	47

6.7	Advanced Features .....	47
6.7.1	Offset adjustment.....	49
6.7.2	Noise filter bypass (bYPS).....	50
6.7.3	Serial communications (SErL).....	51
6.7.4	SITRANS RD Software .....	53
6.7.5	Meter copy function .....	53
6.7.6	Meter cloning instructions .....	55
6.7.7	Troubleshooting .....	57
6.7.8	Determining software version .....	58
<b>7</b>	<b>Operating.....</b>	<b>59</b>
7.1	Front Panel Buttons Operation .....	59
7.2	Maximum/Minimum readings .....	59
<b>A</b>	<b>Factory defaults.....</b>	<b>60</b>
A.1	Factory defaults and user settings .....	60
<b>B</b>	<b>Troubleshooting tips .....</b>	<b>62</b>
<b>C</b>	<b>Quick user interface reference guide .....</b>	<b>63</b>
<b>D</b>	<b>Serial communication protocol .....</b>	<b>65</b>
D.1	Table of Commands.....	66
D.2	Command Packet Format.....	67
D.3	Reply Packet Format .....	68
D.4	Read only Commands .....	69
D.5	No-Data Commands.....	71
D.6	Read/Write Commands.....	72
<b>E</b>	<b>Modbus register tables.....</b>	<b>88</b>
E.1	Register Overview.....	88
E.2	Register Notes .....	96
E.3	Decimal Point .....	98
E.4	Relay Configuration .....	99
E.5	4-20 mA Output Mode.....	99
E.6	Available Register Table .....	99
<b>F</b>	<b>Product documentation and Support .....</b>	<b>100</b>
F.1	Product documentation .....	100
F.2	Technical support .....	101
	<b>Index.....</b>	<b>102</b>

# SITRANS RD200

## 1.1 Introduction

SITRANS RD200 is a universal input, panel mount remote digital display for process instrumentation.

It accepts a single input of current, voltage, thermocouple, or RTD signals, and the four front panel buttons make the setup and programming an easy task.

The isolated 24 V DC transmitter power (optional) can be used to power the input transmitter, the 4 to 20 mA output, or other devices.

Two relays (optional) can be used for alarm indication or process control applications, such as alternating pump control.

4-20 mA isolated output and Modbus® RTU serial communication options make SITRANS RD200 an excellent addition to any system.

### The Manual

This manual provides instructions for the SITRANS RD200 remote display. The manual is designed to help you get the most out of your Remote Display, and it provides information on the following:

- Product specifications
- Outline diagrams
- Installation requirements
- Wiring diagrams
- How to program the unit
- Principles of operation
- Troubleshooting tips
- Factory defaults
- Quick user reference

## Technical specifications

### 2.1 Power

<b>Input voltage option 1</b>	<ul style="list-style-type: none"> <li>85 to 265 V AC, 50/60 Hz; 90 to 265 V DC, 20 W max.</li> <li>UL Recognized, 5 A max, slow blow</li> <li>May share one 5 A fuse among up to 6 meters</li> </ul>		
<b>Input voltage option 2</b>	<ul style="list-style-type: none"> <li>12 to 36 V DC, 12 to 24 V AC, 6 W max.</li> <li>UL Recognized, 5 A max, slow blow</li> <li>May share one 5 A fuse among up to 6 meters</li> </ul>		
<b>Transmitter power supply</b>	One or two isolated transmitter power supplies (optional)	Single power supply:	one 24 V DC $\pm$ 10% @ 200 mA maximum
		Dual power supplies:	one 24 V DC $\pm$ 10% @ 200 mA maximum
			one 24 V DC $\pm$ 10% @ 40 mA maximum
<b>External loop power supply</b>	35 V DC maximum		
<b>Input impedance</b>	<ul style="list-style-type: none"> <li>Voltage ranges: greater than 1 M<math>\Omega</math></li> <li>Current ranges: 50 - 100 <math>\Omega</math> (depending on resettable fuse impedance)</li> </ul>		
<b>Output loop resistance</b>	<ul style="list-style-type: none"> <li>24 V DC 10 to 700 <math>\Omega</math> maximum</li> <li>35 V DC (external) 100 to 1200 <math>\Omega</math> maximum</li> </ul>		

### 2.2 Mounting

<b>Location</b>	<ul style="list-style-type: none"> <li>Indoor/outdoor</li> <li>Panel mount 1/8 DIN</li> <li>Two panel mounting bracket assemblies provided</li> </ul>
<b>Ambient temperature</b>	<ul style="list-style-type: none"> <li>Operating temperature range: -40 to +65 °C (-40 to +149 °F)</li> <li>Storage temperature range: -40 to +85 °C (-40 to +185 °F)</li> </ul>
<b>Relative humidity</b>	Relative humidity: 0 to 90% non-condensing
<b>Installation category</b>	II

## 2.3 Memory

- Non-volatile
- Stores settings for minimum of ten years if power is lost

## 2.4 Programming

<b>Primary</b>	Front panel
<b>Secondary</b>	<ul style="list-style-type: none"> <li>• Meter Copy</li> <li>• PC with SITRANS RD Software</li> </ul>

## 2.5 Display

<b>Display</b>	<ul style="list-style-type: none"> <li>• 14 mm (0.56") high, red LED</li> <li>• Four digits (-1999 to 9999), automatic lead zero blanking</li> <li>• Eight intensity levels</li> <li>• 2x option: 30.5 mm (1.20") high, red LED</li> </ul>
<b>Update Rate</b>	<ul style="list-style-type: none"> <li>• Process/RTD: 3.7 to 5/second</li> <li>• Thermocouple: 1.8 to 2.5/second</li> </ul>
<b>Overrange</b>	Display flashes 9999
<b>Underrange</b>	Display flashes -1999

## 2.6 Outputs

<b>mA Analog</b>	<ul style="list-style-type: none"> <li>• 4 to 20 mA</li> <li>• Isolated (optional)</li> </ul>
<b>Relays<sup>1)</sup></b>	<ul style="list-style-type: none"> <li>• 2 SPDT Form C relays, 3A (optional)</li> <li>• Auto initializing</li> <li>• All relays rated 3A @ 30 V DC or 3A @ 250 V AC, non-inductive</li> </ul>
<b>Control Relays</b>	<ul style="list-style-type: none"> <li>• Pump alternation</li> <li>• On and off time delay</li> <li>• Fail-safe or non fail-safe</li> <li>• Front panel ACK or PC</li> </ul>
<b>Alarm Relay</b>	<ul style="list-style-type: none"> <li>• High or low alarm</li> <li>• 0 to 100% deadband, user selectable</li> <li>• Auto and manual reset via front panel or PC</li> <li>• Latch or non-latch</li> </ul>
<b>Accuracy</b>	<ul style="list-style-type: none"> <li>• <math>\pm 0.1\%</math> FS <math>\pm 0.004</math> mA</li> </ul>

<sup>1)</sup>All relays are certified only for use with equipment that fails in a state or under the rated maximums of the relays.



## 2.7 Serial Communications

### Note

The RD200 does not support 8N1. It will be fixed to 8N2 when parity setting "None" is selected.

<b>Connections</b>	<ul style="list-style-type: none"> <li>PDC standard</li> <li>RS-232 or RS-422/485 running Modbus® RTU and ASCII via RJ-11 connector</li> </ul>	
<b>Setup</b>	Meter address	<ul style="list-style-type: none"> <li>PDC protocol: 0 to 99</li> <li>Modbus protocol: 1 to 247</li> </ul>
	Baud rate	<ul style="list-style-type: none"> <li>300 to 19200 bps</li> </ul>
	Transmit time delay	Programmable between 0 and 199 ms or transmitter always on for RS-422 communication
	Data	8 bit (1 start bit, 1 stop bit)
	Parity	None, even, odd (Modbus only; PDC protocol does not use parity)
	Byte-to-Byte timeout	0.01 to 2.54 sec (Modbus only)
	Turn around delay	Less than 2 ms (fixed)
<b>Software</b>	SITRANS RD Software	

Refer to Serial communication protocol (Page 65) and Modbus register tables (Page 88) for details.

## 2.8 Inputs

<b>Process (field selectable)</b>		<ul style="list-style-type: none"> <li>±20 mA DC (4 to 20 mA, 0 to 20 mA)</li> <li>±10 V DC (1 to 5 V, 0 to 5 V, 0 to 10 V)</li> </ul>
<b>Temperature (field selectable)</b>		<ul style="list-style-type: none"> <li>Thermocouple temperature: Type J, K, E, T, Type T using 0.1 ° display resolution</li> <li>RTD temperature: 100 Ω RTD</li> </ul>
<b>Accuracy</b>	Process	±0.05% of span ±1 count, square root: 10 to 100% FS
	Thermocouple temperature	<ul style="list-style-type: none"> <li>Type J: ±1 °C in range -50 to +750 °C (±2 °F in range -58 to +1382 °F)</li> <li>Type K: ±1 °C in range -50 to +1260 °C (±2 °F in range -58 to +2300 °F)</li> <li>Type E: ±1 °C in range -50 to +870 °C (±2 °F in range -58 to +1578 °F)</li> <li>Type T: ±1 °C in range -180 to +371 °C (±2 °F in range -292 to +700 °F)</li> <li>Type T, 0.1 °Res: ±1 °C in range -180.0 to +371 °C (±1.8 °F in range -199.9 to +700 °F)</li> </ul>
	RTD temperature	100 Ω RTD: ±1 °C in range -200 to +750 °C (±1 °F in range -328 to +1382 °F)

## 2.9 Enclosure

### 2.9 Enclosure

- High impact plastic, UL 94V-0
- Color: gray
- Degree of protection: front panel Type 4X, NEMA 4X, IP65; panel gasket provided
- 62 mm x 119 mm x 106 mm (2.45" x 4.68" x 4.19") (H x W x D)
- Optional thermoplastic, stainless steel, steel, for 1-6 meters (all with UL Listing and CSA Certification)
- Optional polycarbonate for 1 meter [available with optional zinc plated or stainless steel 2" (5.08 cm) mounting kits]

### 2.10 Weight

- 269 g (9.5 oz) (including options)

### 2.11 Approvals

- CE
- UKCA
- UL
- cUL

---

#### Note

Testing was conducted on SITRANS RD200 meters installed through the covers of grounded metal enclosures with cable shields grounded at the point of entry representing installations designed to optimize EMC performance.

---

## Dimension drawings

### RD200 Meter Dimensions - Side View

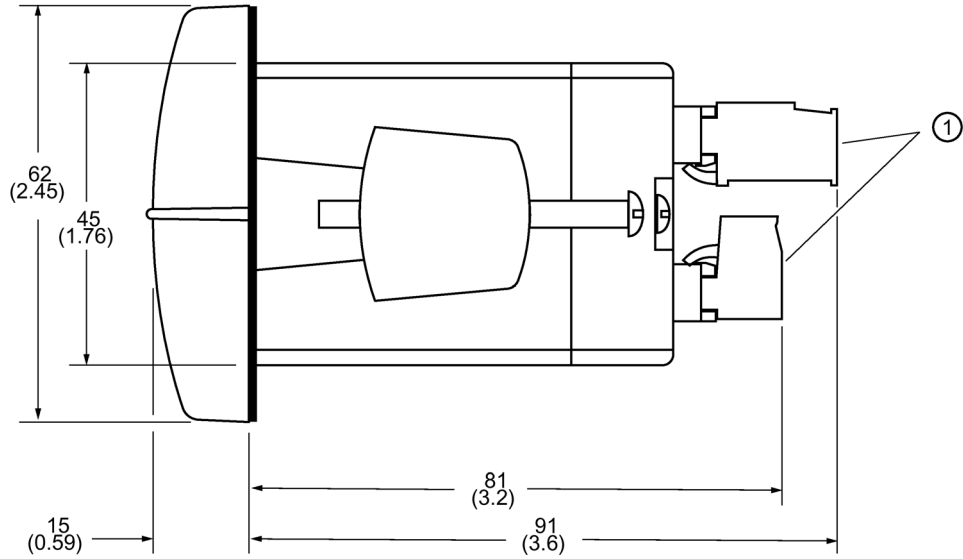

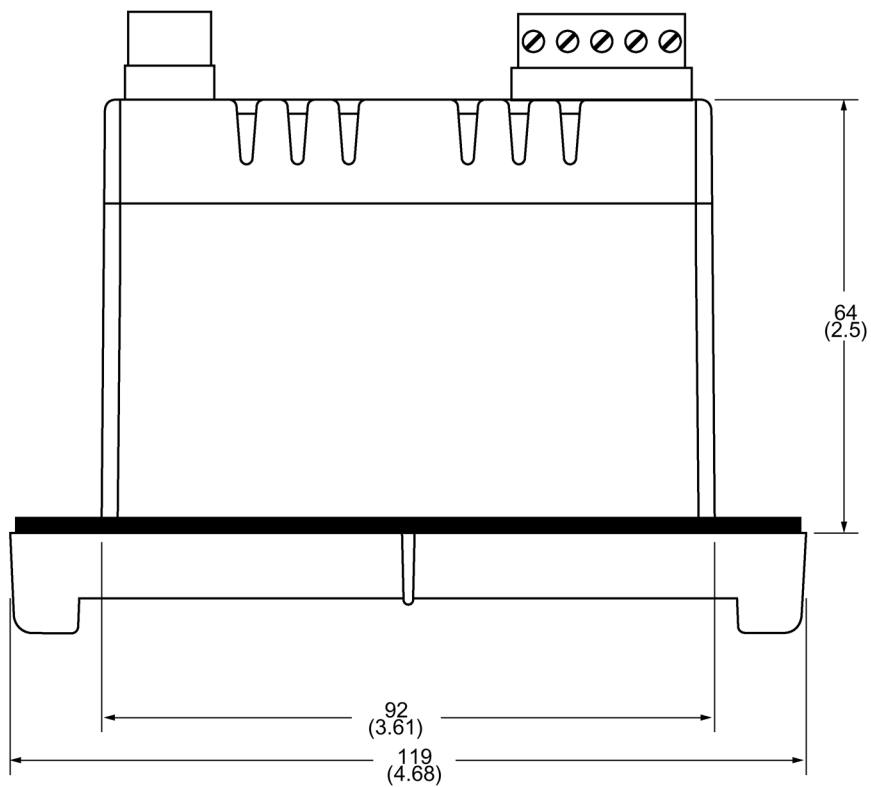

① Screw terminal connector [0.5 Nm (4.5 lb/in) tightening torque]

### RD200 Case Dimensions - Top View



# Installing/mounting

 <b>WARNING</b>
<b>Electrical shock</b> Risk of electrical shock.

 <b>WARNING</b>
<b>Hazardous voltages</b> Hazardous voltages exist within enclosure. Installation and service should be performed only by trained service personnel.

---

**Note**

- Read complete instructions prior to installation and operation of the meter.
  - There is no need to remove the meter from its case to complete the installation, wiring, and setup of the meter.
  - Installation must only be performed by qualified personnel, and in accordance with local governing regulations.
- 

**Unpacking**

Remove the meter from box. Inspect the packaging and contents for damage. Report damages, if any, to the carrier.

If any part is missing or the meter malfunctions, please contact your local Siemens representative for assistance.

### Panel Mounting Instructions

1. Prepare a standard 1/8 DIN panel cutout – 92 mm x 45 mm (3.622 " x 1.772 ").
  - Clearance: allow at least 102 mm (4") behind the panel for wiring
  - Panel thickness: 1.0 mm to 6.4 mm (0.04" to 0.25")
  - Recommended minimum panel thickness to maintain Type 4X rating: 1.5 mm (0.06 " ) steel panel, 4.1 mm (0.16 " ) plastic panel.

Refer to Troubleshooting tips (Page 62) for more details.

2. Remove the two mounting brackets provided with the meter. Back off the two screws so that there is 6.4 mm (1/4 ") or less through the bracket. Slide the bracket toward the front of the case and remove.
3. Insert meter into the panel cutout.
4. Install mounting brackets and tighten the screws against the panel. To achieve a proper seal, tighten the mounting bracket screws evenly until meter is snug to the panel along its short side. **DO NOT OVER TIGHTEN**, as the rear of the panel may be damaged.

### Panel Cutout and Mounting

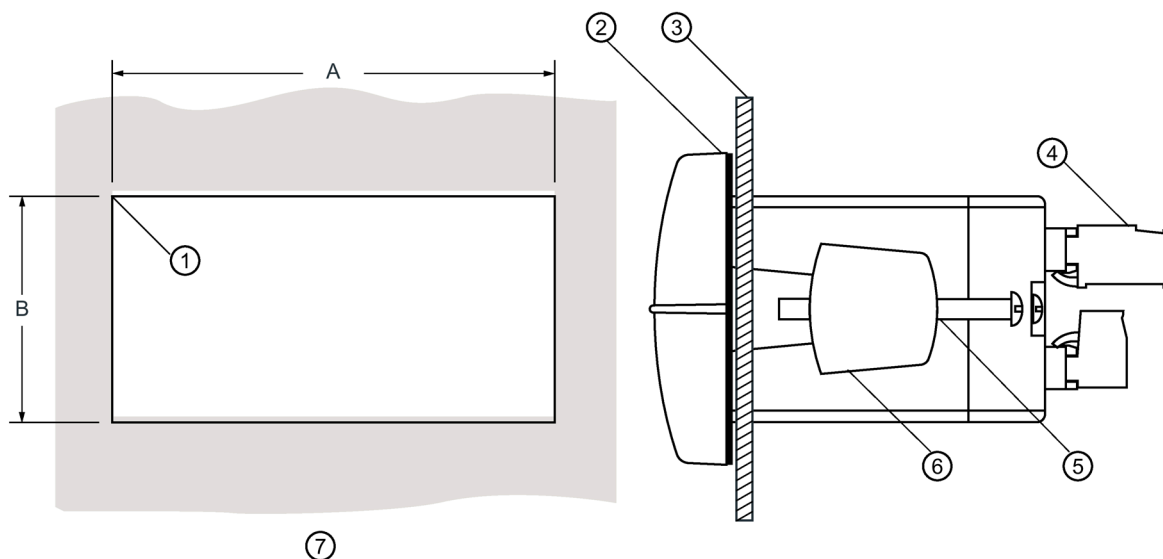

- ① Square corners to 1.5 mm (0.060") max. radius
- ② Gasket
- ③ Panel
- ④ Removable connectors
- ⑤ Mounting screw
- ⑥ Mounting bracket
- ⑦ Panel cutout to DIN 43700

A= 92 mm (3.622") + 0.8 mm (+0.032")

- 0.0 mm (+0.000")

B= 45 mm (1.772") + 0.6 mm (+0.024")

- 0.0 mm (+0.000")

## Connection

**! WARNING**

**Wiring requirements**

- Use copper wire with +60 °C or +60/75 °C (+140 °F or +140/167 °F) insulation for all line voltage connections.
- Observe all safety regulations.
- Electrical wiring should be performed in accordance with all applicable national, state, and local codes to prevent damage to the meter and ensure personnel safety.

**Note**

- Verify that all system components are installed in accordance with instructions.
- All connections are made to removable screw terminal connectors located at the rear of the meter.

### 5.1 Connector Labeling

The connectors label, affixed to the meter, shows the location of all connectors available with requested configuration. It also identifies the location of the RTD/TC selector switch.

#### Connector Labeling for Two Relays and 24 V Supply

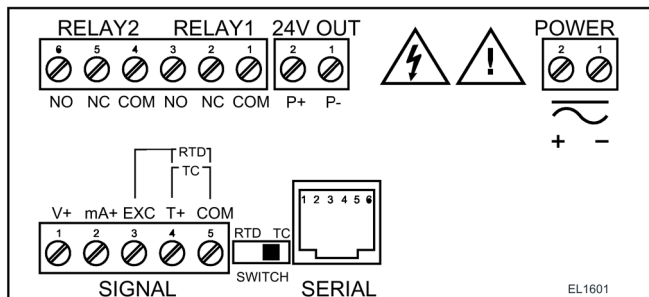

## 5.2 Power Connections

Power connections are made to a two-terminal connector labeled POWER on diagram Connector Labeling for Two Relays and 24 V Supply. The meter will operate regardless of DC polarity connection. The + and - symbols are only a suggested wiring convention.

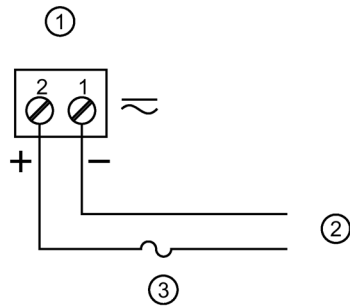

- ① Power connector
- ② AC or DC power
- ③ Required external fuse 5 A max. slow blow

## 5.3 Signal Connections

Signal connections are made to a five-terminal connector labeled SIGNAL on diagram Connector Labeling for Two Relays and 24 V Supply. The COM (common) terminal is the return for all types of input signals.

## 5.4 Current and Voltage Connections

The following figures show examples for current and voltage connections.

There are no switches or jumpers to set up for current and voltage inputs. Setup and programming is performed through the front panel buttons.



**Transmitter powered by ext. supply or self-powered**

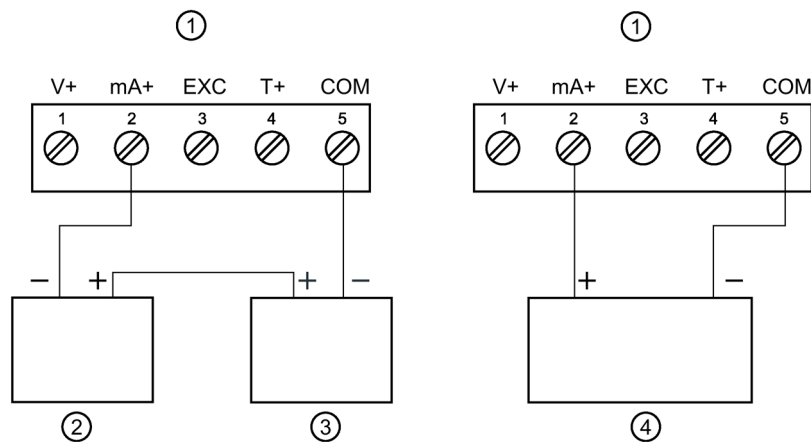

- ① Signal Connector
- ② 2-wire 4 to 20 mA transmitter
- ③ External power supply
- ④ 2-wire 4 to 20 mA self-powered transmitter

**Transmitter powered by internal supply (optional)**

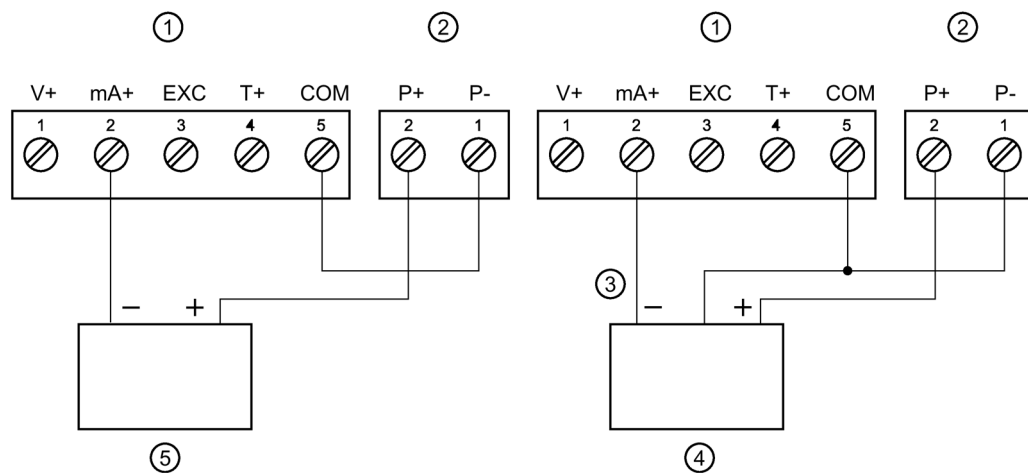

- ① Signal connector
- ② 24 V out
- ③ Signal
- ④ 3-wire 4 to 20 mA transmitter
- ⑤ 2-wire 4 to 20 mA transmitter

The current input is protected against current overload by a fuse capable of being reset. The display may or may not show a fault condition depending on the nature of the overload.

The fuse limits the current to a safe level when it detects a fault condition, and automatically resets itself when the fault condition is removed.

**Voltage input connections**

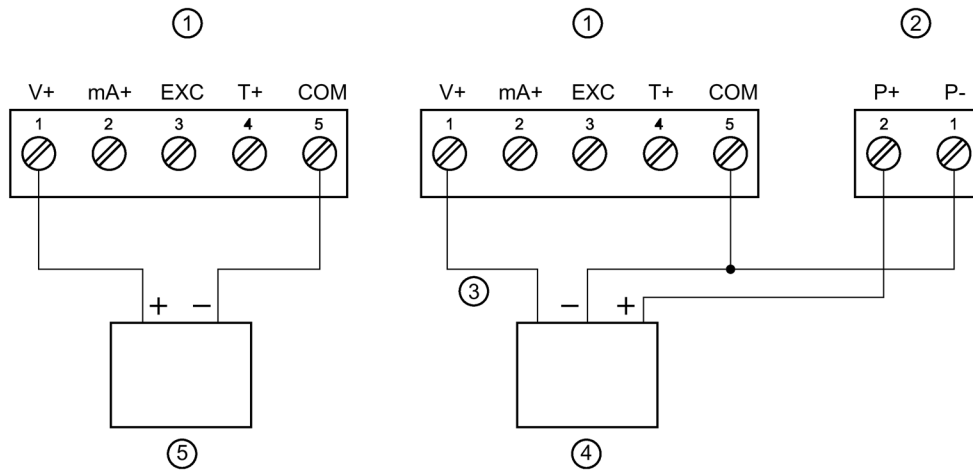

- ① Signal connector
- ② 24 V out
- ③ Signal
- ④ 3 wire voltage transducer
- ⑤ Voltage signal

The meter is capable of accepting any voltage from -10 V DC to +10 V DC.

## 5.5 Thermocouple and RTD connections

The following figures show examples for thermocouple and RTD connections.

The RTD/TC selector switch must be set to the proper position for the meter to accept the selected temperature input.

The input type is selected using the Setup (*SEtu*) menu.

Selected thermocouple input must correspond to thermocouple sensor and wire type used.

**Thermocouple input connections**

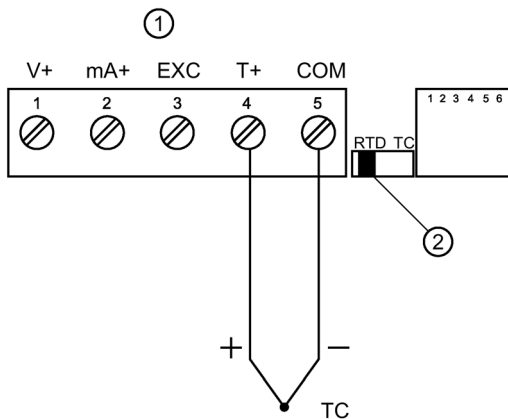

- ① Signal Connector
- ② Switch position

**Three-wire RTD input connections**

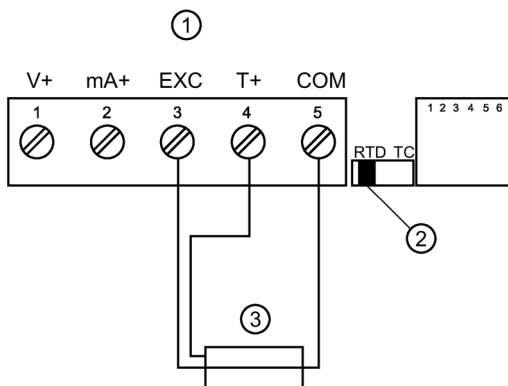

- ① Signal connector
- ② Switch position
- ③ RTD sensor

The meter accepts two, three, or four-wire RTDs. The three-wire RTD connection has built-in lead wire compensation.

**Two-wire RTD input connections**

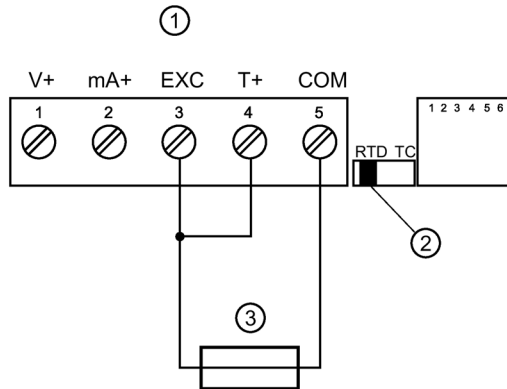

- ① Signal connector
- ② Switch position
- ③ RTD sensor

Lead wire compensation for two-wire RTDs can be applied using the Adjust (*Adj*) menu. See Offset adjustment (Page 49).

**Four-wire RTD input connections**

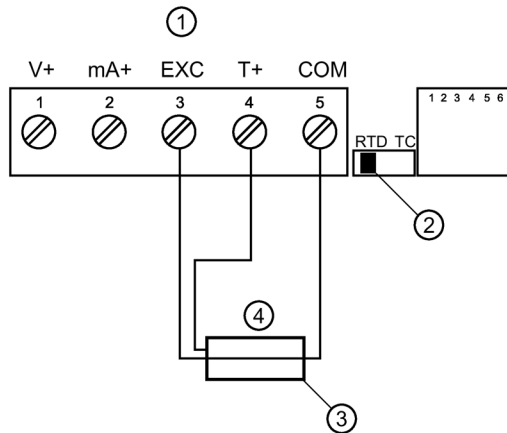

- ① Signal connector
- ② Switch position
- ③ NC
- ④ RTD sensor

The four-wire RTD connection is similar to the three-wire. One of the leads of a four-wire RTD is not connected, and may be clipped off.

The three-wire connection provides sufficient lead wire compensation to provide accurate readings even with long leads.

## 5.6 Serial Communication

Serial communication connection is made to an RJ11 connector labeled SERIAL on Connector Labeling (Page 15).

Device to use	For interfacing
RS232 serial adapter	RS232
RS422/485 serial adapter	RS422/485
SITRANS RD200 meter copy cable	Meter-to-meter (for cloning purposes - copying programmed settings from one meter to other meters)

### Relays and 24 V Output Connections

Relay connections are made to a six-terminal connector labeled RELAY1, RELAY2 on Connector Labeling (Page 15). The COM (common) terminals of the relays should not be confused with the COM (common) terminal of the SIGNAL connector. The 24 V DC output is available at the connector labeled 24V OUT, next to the relay connector.



Connections for the 4 to 20 mA transmitter output are made to the connector terminals labeled mA OUT, I-, I+. The 4 to 20 mA output may be powered from an internal power supply (optional) or from an external power supply.

#### 4 to 20 mA Output and Input Signal Powered by Meter

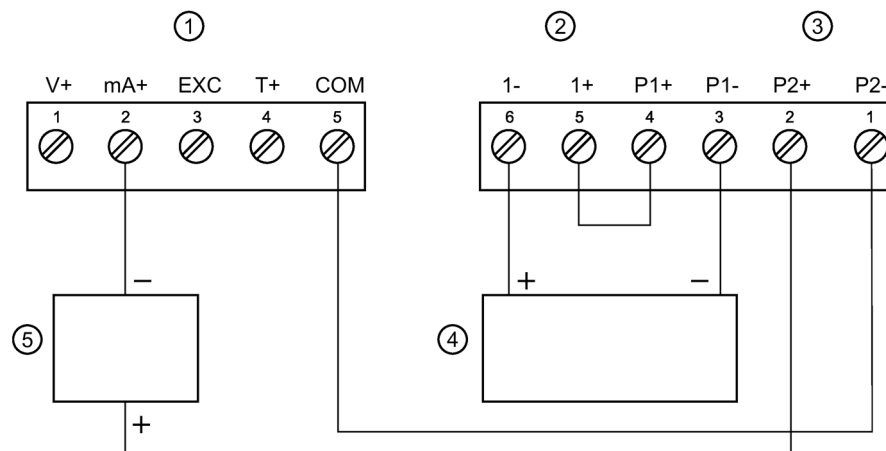

- ① Signal connector
- ② mA out
- ③ 24 V out
- ④ Remote display chart recorder
- ⑤ 2-wire 4 to mA transmitter

### 4 to 20 mA Output Powered Externally

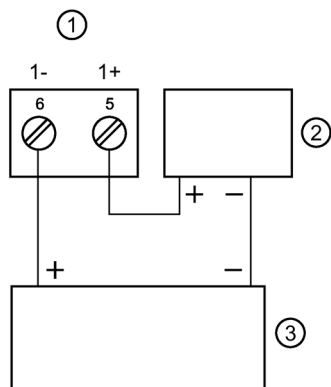

- ① mA out
- ② External power supply
- ③ Remote display chart recorder

## Setup

---

**Note**

- The meter is factory calibrated prior to shipment, for all input types, in milliamps, volts, and degrees respectively.
  - The calibration equipment is certified to NIST standards
- 

There are no jumpers involved in the setup of the meter. The RTD/TC selector switch, located between the SIGNAL and SERIAL connectors, must be set accordingly for the meter to accept RTD or thermocouple inputs. See Connector Labeling (Page 15).

Setup and program the device using the front panel buttons.

After power and signal connections have been completed and verified, apply power to the meter.

See Quick user interface reference guide (Page 63) for more details.

## Front panel buttons and status LED indicators



Button Symbol	Description	LED	Status
	Menu	1	Alarm 1
	Right arrow/ Reset	2	Alarm 2
	Up arrow/ Max	S	Set point indicator
	Enter/ Ack	R	Reset point indicator

Press **Menu** to enter or exit Program Mode at any time.

Press **Right arrow** to move to the next digit during programming.

Press **Up arrow** to scroll through the menus, decimal point, or to increment the value of a digit.

Press **Enter/Ack** to access a menu or to accept a setting.

Press and hold **Right arrow** and **Menu** for three seconds to access Advanced Features menu of the meter.



## Display functions and messages



The following table shows the displayed functions and messages with their action/setting description.



Display	Parameter	Action/Setting
SEtu	Setup	Enter Setup menu
inPt	Input	Enter Input menu
4-20	4-20 mA	Set meter for 4 to 20 mA input
0-10	0-10 VDC	Set meter for $\pm 10$ VDC input
rtd	RTD	Set meter for RTD input
A385	Alpha 385	Set $\alpha = 0.00385$ European curve 100 $\Omega$ RTD
A392	Alpha 392	Set $\alpha = 0.00392$ American curve 100 $\Omega$ RTD
tC	TC	Set meter for TC input
0 J	0 J	Type J
1 k	1 K	Type K
2 T	2 T	Type T
3 t.0	3 T.0	Type T, 0.1 $^\circ$ resolution
4 E	4 E	Type E
F C	$^\circ$ F or $^\circ$ C	Set temperature scale
$^\circ$ F	$^\circ$ F	Set meter to Fahrenheit
$^\circ$ C	$^\circ$ C	Set meter to Celsius
dEc.P	Decimal point	Set decimal point for process inputs
rELy	Relay	Enter the Relay menu
rLY1	Relay1	Relay 1 setup
Act1	Action1	Set relay 1 action (automatic, latching, etc.)
Auto	Automatic	Set relay for automatic reset
A-m	Auto-manual	Set relay for automatic + manual reset any time
LtCH	Latching	Set relay for latching operation
L-CL	Latching-cleared	Set relay for latching operation with manual reset only after alarm condition has cleared
Altr	Alternate	Set relays for pump alternation control
oFF	Off	Disable relay and front panel status LEDs Disable relay's fail-safe operation
SEt1	Set1	Program set point 1
rSt1	Reset1	Program reset point 1
rLY2	Relay2	Setup relay 2
Act2	Action2	Set relay 2 action (automatic, latching, etc.)
SEt2	Set2	Program set point 2
rSt2	Reset2	Program reset point 2
FLSF	Fail-safe	Enter Fail-safe menu
FLS1	Fail-safe1	Set relay 1 fail-safe operation
On	On	Enable fail-safe operation
FLS2	Fail-safe2	Set relay 2 fail-safe operation
dLay	Delay	Enter Time delay menu
dLy1	Delay1	Enter relay 1 time delay setup
On1	On1	Set relay 1 on time delay

OFF1	Off1	Set relay 1 off time delay
dLy2	Delay2	Enter relay 2 time delay setup
On2	On2	Set relay 2 on time delay
OFF2	Off2	Set relay 2 off time delay
Aout	Analog Output	Enter the Analog Output menu
SEbr	Sensor break	Program TC or RTD sensor break value for analog out
out1	Output 1	Program output 1 value (e.g. 4 mA)
out2	Output 2	Program output 2 value (e.g. 20 mA)
ProG	Program	Enter the Program menu
ScAL	Scale	Enter the Scale menu
CAL	Calibrate	Enter the Calibrate menu
inP1	Input 1	Calibrate input 1 signal or program input 1 value
diS1	Display 1	Program display 1 value
inP2	Input 2	Calibrate input 2 signal or program input 2 value
diS2	Display 2	Program display 2 value
err	Error	Error, calibration not successful, check signal
PASS	Password	Enter the Password menu
unLC	Unlocked	Program password to lock meter
LoCd	Locked	Enter password to unlock meter
9999 -1999 open	Flashing display	Overrange condition Underrange condition Open TC or RTD sensor

## 6.1 Main menu

The main menu includes the most common functions: Setup, Program, and Password.

Press **Menu**  to enter Program Mode then press **Up** arrow  to scroll through the main menu options; Setup (SEtu ), Program (ProG ), and Password (PASS ).



Press **Menu**  at any time to exit and return to Run Mode. Changes made to settings prior to pressing **Enter/Ack**  are not saved.

Changes to the settings are saved only after pressing **Enter/Ack** .



The display moves to the next menu every time a setting is accepted by pressing **Enter/Ack** .

## 6.2 Setting numeric values

The numeric values are set using the **Right** and **Up** arrow buttons.

When in programming mode and setting a numeric value, press **Right** arrow  to select next digit and **Up** arrow  to increment digital value.





The digit being changed is displayed brighter than the rest.

Press **Enter/Ack**  at any time to accept a setting or **Menu**  to exit without saving changes.

### Setting up the meter (SEtu)

The Setup menu is used to select:

- Input signal the meter will accept
- Decimal point position for process inputs
- Units (°F or °C) for temperature inputs
- Relay operation
- 4 to 20 mA analog output setup

From Run mode, press **Menu**  to access any menu or press **Up** arrow  to scroll through choices. Use **Enter/Ack**  to accept any entry and press **Menu**  to exit at any time.

---

#### Note

- The relay menu is always available even if the relay option is not installed.
  - Visual alarm indication is available through front panel LEDs and the SITRANS RD Software.
  - The Analog Output menu is available if selected in the Advanced Features menu. 4 to 20 mA output option board is installed and set up at the factory.
-







## 6.3 Setting decimal point

Decimal point for temperature inputs is fixed.

Decimal point for process inputs may be set with up to three decimal places or with no decimal point at all.



Pressing **Up** arrow  moves the decimal point one place to the right until no decimal point is displayed, then it moves to the leftmost position.

### To change the decimal point:

1. Press **Menu**  to enter Program Mode. *SEtu* is displayed.
2. Press **Enter/Ack**  to access the Setup menu. *inPt* is displayed.
3. Press **Up**  arrow to select decimal point modification. *dEc.P* is displayed.
4. Press **Enter/Ack**  to display decimal point setting.
5. Press **Up** arrow  to move the decimal point from left to right.
6. Press **Enter/Ack**  to accept the displayed setting.
7. Press **Menu**  to return to Run Mode.

## Setting the temperature scale (F C)

### Set meter to display temperature in degrees Fahrenheit or Celsius:





1. Press **Menu**  to enter Program Mode. *SEtu* is displayed.
2. Press **Enter/Ack**  to access Setup menu.
3. Press **Up**  arrow until temperature selection menu is displayed (*F C*).

---

### Note

The temperature selection menu will only be available if the meter has been set up for TC or RTD input. See Setting decimal point (Page 28).

---

4. Press **Enter/Ack**  to access the temperature selection menu.
5. Press **Up**  arrow to scroll through choices; *F* or *C*.
6. Press **Enter/Ack**  to set Fahrenheit or Celsius input.
7. Press **Menu**  to return to Run Mode.







## Setting the input signal (inPt)

Enter the Input menu to set up the meter to display current (4-20), voltage (0-10), thermocouple (*tC*), or RTD (*rtd*) inputs.







The voltage input is capable of accepting any signal from -10 to +10 V DC. Select voltage input to accept 0-5, 1-5, 0-10, or  $\pm 10$  V DC signals.

The current input is capable of accepting any signal from -20 to 20 mA. Select current input to accept 0 to 20 or 4 to 20 mA signals.











**Setup meter to display current (4-20) input:**

1. Press **Menu**  to enter Programming Mode. *SEtu* is displayed.
2. Press **Enter/Ack**  to access Setup menu. *inPt* is displayed.
3. Press **Enter/Ack**  to access Input menu.
4. Press **Up** arrow  to scroll through choices; 4-20, 0-10, tC, rtd.
5. When 4-20 is displayed, press **Enter/Ack**  to accept this choice.
6. Press **Menu**  to return to Run Mode.

**Setup meter to display voltage (0-10 ) input:**

1. Press **Menu**  to enter Program Mode
2. Press **Enter/Ack**  to access Setup menu.
3. Press **Enter/Ack**  to access Input menu.
4. Press **Up** arrow  to scroll through choices; 4-20, 0-10, tC, rtd.
5. When 0-10 is displayed, press **Enter/Ack**  to accept this choice.
6. Press **Menu**  to return to Run Mode.











**Setup meter to display thermocouple (tC ) input:**

1. Press **Menu**  to enter Program Mode. *SEtu* is displayed.
2. Press **Enter/Ack**  to access Setup Menu. *inPt* is displayed.
3. Press **Enter/Ack**  to access Input menu.
4. Press **Up**  arrow to scroll through choices; 4-20, 0-10, tC, rtd.
5. When tC is displayed, press **Enter/Ack**  .
6. Press **Up**  arrow until 1 H is displayed.
7. Press **Enter/Ack**  to accept choice. *F C* is displayed.
8. Press **Enter/Ack**  to set Fahrenheit or Celsius input.
9. Press **Up**  arrow to scroll through choices.
10. Press **Enter/Ack**  to accept a choice.
11. Press **Menu**  to return to Run Mode.

**Note**

- If tC is selected, the input signal must be connected to the appropriate input terminals and the RTD/TC selector switch must be set accordingly, see Thermocouple and RTD connections (Page 18).
- For thermocouple inputs, allow at least 30 minutes warm-up time for meter to reach specified accuracy.

**Setup meter to display RTD (*rtd*) input:**

1. Press **Menu**  to enter Programming Mode. *SEtu* is displayed.
2. Press **Enter/Ack**  to access Setup menu. *inPt* is displayed.
3. Press **Enter/Ack**  to access Input menu.
4. Press **Up** arrow  to scroll through choices; *4-20*, *0-10*, *tC*, *rtd*.
5. When *rtd* is displayed, press **Enter/Ack** .
6. The display shows **A385** or **A392**. Select the coefficient to match the RTD sensor, either 0.00385 (European curve) or 0.00392 (American curve). Press **Enter/Ack**  to accept your selection. *F C* is displayed.
7. Press **Enter/Ack**  to set Fahrenheit or Celsius input.
8. Press **Up** arrow  to scroll through choices.
9. Press **Enter/Ack**  to accept a choice.
10. Press **Menu**  to return to Run Mode.

---

**Note**







- If *rtd* is selected, the input signal must be connected to the appropriate input terminals and the RTD/TC selector switch must be set accordingly, Thermocouple and RTD connections (Page 18).
  - For thermocouple inputs, allow at least 30 minutes warm-up time for meter to reach specified accuracy.
-

## Setting relay operation (rELY)

This menu allows you to set up the operation of the relays:

- Relay action
  - Automatic reset only (non-latching)
  - Automatic + manual reset at any time (non-latching)
  - Latching (manual reset only)
  - Latching with Clear (manual reset only after alarm condition has cleared)
  - Pump alternation control (automatic reset only)
  - Off (relay and status LED disabled)
- Set point
- Reset point
- Fail-safe operation
  - On (enabled)
  - (disabled)
- Time delay
  - On delay (0-199 seconds)
  - Off delay (0-199 seconds)



### Set Up Relays (rLY1, rLY2), Set points (SEt1, SEt2), and Reset points (rSt1, rSt2):

1. Press **Menu**  to enter Program Mode.
2. *SEtu* is displayed. Press Enter/Ack to access the Setup menu.
3. Press **Up** arrow  until *rELY* is displayed.
4. Press **Enter/Ack**  to enter Relay menu.
5. *rLy1* is displayed. Press **Enter/Ack**  to set up relay 1.
6. *Act1* is displayed. The relay Action menu allows the user to set up the action of the relays.  
Press **Enter/Ack**  to set up action for relay 1.
7. Press **Up** arrow  to scroll through choices;
  - Auto* (Automatic reset only, non-latching),
  - A -m* (Automatic + manual reset at any time, non-latching),
  - LtCH* (Latching, manual reset only),
  - L -CL* (Latching with Clear, manual reset only after alarm condition has cleared),
  - ALtr* (Pump alternation control, automatic reset only),
  - oFF* (Off, relay and status LED disabled).
 When your choice is displayed, press **Enter/Ack**  to set relay 1 action (*Act1* ).

8. *SEt1* is displayed. The set point can be set to High Alarm Indication by programming the set point above the reset point.

The set point can be set to Low Alarm Indication by programming the set point below the reset point.

Press **Enter/Ack**  to enter set point 1 programming.

9. Press **Right arrow**  to change active digit and the **Up arrow**  to increment active digit.

10. Press **Enter/Ack**  to save displayed value.

11. *rSt1* is displayed. Press **Enter/Ack**  to enter reset point 1 programming and follow steps 8 and 9 above to program reset point 1 value.

---

#### Note

The deadband is determined by the difference between set and reset points. Minimum deadband is one display count. If set and reset points are programmed the same, relay will reset one count below set point.











---

12. *rLY2* is displayed. Press **Enter/Ack**  to set up relay 2 or press Menu to exit and return to Run Mode.

### Setting fail-safe operation (FLSF: FLS1, FLS2)

The fail-safe operation is set independently for each relay. Select *on* to enable or select *off* to disable fail-safe operation.

#### Set up relays for fail-safe operation:

1. Press **Menu**  to enter Program Mode.
2. Press **Enter/Ack**  to access the Setup menu.
3. Press **Up arrow**  until *rELy* is displayed.
4. Press **Enter/Ack**  to enter Relay menu.
5. Press **Up arrow**  until *FLSF* is displayed.
6. Press **Enter/Ack**  to access Fail-Safe Menu. *FLS1* is displayed.
7. Press **Enter/Ack**  to set up fail-safe feature for relay 1.
8. Press the **Up arrow**  to switch on or off.
9. Press **Enter/Ack**  to accept settings. *FLS2* is displayed.
10. Press **Enter/Ack**  to set up fail-safe feature for relay 2 as in steps 7-9, or press Menu to exit and return to Run Mode.

Once the Fail-Safe operation has been enabled, under normal conditions, the relays are on, and under alarm conditions, the relays are off. (Notice that the functionality of the relays is reversed when the Fail-Safe operation is disabled.)















### Programming time delay (dLA: dLy1, dLy2)

The *On* and *OFF* time delays may be programmed for each relay between 0 and 199 seconds. The relays will transfer only after the condition has been maintained for the corresponding time delay.

The *On* time delay is associated with the set point.

The *OFF* time delay is associated with the reset point.

#### Set up relay on and off time delays:

1. Press **Menu**  to enter Program Mode.
2. Press **Enter/Ack**  to access the Setup menu.
3. Press **Up**  arrow until rELy is displayed.
4. Press **Enter/Ack**  to enter Relay menu.
5. Press **Up**  arrow until dLAY is displayed.
6. Press **Enter/Ack**  to enter Time Delay Menu. dLy1 is displayed.
7. Press **Enter/Ack**  to set time delay for relay 1. On1 is displayed.
8. Press **Enter/Ack**  to proceed.
9. Press **Up**  arrow to change digit and Right arrow to change active digit.
10. Press **Enter/Ack**  to accept setting.
11. Repeat steps 6-7 for *OFF1*. dLy2 is displayed.
12. Press **Enter/Ack**  to set up time delay for relay 2 as in steps 8-10, or press **Menu**  to exit and return to Run Mode.

The *On* time delay will count down when the set point is reached and the relay will turn on after the time delay has elapsed. The *OFF* time delay will count down when the reset point is reached and the relay will turn off after the time delay has elapsed.

## 6.4 Relay and Alarm Operation

The following graphs illustrate the operation of the relays, status LEDs, and **Enter/Ack**  button.

High alarm operation (Set > Reset)

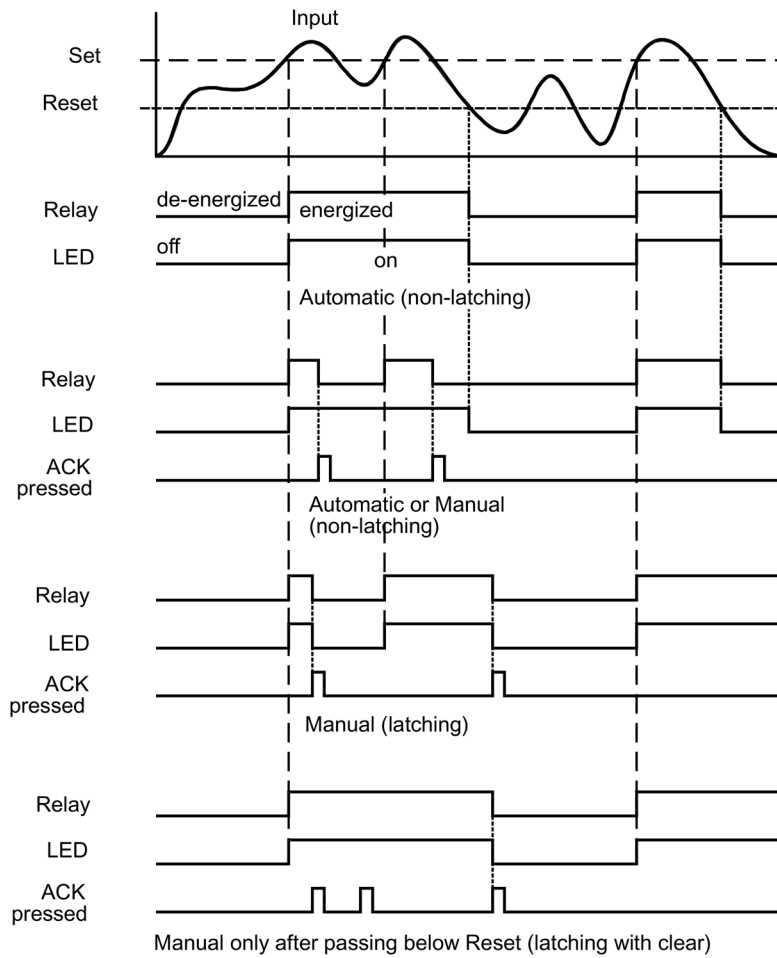

For Manual reset mode, **Enter/Ack**  can be pressed at any time to turn off relay. For relay to turn back on, signal must go below setpoint, and then go above it.

### Low alarm operation (Set < Reset)

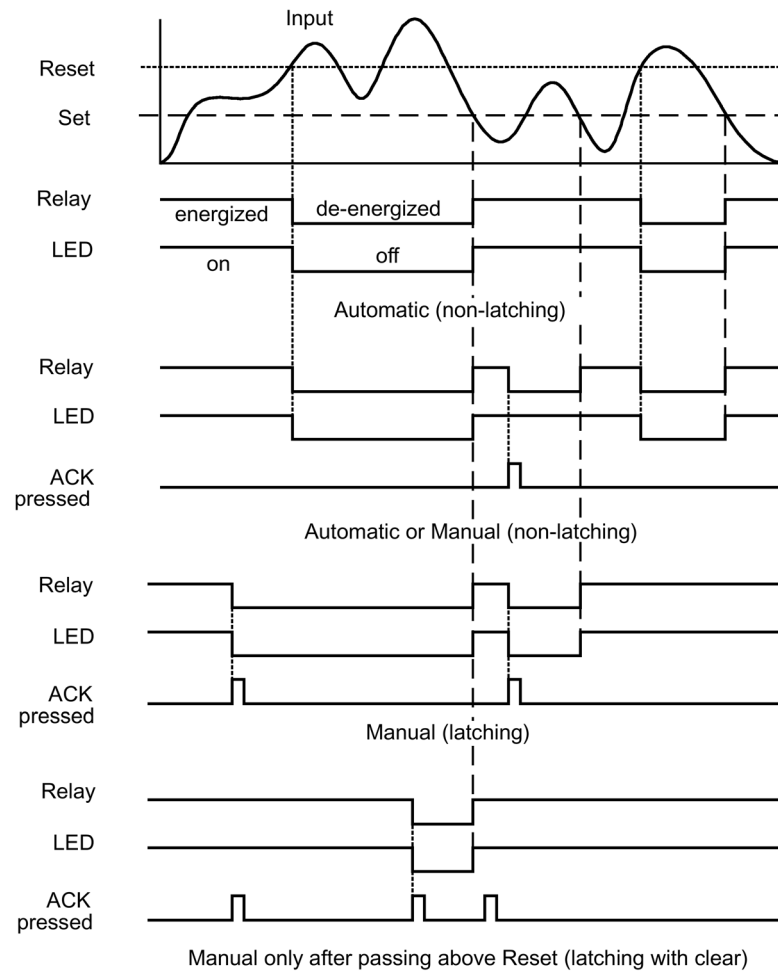

For Manual reset mode, **Enter/Ack**  can be pressed at any time to turn off relay. For relay to turn back on, signal must go below setpoint, and then go below it.

### 6.4.1 Time delay operation

The following graphs show the operation of the time delay function.

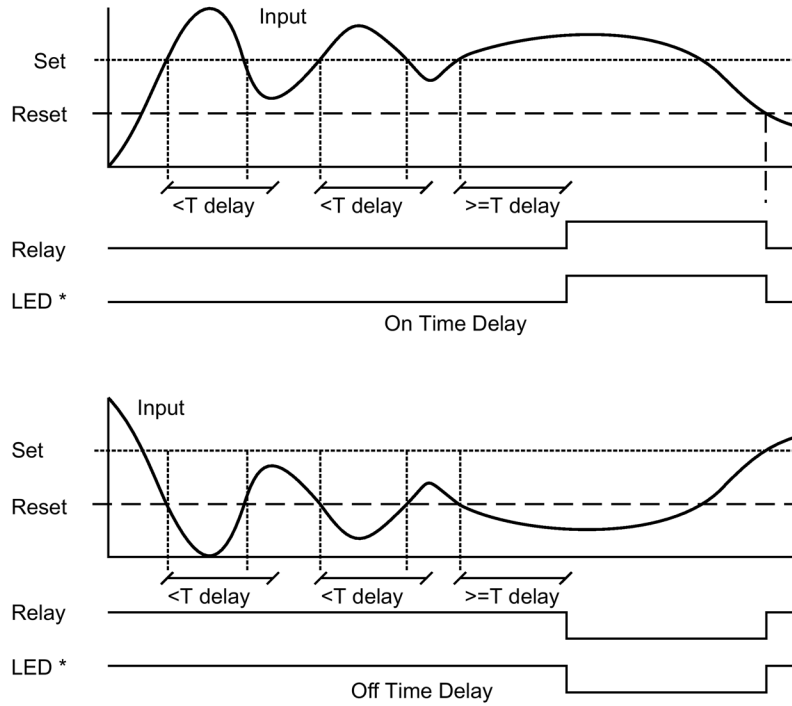

**Note**

The LED is not affected by Time Delay when **Automatic** or **Manual** reset mode is selected. Rather, the LED follows the set and reset points.

If the signal crosses the set point, the *On* time delay timer starts and the relay trips when the time delay has elapsed. If the signal drops below the set point (high alarm) before the time delay has elapsed, the *On* time delay timer resets and the relay does not change state. The same principle applies to the *OFF* time delay.

**High alarm with fail-safe operation (Set > Reset)**

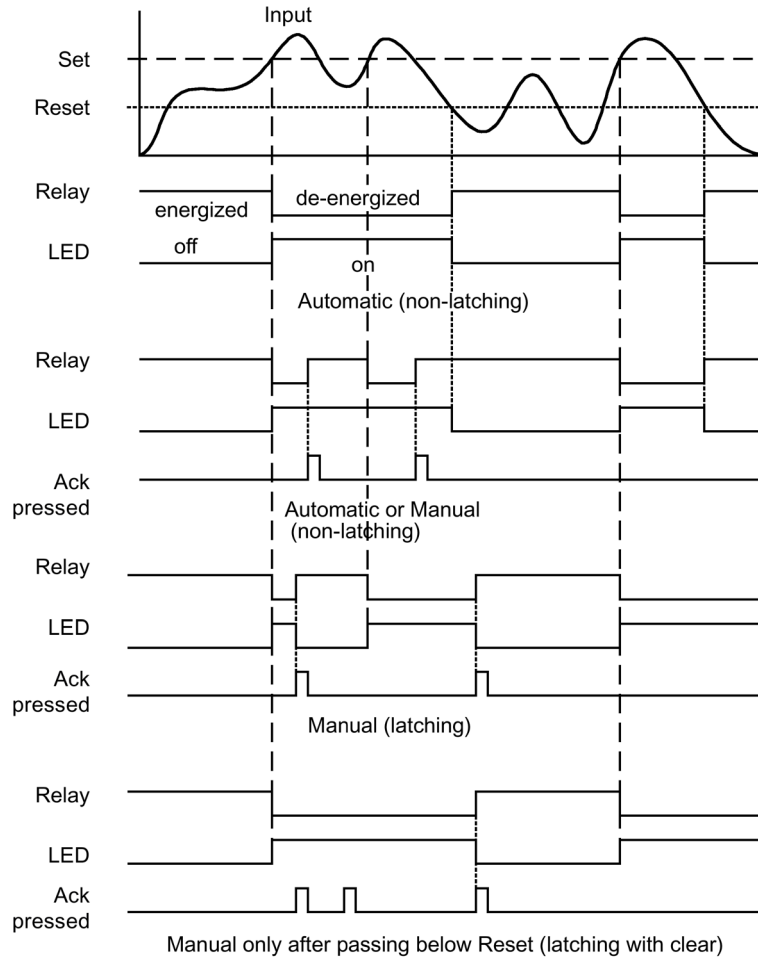

The relay coil is energized in non-alarm condition. In case of a power failure, the relay will go to alarm state.

**Low alarm with fail-safe operation (Set < Reset)**

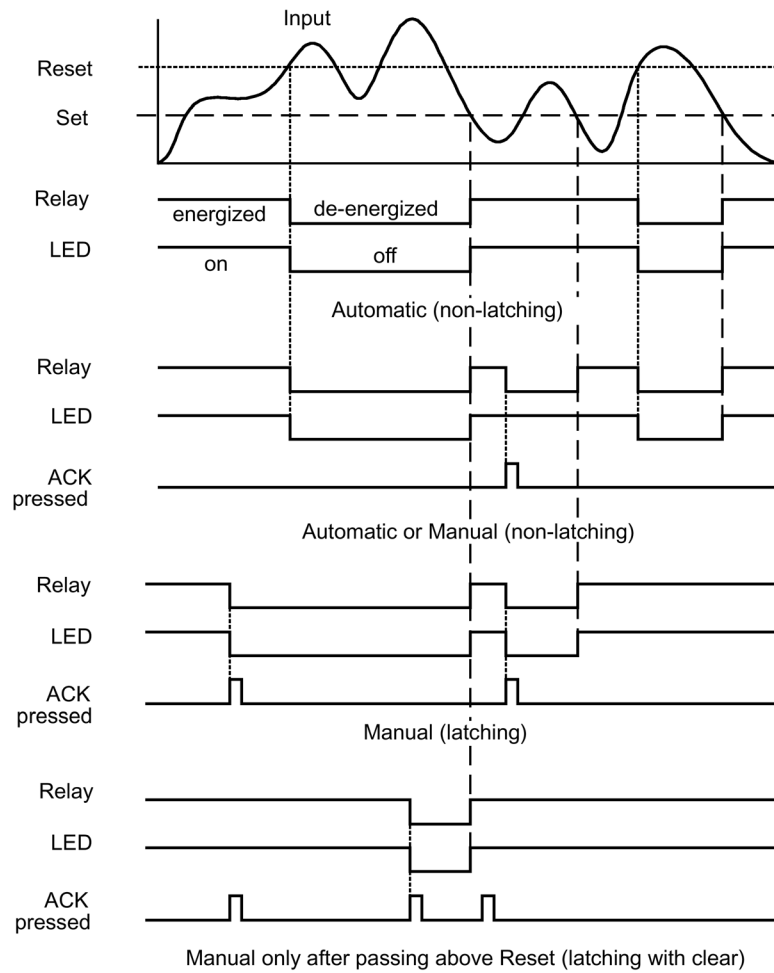

The relay coil is energized in non-alarm condition. In case of a power failure, the relay will go to alarm state.

Alternating pumps- mode: automatic (non-latching)

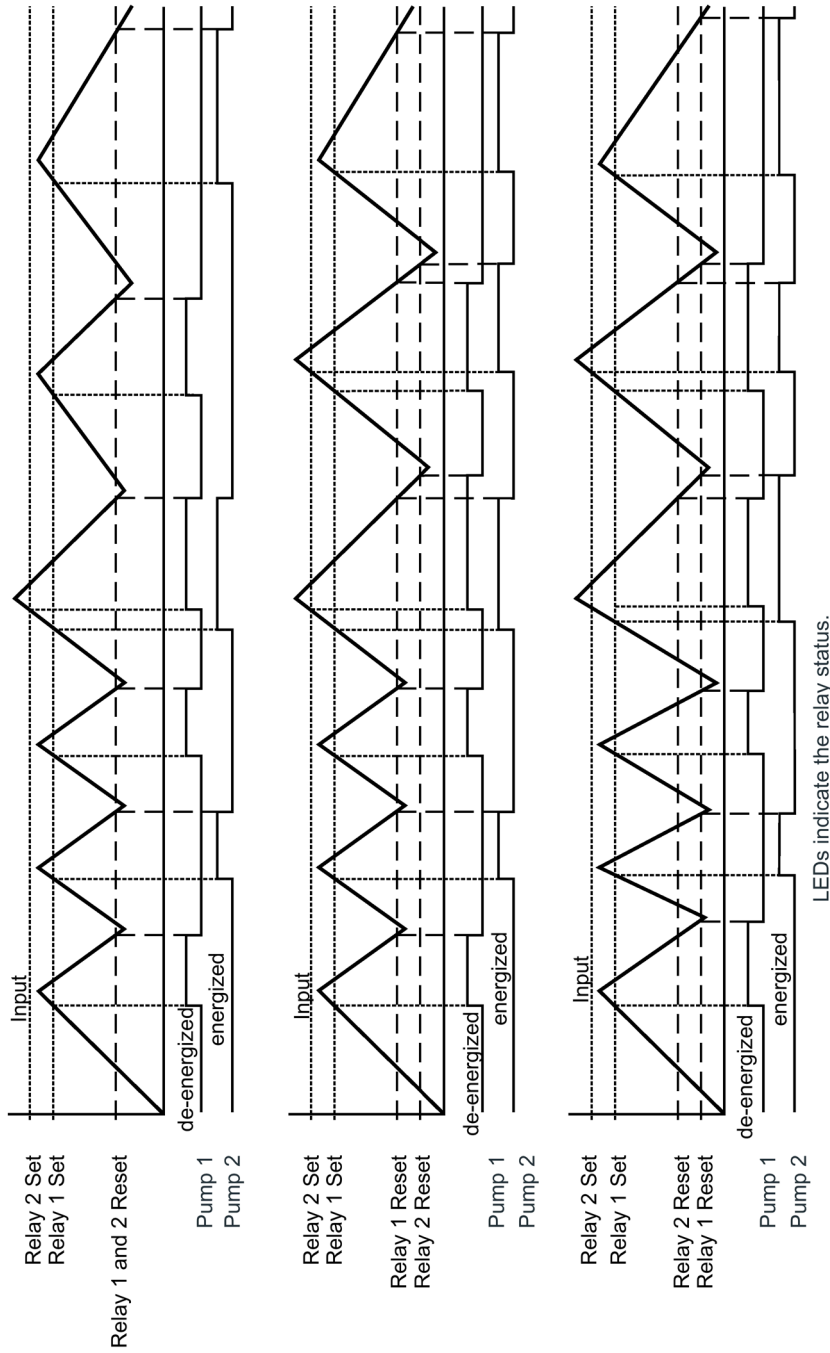

## 6.5 Scaling















### Scaling the 4 to 20 mA analog output (Aout)

The 4 to 20 mA analog output can be scaled to provide a 4 to 20 mA signal for any display range selected.

No equipment is needed to scale the analog output; simply program the display values to the corresponding mA output signal.

The Analog Output menu is used to program 4 to 20 mA output based on display values.

#### Scale output based on display values

1. Press **Menu**  to enter Program Mode. *SEtu* is displayed.
2. Press **Enter/Ack**  to accept. *inPt* is displayed.
3. Press **Up** arrow  until the *Aout* menu is displayed. Press **Enter/Ack**  to accept. *scal* is displayed.
4. Press **Enter/Ack**  to access the scale menu. *diS1* is displayed.
5. Press **Enter/Ack**  to set value for display 1.
6. Press **Up** arrow  to change digit and **Right** arrow  to change active digit.
7. Press **Enter/Ack**  to accept setting. *out1* is displayed.
8. Press **Enter/Ack**  to set value for output 1.
9. Press **Up** arrow  to change digit and **Right** arrow  to change active digit.
10. Press **Enter/Ack**  to accept setting. *diS2* is displayed.
11. Press **Enter/Ack**  to set values for *diS2* and *out2*, or press **Menu**  to exit and return to Run Mode.

---

#### Note

For instructions on how to program numeric values, see Setting numeric values (Page 27).

---

The Analog Output menu is also used to program the Sensor break value in mA.

















## Program sensor break output value (SEbr)

The sensor break value corresponds to the output signal generated when the meter detects a sensor break for thermocouple and RTD inputs.

For example, if there is an open thermocouple, the meter displays the message open and the analog output goes to the programmed sensor break value (e.g. 3.00 mA).

The sensor break value can be programmed from 0.00 to 23.99. The typical output signal range is 1.00 to 23.00 mA. For example, if the sensor break value is programmed to 0.00, the actual output will not be greater than 1.00 mA.

1. Press and hold **Right** arrow  and **Menu**  for three seconds to access Advanced Features menu of the meter.
2. Press **Up**  arrow until the *SELC* menu is displayed. Press **Ent/Ack**  to accept.
3. Press **Up**  arrow until the *out* menu is displayed. Press **Ent/Ack**  to accept.
4. Press **Up**  arrow until the *Aout* menu is displayed. Press **Ent/Ack**  to accept.
5. Press **Enter/Ack**  to access the scale menu.
6. Press **Up** arrow  until *sEbr* is displayed. Press **Ent/Ack**  to access the Sensor Break menu.
7. Press **Up** arrow  to change digit and **Right** arrow  to change active digit.
8. Press **Enter/Ack**  to accept setting.
9. Press **Menu**  to exit and return to Run Mode.

## Analog output when display is out of range

The analog output reflects the display out of range conditions as follows:

Input Condition	Display	Analog Output
Underrange	Flashing -1999	3.00 mA
Overrange	Flashing 9999	21.00 mA
Open TC or RTD	Flashing open	Sensor break value

## Programming the meter (ProG)

---

### Note

The meter is **factory calibrated** prior to shipment, for all input types, in milliamps, volts, and degrees respectively. The calibration equipment is certified to NIST standards.

---

The Program menu contains Calibrate and the Scale menus.

Process inputs may be calibrated or scaled to any display within the range of the meter.

Use the Scale menu to scale process inputs (such as 4 to 20 mA). A calibrated signal source is not needed to scale the meter.

For thermocouple and RTDs, simply connect the sensor to the proper terminals and apply power to the device. **No calibration needed!** (when the meter is first received from the factory).

Additional parameters, not needed for most applications, are programmed with the Advanced features menu. See Advanced Features (Page 47).

## Scaling the 4 to 20 mA analog input (ScAL)

The process inputs (4 to 20 mA and  $\pm 10$  V DC) can be scaled to display the process in engineering units.

A signal source is not required to scale the meter; simply program the inputs and corresponding display values.









---

### Note

The Scale menu is not available for temperature inputs.

---

### Scale the meter without a signal source:

1. Press **Menu**  to enter Program Mode.
2. Press **Up**  arrow until *ProG* appears in the display.
3. Press **Enter/Ack**  to access Programming functions. *ScAL* is displayed.
4. Press **Enter/Ack**  ; *inP1* is displayed.
5. Press **Enter/Ack**  to access scale adjustment for input 1.
6. Press **Up** arrow to change the digit and the **Right** arrow  to advance to the next digit.
7. Press **Enter/Ack**  to accept the displayed setting; *diS1* is displayed.
8. Press **Enter/Ack**  to change the display for display 1.
9. Change display using the technique described in steps 7-8.
10. Repeat steps 6 to 10 for the second input value.
11. Press **Enter/Ack**  to confirm settings and return to Run Mode.

---

### Note

For instructions on how to program numeric values. See Setting numeric values (Page 27).

---

### Error message (Err)

An error message indicates that the calibration or scaling process was not successful.

After the error message is displayed, the meter reverts to input 1, allowing the appropriate input signals to be applied.

The error message might be caused by any of the following conditions:

- Input signal is not connected to the proper terminals or it is connected backwards
- Wrong signal selection in Setup menu
- Minimum input span requirements not maintained
- Input 1 signal inadvertently applied to calibrate input 2.

### Minimum input span

The minimum input span is the minimum difference between input 1 and input 2 signals required to complete the calibration or scaling of the meter.

Input range	Input 1 and input 2 span
4 to 20 mA	0.40 mA
±10 VDC	0.20 VDC
TC	100°F (56°C)
RTD	50°F (28°C)

### Calibrating the SITRANS RD200 (CAL)











Recalibration is recommended at least every twelve months.

The meter can be calibrated to display the process in engineering units by applying the appropriate input signal and following the calibration procedure.

The use of a calibrated signal source is strongly recommended to calibrate the meter.

To scale the meter without a signal source refer to Scaling (Page 40).

#### Calibrate the meter with a signal source:

1. Press **Menu**  to enter Program Mode.
2. Press **Up**  arrow to scroll through choices.
3. When *ProG* is displayed, press **Enter/Ack** .
4. Press **Up** arrow  until **CAL** is displayed. Press **Enter/Ack**  to enter Calibrate Menu. *InP1* will be displayed.
5. Select input 1 value from signal source, then press **Enter/Ack** . Display will flash accepting input. *diS1* will be displayed.
6. Press **Enter/Ack** .
7. Press **Up** arrow  to change active digit and press **Right** arrow to advance to the next digit.
8. Press **Enter/Ack**  to accept display settings. *InP2* will be displayed.
9. Select input 2 value from signal source, then press **Enter/Ack** . Display will flash accepting input.
10. Repeat steps 6 to 8 for second input and display values.
11. Press **Enter/Ack**  to confirm settings and return to Run Mode.

## Recalibrating temperature inputs (CAL)

The Calibration (CAL) menu is used to **recalibrate** the thermocouple and RTD inputs.

---

### Note

Allow at least 30 minutes warm-up time before performing recalibration procedure to ensure specified accuracy.

---

### Recommended Calibration Points

To recalibrate the meter, it is recommended to use the Fahrenheit scale; this will give a greater degree of accuracy to the calibration. The scale can be changed to the Celsius scale after calibration is completed. The meter will display temperature accurately in any scale. The following table shows the recommended low and high calibration points for all types.

Type of input	Input 1 (Low)	Input 2 (High)	Check (Middle)
Type J T/C	32°F	1182°F	600°F
Type K T/C	32°F	1893°F	960°F
Type T T/C	32°F	693°F	360°F
Type T T/C	32.0°F	693.0°F	360.0°F
Type E T/C	32°F	1652°F	840°F
100 Ω RTD (0.00385)	32°F100Ω	1148°F320.12Ω	590°F215.61Ω
100 Ω RTD (0.00392)	32°F100Ω	1127°F320.89Ω	580°F215.87Ω

1. Connect signal to the meter using the appropriate wire (for example, type J thermocouple wire to recalibrate type J input). See Thermocouple and RTD connections (Page 18).
2. Set up the meter to accept the selected input (such as type J T/C). See Setting decimal point (Page 28).
3. Set up the meter to display temperature in degrees Fahrenheit. See Setting decimal point (Page 28).
4. Apply signal corresponding to input 1 (32°F) and program display 1 to 32. See "Recommended calibration points" above.
5. Apply signal corresponding to input 2 (1182°F for type J) and program display 2 accordingly. See "Recommended calibration points" above.

After the meter accepts input 2, the display flashes the message CJr that indicates the meter is sensing the cold junction reference. This completes the recalibration procedure for the selected input.

### Recalibrating process inputs (ICAL)

The Internal Calibration (ICAL) menu, located in the Advanced features menu, is used to recalibrate the current and voltage inputs. Recalibration is recommended at least every twelve months.







Refer to Meter cloning instructions (Page 55) for instructions.

## 6.6 Security

### Locking the meter by setting a password (PASS)

The Password menu is used to program a four-digit password to prevent unauthorized changes to the programmed parameter settings.

#### Setting up a password

1. From Run mode, press **Menu**  to enter Program Mode.
2. Press **Up** arrow  until *PASS* is displayed.
3. Press **Enter/Ack**  to enter password menu. unLC is displayed.
4. Press **Enter/Ack**  to set password.
5. Set a four-digit password by pressing **Up** arrow  to change digits and **Right** arrow to change active digit. (For instructions on how to program numeric values see Setting numeric values (Page 27))
6. Press **Enter/Ack**  to accept password settings. Program settings are now protected against unauthorized changes.

Record the password for future reference. If appropriate, it may be recorded in the space provided.

Model:	
Serial Number:	
Password:	_____



### 6.6.1 Unlocking the meter (unLC)

If the meter is password protected, the correct password must be entered in order to change parameters.

Entering the correct four-digit number sets the password to 0000, disabling protection.

Changes to the programmed parameter settings are allowed only with the password set to 0000.

#### To remove the password and unlock the meter:

1. From Run mode, press **Menu**  to enter Program Mode.
2. Press **Up** arrow  until *PASS* is displayed.
3. Press **Enter/Ack**  and enter previously set password. *unLC* is displayed and meter returns to Run mode.

Changes to programmed settings are now allowed.

If the password entered is incorrect, the meter displays *LoCd* (Locked) for about two seconds, then it returns to Run Mode.

To try again, press **Enter/Ack**  while the Locked message (*LoCd*) is displayed.

---

#### Note







##### Forgot the Password?

The password may be disabled by the following procedure:

1. Note the display reading prior to pressing the Menu button.
  2. Ignore decimal point and sign.
  3. Access the Password menu, add 2 to the noted reading and enter that number as the password (for example, display reading = -1.23, password=0125).
- 

## 6.7 Advanced Features

To simplify the setup process, functions not needed for most applications are located in the Advanced features menu.

1. Press and hold **Right**  arrow and **Menu**  for three seconds to access Advanced Features menu of the meter.
2. Press **Up** arrow  to scroll through the following menus and to increment digit values.
3. Press **Ent/Ack**  to access a menu or to accept a setting.
4. Press **Right** arrow  to select the next digit.
5. Press **Menu**  to exit at any time.

## Advanced features menu and display messages

Display	Parameter	Action/Setting
Adj	Adjust	Set offset adjustment for temperature <b>Not available for process inputs</b>
FLtr	Filet	Set noise filter value
byPS	Bypass	Set filter bypass value
SErL	Serial	Set serial communication parameters
Prot	Protocol	Enter the Protocol menu
PdC	PDC	Select PDC protocol
mbs	Modbus	Select Modbus protocol
Addr	Address	Set meter address
bAud	Baud rate	Select baud rate
trdE	Transmit delay	Set transmit delay for serial communication
prty	Parity	Select none, even, or odd (Modbus only)
tbyt	Byte-to-byte	Program byte-to-byte timeout (silent time – Modbus only)
CoPy	Copy	Enter copy function
SEnd	Send	Send meter settings to another meter
donE	Done	Copy function completed
SElc	Select	Enter the Select menu (function, cutoff, out)
Func	Function	Select linear or square root function
Linr	Linear	Set meter for linear function
Sqrt	Square root	Set meter for square root extraction
cutF	Cutoff	Set low-flow cutoff
out	Output	Set meter for either relay or analog output (factory set only - corresponding option installed)
inty	Intensity	Select display intensity
Aout	Analog output	Set meter for analog output option
rELy	Relay	Set meter for relay option
ICAL	Initial calibration	Enter initial calibration <b>Available for process inputs only</b>
Curr	Current	Calibrating current input
I Lo	I low	Calibrate low current input
I Hi	I high	Calibrate high current input
volt	Volt	Calibrate voltage input
VLo	V low	Calibrate low voltage input
VHi	V high	Calibrate high voltage input
diAG	Diagnostics	Display parameter settings
LEd	LED	Test display
CJC	CJC	Display cold junction compensation voltage
CFG	CFG	Display meter configuration
PtS	Points	Display calibration points for process inputs
rELy	Relays	Display relay settings
Aout	Analog output	Display analog output settings
GoFF	Gain/offset	Display gain and offset for process inputs











SErL	Serial	Display serial communication settings
InFo	Information	Display software version and S/N information

**Note**

For instructions on how to program numeric values see Setting numeric values (Page 27).

### 6.7.1 Offset adjustment

This parameter allows the user to select an offset adjustment to the temperature being displayed. Offset adjustment values can be either positive or negative and can be any number within  $\pm 19.9^\circ$ . The offset adjustment value is programmed through the Adjust menu.

1. Press and hold **Right** arrow  and **Menu**  for three seconds to access Advanced Features menu of the meter.
2. Press **Up** arrow  to scroll through the Advanced Features Menu options. When the Adjustment menu (Adj) is displayed, press **Enter/Ack**  to access the menu.
3. Press **Up** arrow  to change the active digit and press **Right** arrow  to advance to the next digit.
4. Press **Enter/Ack**  to accept display setting.
5. Press **Menu**  to exit at any time.

The offset adjustment feature can be useful to compensate for errors due to thermocouple junctions or excessive lead wire resistance in RTDs.

The offset adjustment value is automatically reset to zero whenever the type of temperature sensor is changed (i.e. Thermocouple type or RTD curve).

Celsius/Fahrenheit conversion of the offset adjustment value is automatic. See notes below for important limitations.

**Note**

- Offset adjustment is available only when TC or RTD input is selected.
- If adjustment value is greater than  $11^\circ\text{C}$  and the temperature scale is changed to Fahrenheit, the maximum applied adjustment will be  $19.9^\circ\text{F}$ .

## Noise filter (Fltr)









Most applications do not require changing this parameter. It is intended to help attain a steady display with an unsteady (noisy) input signal.

The field selectable noise filter averages any minor or quick changes in the input signal and displays the reading with greater stability.

Increasing the filter value will help stabilize the display, but this will reduce the display response to changes on the input signal.

The filter level may be set anywhere from 2 to 199.

Setting filter value to zero disables filter function, and bypass setting becomes irrelevant.

1. Press and hold **Right** arrow  and **Menu**  for three seconds to access Advanced Features menu of the meter.
2. Press **Up** arrow  to scroll through the Advanced Features Menu options.  
When the Filter menu (*FLtr*) is displayed, press Ent/Ack  to access the menu.
3. Press **Up** arrow  to change the active digit and press **Right** arrow  to advance to the next digit.
4. Press **Ent/Ack**  to accept display setting.
5. Press **Menu**  to exit at any time.







### 6.7.2 Noise filter bypass (bYPS)

The meter can be programmed to filter small input changes, but allow larger input changes to be displayed immediately, by setting the bypass value accordingly.

If the input signal goes beyond the bypass value, it will be displayed immediately with no averaging done on it.

The noise filter bypass value may be set anywhere from 0.2 to 99.9. It corresponds to percentage of full scale for process inputs and to degrees Fahrenheit for temperature inputs.

Increasing the bypass value may slow down the display response to changes on the input signal.

1. Press and hold **Right** arrow  and **Menu**  for three seconds to access Advanced Features menu of the meter.
2. Press **Up** arrow  to scroll through the Advanced Features Menu options.  
When the Bypass menu (*bYPS*) is displayed, press **Ent/Ack**  to access the menu.
3. Press **Up** arrow to change the active digit and press **Right** arrow  to advance to the next digit.
4. Press **Ent/Ack**  to accept display setting.
5. Press **Menu**  to exit at any time.

### 6.7.3 Serial communications (SErL)











The meter is equipped with serial communications capability as a standard feature using PDC Serial Communication Protocol. The Modbus® RTU protocol is standard on RD200.

To communicate with a computer or other data terminal equipment, an RS-232 or RS-422/485 adapter option is required.

When using more than one meter in a multi-drop mode, each meter must be provided with its own unique address. The address may be programmed from 00 to 99 for PDC protocol and from 1 to 247 for Modbus protocol.

The Protocol selection menu (*Prot*) is used to select either the PDC or the Modbus protocol.

The transmit delay may be set between 0 and 199 ms. Use the Serial menu (SErL) to set the protocol, address, baud rate, and transmit delay.

1. Press and hold **Right** arrow  and **Menu**  for three seconds to access Advanced Features menu of the meter.
2. Press **Up** arrow  to scroll through the Advanced Features Menu options. When the Serial menu (SErL) is displayed, press **Ent/Ack**  to access the menu.
3. Use **Up** arrow  to scroll between serial selection menus; protocol (*Prot*), address (*Addr*), baud rate (*bAud*) and transmit delay (*trde*).
4. Press **Ent/Ack**  to access the desired menu.
5. Press **Up** arrow  to scroll through options or to change active digit and press **Right** arrow  to advance to the next digit.
6. Press **Enter/Ack**  to accept display settings.
7. Press **Menu**  to exit at any time.

SITRANS RD200 can also be connected directly to another RD200 meter through a cable assembly (SITRANS RD200 Meter Copy Cable). This allows the user to copy all the settings from one meter to another, using the Copy function. See Meter copy function (Page 53).

See SITRANS RD Serial Adapters Instruction Manual for more details.

### Select menu (SELC)







The Select menu (*SELC*) is used to select linear (*Linr*) or square root (*Sqrt*) function, display intensity (*inty*), and low-flow cutoff (*cut F*). Selection for relay or analog output (*out*) is a factory setting depending on the option installed.

 <b>WARNING</b>
<b>Erroneous operation</b>
Output options are installed and set up at the factory. Changing the output selection ( <i>out</i> ) will cause erroneous operation of the meter. Do not change output selection.

### Linear or square root function (Linr or Sqrt)

Meters are set up at the factory for linear function. The linear function provides a display that is linear with respect to the input signal.











The square root function is used to linearize the signal from a differential pressure transmitter and display flow rate in engineering units.

1. Press and hold **Right** arrow  and Menu for three seconds to access Advanced Features menu of the meter.
2. Press **Up** arrow  to scroll through the Advanced Features Menu options. When the Select menu (*SELc*) is displayed, press **Ent/Ack**  to access the menu.
3. Press **Ent/Ack**  to access the Function menu (*Func*).
4. Use **Up** arrow  to scroll between function selections; Linear (Linr) and Square Root (*Sqrt*).
5. Press **Ent/Ack**  to accept the desired display setting.
6. Press **Menu**  to exit at any time.

### Low-flow cutoff (cut F)









The low-flow cutoff feature allows the meter to be programmed so that the often unsteady output from a differential pressure transmitter, at low flow rates, always displays zero on the meter.

The cutoff value may be programmed from 0 to 9999. Below the cutoff value, the meter will display zero. Programming the cutoff value to zero disables the cutoff.

1. Press and hold Right arrow  and Menu  for three seconds to access Advanced Features menu of the meter.  
Press Up arrow  to scroll through the Advanced Features Menu options.  
When the Select menu (*SELc*) is displayed, press Ent/Ack  to access the menu.
2. Press the Up  arrow until the Cut F menu is displayed. Press Ent/Ack  to access the Cutoff menu.
3. Press Up arrow  to change the active digit and press Right arrow  to advance to the next digit.
4. Press Ent/Ack  to accept display setting.
5. Press Menu  to exit at any time.

## Display intensity (intY)

The Display Intensity function allows the selection of eight levels of intensity for various lighting conditions.

1. Press and hold **Right** arrow  and **Menu**  for three seconds to access Advanced Features menu of the meter.
2. Press **Up** arrow  to scroll through the Advanced Features Menu options. When the Select menu (SELC) is displayed, press **Ent/Ack**  to access the menu.
3. Press **Up** arrow  until Intensity menu (*inty*) is displayed.
4. Press **Ent/Ack**  to access the intensity setting.
5. Press **Up** arrow  to scroll through the eight intensity levels. When the desired intensity level is displayed, press **Ent/Ack**  to accept the setting.
6. Press **Menu**  to exit at any time.

### 6.7.4 SITRANS RD Software

SITRANS RD software allows the SITRANS RD200 to be programmed from a PC and to act as a data logger.

The software allows all setup parameters to be saved to a file for reporting, restoring, or programming other meters.

---

#### Note

PDC protocol must be selected to communicate with SITRANS RD Software. See SITRANS RD Software Instruction Manual for more details.

---

### 6.7.5 Meter copy function

The Copy function (CoPy ) is used to copy (or clone) all the settings from one meter to other meters requiring exactly the same setup and programming (such as, type of input, scaling, decimal point, filter, bypass, etc.).

### Meter Copy Connection

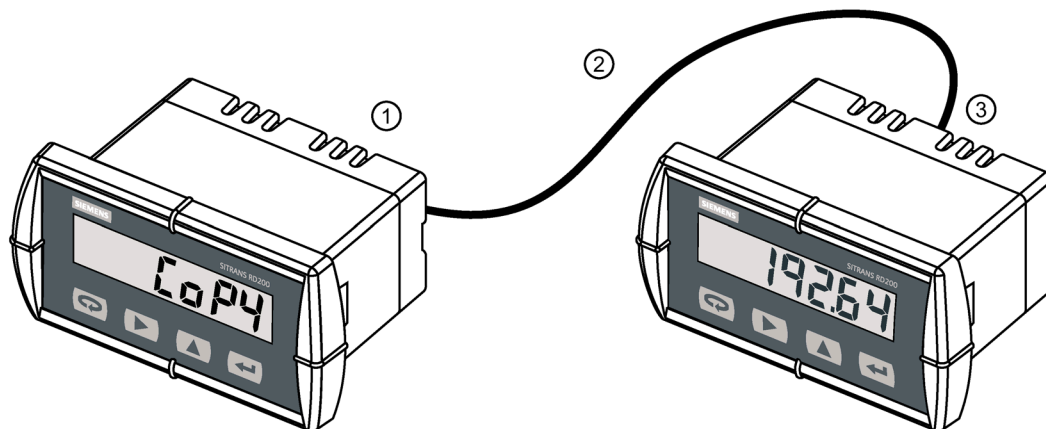

- ① master
- ② cable assembly
- ③ clone

---

#### Note

##### Copy function requirements

To successfully copy settings from one meter to another, both meters must have:

- Same software version
- Same baud rate setting
- PDC protocol selected

See Determining software version (Page 58).





---

## 6.7.6 Meter cloning instructions



### CAUTION

Do not connect the two meters to the same 4 to 20 mA loop while cloning. Internal calibration may be affected.

1. Connect the two meters using SITRANS RD200 meter copy cable or equivalent. Cable should not exceed 2.1 m (7 ft).
2. Power up both meters. Leave Clone meter in Run Mode.
3. Press and hold **Right** arrow  and **Menu**  for three seconds to access Advanced Features menu of the meter.
4. Press **Up** arrow  to scroll through the Advanced Features Menu options. When the Copy menu (*CoPy*) is displayed, press **Ent/Ack**  to access the menu.
5. The master meter displays the message *SEnd*. Press **Enter/Ack** . The display (*SEnd*) flashes indicating that the settings from the master meter are being copied to the clone meter. The message *donE* is briefly displayed when copying is completed.
6. *SEnd* is once again displayed on the master meter, indicating meter is ready to send settings to another meter.

During the copy, the Clone meter displays the memory address being programmed then the message *donE* when copying is completed. The clone meter initializes and returns to Run Mode using the same settings as the master.

If the clone meter does not respond to the data being sent, refer to "Copy function requirements" above.

## Internal calibration (ICAL)

---

**Note**

- The meter is factory calibrated prior to shipment, for all input types, in milliamps, volts and degrees respectively.
  - The calibration equipment is certified to NIST standards.
- 

The internal calibration allows the user to scale the meter without applying a signal. This menu is not available if the meter is set up for TC or RTD inputs.

The use of calibrated signal sources is necessary to perform the internal calibration of the meter.





Check calibration of the meter at least every 12 months. Each input type must be recalibrated separately, if meter will be used with all input types.

---



**Note**

- If meter is in operation and it is intended to accept only one input type (such as 4 to 20 mA), recalibration of other inputs is not necessary.
  - Allow the meter to warm up for at least 15 minutes before performing the internal calibration procedure.
- 

The Internal calibration menu is part of the Advanced features menu.

1. Press and hold **Right** arrow  and **Menu**  for three seconds to access Advanced Features menu of the meter.
2. Press **Up** arrow  to scroll to the Internal calibration menu (*ICAL*) and press **Enter/Ack** .
3. The meter displays either current (*Curr*) or voltage (*volt*), according to the meter input setup. Press **Enter/Ack**  to start the calibration process.



**Example for current (*Curr*) input internal calibration:**

1. The meter displays the low input calibration (*lLo*). Apply the low input signal and press **Enter/Ack** . The display flashes for a moment while meter is accepting the low input.
  2. After the display stops flashing, a number is displayed with the leftmost digit brighter than the rest. The bright digit is the active digit that can be changed by pressing **Up** arrow . Press **Right** arrow  to move to the next digit.
- 

**Note**

For instructions on how to program numeric values see Setting numeric values (Page 27).

---

3. Set the display value to correspond to the input signal being calibrated. Press **Ent/Ack**  to accept the display setting. The display moves to the high input calibration (*lHi*). Apply the high input signal in the same way that the low input signal was set in steps 1-3.
4. Press **Menu**  to exit at any time.



The example above shows the calibration of the current input. The voltage input is calibrated in a similar way.

---

**Note**

- Low and high input signals can be any valid values within the range of the meter.
  - Observe minimum input span requirements between input 1 and input 2.
  - Low input must be less than high input signal.
- 

**Error Message (Err)**

An error message indicates that the calibration or scaling process was not successful.

After the error message is displayed, the meter reverts to input 1, allowing the appropriate input signals to be applied.

The error message might be caused by any of the following conditions:

- Input signal is not connected to the proper terminals, or it is connected backwards.
- Wrong signal selection in Setup (SEtu) menu.
- Minimum input span requirements not maintained.

**Minimum Input Span**

The minimum input span is the minimum difference between input 1 and input 2 signals required to complete the calibration or scaling of the meter.

Input Range	Input 1 and input 2 span
4-20 mA	0.40 mA
±10 VDC	0.20 VDC







## 6.7.7 Troubleshooting

The rugged design and the user-friendly interface of the meter should make it unusual for the installer or operator to refer to this section of the manual.

If the meter is not working as expected, refer to the Diagnostics menu and recommendations below. See also Troubleshooting tips (Page 62).

### Diagnostics menu (diAG)





The diagnostics menu provides an easy way to view the programmed parameter settings for troubleshooting purposes.

1. Press and hold **Right** arrow  and **Menu**  for three seconds to access Advanced Features menu of the meter.
2. Press **Up** arrow  to scroll to the Diagnostics menu (*diAG*) and press **Enter/Ack**  to access this menu.
3. Press **Up** arrow  to scroll through the various menus.
4. Press **Enter/Ack** button  to access a displayed menu and **Menu** button  to exit at any time.

For a description of the diagnostics messages see Advanced Features (Page 47).

### 6.7.8 Determining software version





#### To determine the software version of a meter

1. Go to the Diagnostics menu (diAG) and press **Enter/Ack**  button .
2. Press **Up** arrow  and scroll to the Information menu (Info).
3. Press **Enter/Ack**  to access the software number (*SFT*), version (*VER*), and serial number (*Sn*) information. Write down the information as it is displayed. Continue pressing **Enter/Ack** until all the information is displayed.
4. Press **Menu**  to exit at any time.

For process inputs, the meter is capable of accepting positive and negative signals and displaying these signals in engineering units from -1999 to 9999 (for example, a signal from -10 to +10 VDC could be displayed as -10.00 to 10.00).

The temperature inputs are displayed according to the input type and temperature units (°F or °C) selected. Type T thermocouples can be displayed with either 1° or 0.1° resolution.







## 7.1 Front Panel Buttons Operation

Button Symbol	Description
	Press to enter or exit Programming Mode, view settings, or exit Max/Min readings.
	Press to reset Max/Min readings.
	Press to display Max/Min readings alternately.
	Press to display Max/Min reading indefinitely while displaying Max/Min. Press ACK to acknowledge relays.

## 7.2 Maximum/Minimum readings





The main function of the front panel buttons during operation is to display the maximum and minimum readings reached by the process or temperature inputs.

### Display maximum and minimum values

1. From Run mode, press **Up** arrow  to display maximum reading since the last reset/power-up. Display will alternate between *Hi* and maximum value for 10 seconds.
2. Press **Up** arrow  again to display the minimum reading since the last reset/ power-up. Display will alternate between *Lo* and minimum value for 10 seconds.
3. Press **Enter/Ack**  to continuously display Max/Min display reading. This will disable the 10-second time-out. The meter will continue to track new Max/Min readings.  
If **Enter/Ack**  is not pressed, the Max/Min display reading will timeout after ten seconds and the meter will return to display the actual reading.
4. Press **Right** arrow  to reset Max/Min while reading is being displayed. Max/ Min display readings are reset to actual reading.
5. Press **Menu**  to exit Max/Min display.

## Factory defaults

### To load factory defaults:

1. Press and hold **Right** arrow  and Menu  for three seconds to access Advanced Features menu of the meter.
2. Press **Up** arrow  to scroll to the Diagnostics menu (diAG).
3. Press and hold **Right** arrow  until rSET flashes (about 5 seconds). While rSET is flashing, press **Enter/Ack**  to reset the meter to factory defaults.

---

### Note

If **Enter/Ack**  is not pressed within three seconds, the display returns to the Diagnostics menu without resetting the meter.

---

When **Ent/Ack**  is pressed within three seconds, the meter goes through an initialization sequence (same as on power-up), and loads the factory default settings.

## A.1 Factory defaults and user settings

The following table shows the factory setting for most of the programmable parameters on the meter. Record the new settings for your particular application in the User Setting column of the Parameter Table below. (SITRANS Remote Display software allows the saving of all meter parameters to a file for restoring meter settings, reporting, and copying settings to other meters. See SITRANS Remote Display Software Instruction Manual for more details.)

Model: \_\_\_\_\_ S/N: \_\_\_\_\_ Date: \_\_\_\_\_

Display	Parameter	Default Setting	User Setting
inPt	Input type	4-20 mA	
ProG	Programming	Scale	
inP1	Input 1	4.00 mA	
diS1	Display 1	4.00	
inP2	Input 2	20.00 mA	
diS2	Display 2	20.00	
dd.dd	Decimal point	2 places	
rLY1	Relay 1		
Act1	Action 1	Automatic	
SEt1	Set 1	7.00	
rSt1	Reset 1	6.00	
rLY2	Relay 2		
Act2	Action 2	Automatic	
SEt2	Set 2	10.00	

Display	Parameter	Default Setting	User Setting
rSt2	Reset 2	9.00	
FLSF	Fail-safe		
FLS1	Fail-safe 1	Off	
FLS2	Fail-safe 2	Off	
dLAy	Time delay		
On1	On delay 1	0 sec	
OFF1	Off delay 1	0 sec	
On2	On delay 2	0 sec	
OFF2	Off delay 2	0 sec	
PASS	Password	0000 (unlocked)	
<b>Advanced Features</b>			
Adj	Adjust	0.0° (temp only)	
FLtr	Filter	10	
byPS	Bypass	0.2	
SERL	Serial settings		
PdC	Protocol	PDC protocol	
Addr	Address	00	
bAud	Baud rate	2400	
trdE	Trans delay	10 ms	
Func	Function	Linear	
Cut F	Cutoff value	0.00 (disabled)	
out	Output option	Factory set only	
inty	Display intensity	Level 2	
<b>Modbus Defaults</b>			
Addr	Address	247	
prty	Parity	Even	
tbyt	Byte-to-byte timeout*	0.01 sec	

\* The byte-to-byte timeout setting might be updated automatically depending on the baud rate selected and the previous timeout setting. The minimum timeout allowed is saved to memory if a lower value is entered (for example, if user enters 0.00 with a baud rate of 300, 0.06 is saved).

# B

## Troubleshooting tips

Symptom	Check/Action
No display at all	Check power at power connector
Not able to change setup or programming; <i>LoCd</i> is displayed	Meter is locked; enter correct four-digit password to unlock
Meter displays error message during calibration ( <i>err</i> )	Check: Signal connections Input selected in Setup menu Minimum input span requirements
Meter displays <i>open</i> 9999 -1999 Displays negative number, not responding to RTD.	Check: Input selected in Setup menu TC/RTD Switch position Corresponding signal at Signal connector
Display alternates between <i>Hi</i> and a number <i>Lo</i> and a number	Press <b>Menu</b>  to exit display readings.
Display response is too slow	Check filter and bypass values
Inaccurate temperature reading	Check: Temperature units (×F or ×C) TC type or RTD curve selected Offset adjustment TC wire used Calibration
If the display locks up or the meter does not respond at all	Cycle the power to restart the microprocessor.
Relay operation is reversed	Check: Fail-safe in Setup menu Wiring of relay contacts
Relay and status LED do not respond to signal	Check: Relay action in Setup menu Set and reset points
Meter not communicating with SITRANS Remote Display Software or other programs	Check: Serial adapter and cable Serial protocol selected Meter address and baud rate SITRANS Remote Display Software address and baud rate
Other symptoms not described above	Contact your local Siemens representative for assistance.

## Quick user interface reference guide

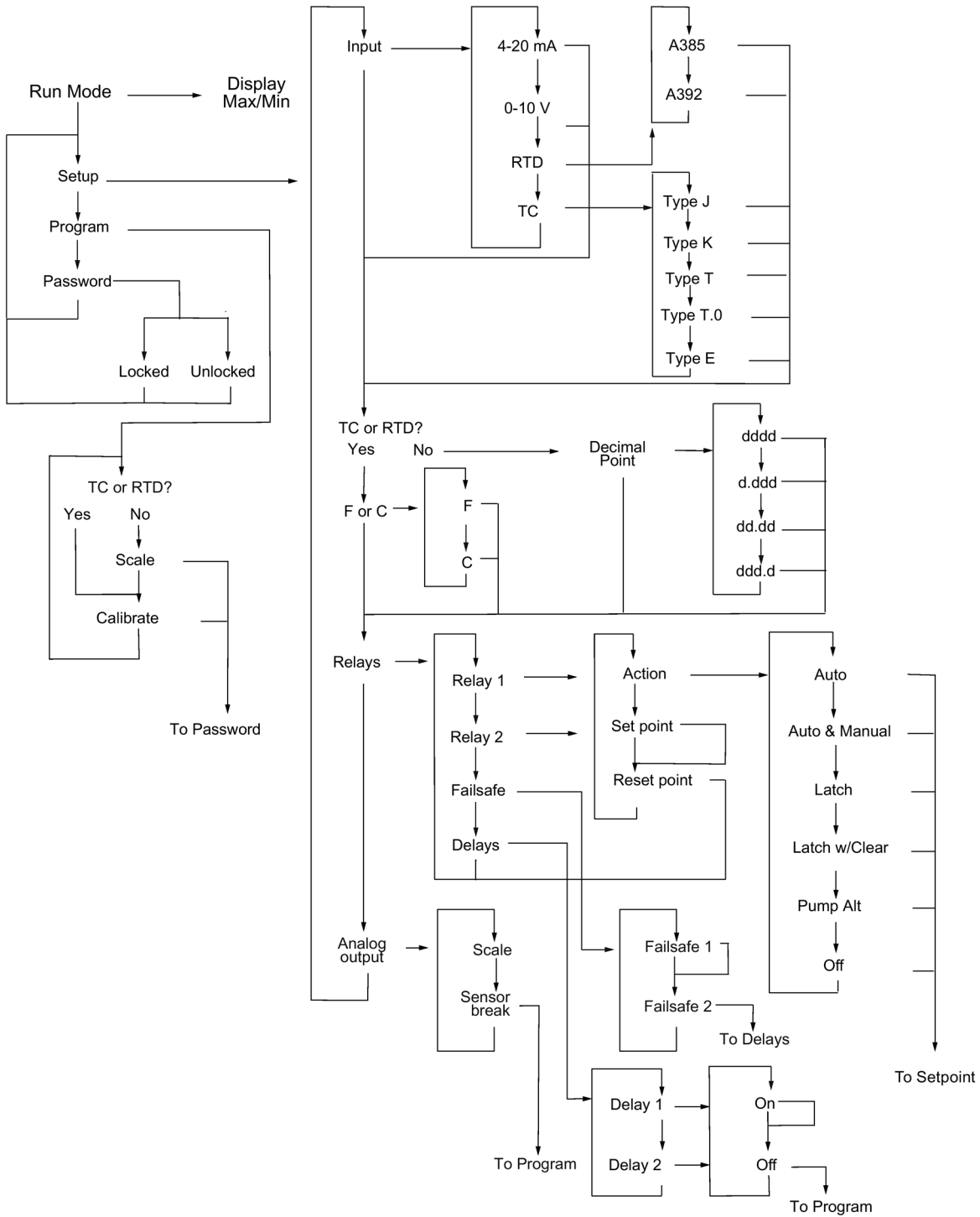

Pushbutton	Function
Menu	Go to Programming Mode or leave Programming, Advance Features, and Max/Min Modes.
Right Arrow	Move to next digit
Up Arrow	Move to next selection or increment digit
Right Arrow & Menu held for 3 seconds enters Advanced Features	

**Max/Min Mode**

While in Run Mode, pressing **Up Arrow** will initiate Max/Min Mode. **Up Arrow** toggles between Max & Min displays, and **Right Arrow** resets the Max/Min to the current value. Press **Menu** or wait 10 seconds to return to Run Mode. Pressing **Enter/Ack** will disable the 10 second timeout and continuously display Max or Min.

**Note**

Press & hold **Right** arrow and **Menu** for 3 seconds to access Advanced Features Menu

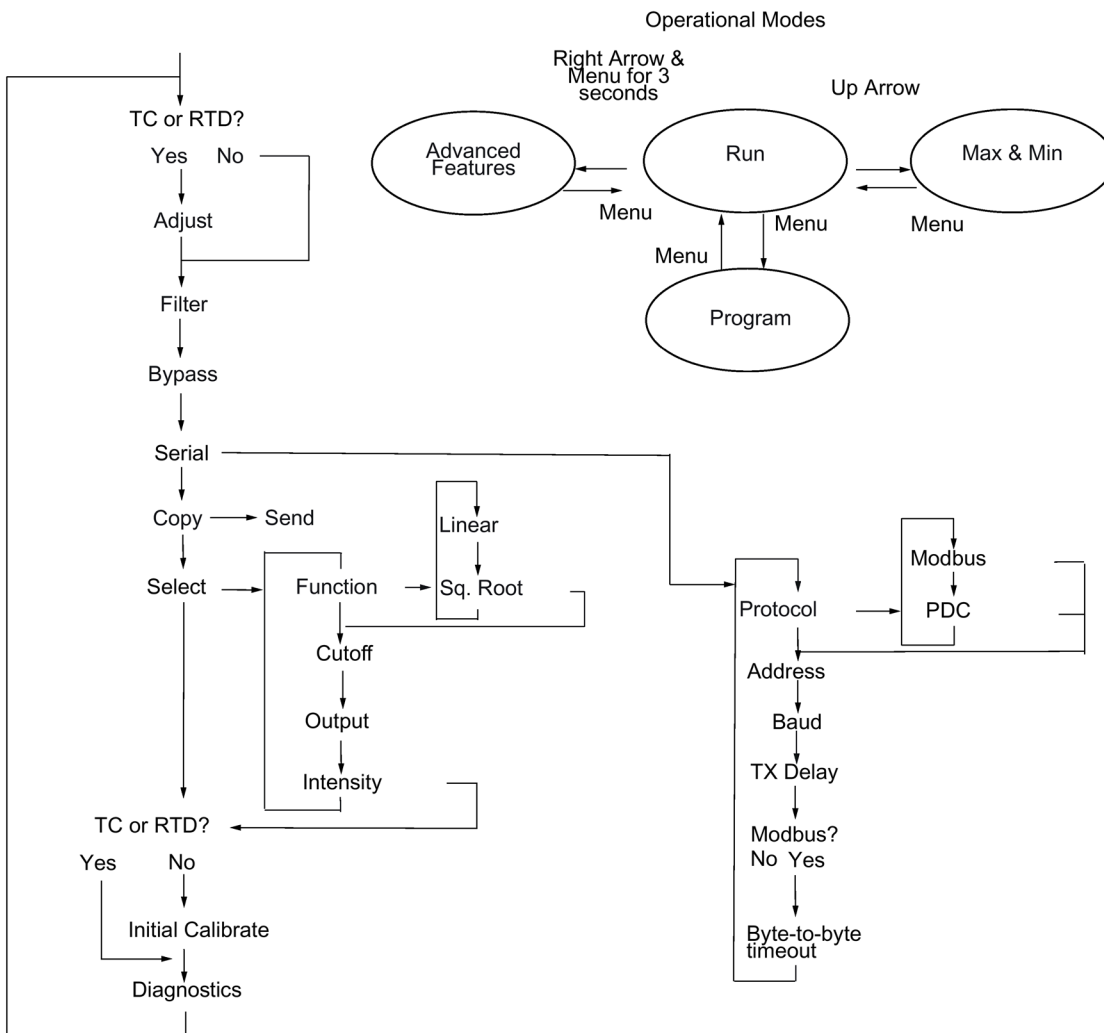



## Serial communication protocol

### SITRANS RD200 PDC

This section describes how to communicate with the SITRANS RD200 meter using the Serial Communication Protocol (PDC). The user should be familiar with serial communications and the meter. Refer to the instruction manuals for the meter and the serial communication adapters for setup and wiring instructions.

Serial communications uses 8 data bits, 1 start bit and 1 stop bit. Data is standard 7-bit ASCII, with the 8th bit ignored for received data and cleared for transmitted data.

Note that in this document, hex data is indicated by a "0x" prefix, ASCII characters are shown with single quotes, as in '8' (= 0x38), and ASCII strings are shown with double quotes, as in "SFT013".

To accommodate multiple devices sharing a common serial network (RS-485), there is a programmable address code. The address code is selected from the front panel or via serial command 38. Note that the address is required even for point-to-point configurations (RS-232 and RS-422).

All data transfers are initiated by a request from the host computer and completed by a reply from the meter. Multiple requests cannot be processed simultaneously. It is the responsibility of the host to wait at least 500 milliseconds after completing a request before assuming that the message was not received correctly.

## D.1 Table of Commands

Command Code	Description
10	Read Process Value
11	Read Maximum Process Value
12	Read Minimum Process Value
F0	Read Product Identifier
F1	Read Firmware Version
30	Reset the Maximum Process Value
31	Reset the Minimum Process Value
32	Initialize Meter
19	Display Intensity
20	Input Selection Parameters
21	Lockout Code
22	Filter Value
23	Bypass Value
23	Adjustment Value
26	Relay Set and Reset Points
27	Relay Operating Parameters
28	Relay Turn-Off and Turn-On Time Delay
29	Serial Transmission Time Delay
39	Relay Acknowledge
37	Current and Voltage Decimal Points
40	4-20 mA Out – Data
41	4-20 mA Out – Mode
42	4-20 mA Out – Filter
43	4-20 mA Out – Limits
44	4-20 mA Out – Input and Output points
47	Cutoff Value
48	Linear/Exponential Selection

## D.2 Command Packet Format

SOH (0x01)	Meter Address	Meter Address	Comm and Code	Comm and Code	Data (as reqd.)	Check- sum	Check- sum	ETX (0x03)
---------------	------------------	------------------	------------------	------------------	-----------------------	---------------	---------------	---------------

1. SOH (0x01) - Unconditional start of message character. Valid any time except while a reply is in progress.
2. Two character meter address code (00 - 99).
3. Two character command code.
4. Data or argument field(s) if required.
5. Two character ASCII hex checksum (0x00 – 0xFF) which represents the 8 bit result of the negative of the sum of all data characters in the command code and data fields. Parity bits are excluded from the calculation.

Checksum = 1 + not(Command Code[high] + Command Code[low] + any data or arguments)

6. ETX (0x03) - Terminator character.

Example: Read the set point for Relay #1 of meter 00:

Address: 00

Command Code: 26

Arguments: "S0". 'S' = Set point; '0' = Relay #1 (relay numbering starts with 0)

Checksum = 1 + not('2' + '6' + 'S' + '0')

= 1 + not(0x32 + 0x36 + 0x53 + 0x30)

= 1 + not(0xEB)

= 1 + 0x14

= 0x15

Therefore, the complete command packet that is sent = 0x01, "0026S015", 0x03 In hex form = 0x01 0x30 0x30 0x32 0x36 0x53 0x30 0x31 0x35 0x03

## D.3 Reply Packet Format

STX (0x02)	Command Code	Command Code	Data (as req'd.)	Check-sum	Check-sum	ETX (0x03)
---------------	-----------------	-----------------	---------------------	-----------	-----------	---------------

1. STX (0x02) - Start character.
2. Two character command code.
3. Data field if required.
4. Two character ASCII hex checksum (00 - FF), which represents the negative of the sum of all data characters in the command code and data fields.
5. ETX (0x03) - Terminator character.

All received data is thoroughly checked for errors. To prevent serial bus conflicts no reply is sent unless valid start and end characters and the proper address code are received. Invalid messages longer than 22 characters will result in a receive-buffer overflow and will not generate a reply. Normal operation resumes with the reception of the next start of message character.

To aid in the development of application software, certain syntax errors will result in replies containing special error codes in the command code field.

Error Code	Description
Z0	Message too short to be valid
Z1	Checksum error
Z2	Invalid command code
Z4	Incorrect amount of data in the data field
Z6	Invalid data in the data field
Z7	EEPROM write error

## D.4 Read only Commands

### Code: 10 Description: Read Process Value

Table D- 1 Command

SOH (0x01)	Meter Ad- dress	Meter Ad- dress	'1'	'0'	'9'	'F'	ETX (0x03)
------------	--------------------	--------------------	-----	-----	-----	-----	------------

Table D- 2 Reply

STX (0x02)	'1'	'0'	Relay Status	'U' 'O' 'P' '+' '-'	n	n	n	n	n	n	n	Check sum	Check sum	ETX (0x03)
---------------	-----	-----	-----------------	---------------------------------	---	---	---	---	---	---	---	--------------	--------------	---------------

The reply data is nine characters consisting of a relay status character, followed by 'U' (Under Range), 'O' (Over Range), 'P' (Open), '+', or '-' followed by a number string including a decimal point, if it is selected for display. The number string is always seven characters, consisting of either six digits and a decimal point, or six digits with a leading zero if no decimal point is selected. The Open character indicates an overrange condition for a temperature input. The relay status represents the energized or de-energized state of the relay(s), and is active low logic (status 0 = relay energized).

#### Relay Status Character

Relay 2	Relay 1	Hex character
On	On	0
On	Off	1
Off	On	2
Off	Off	3

D.4 Read only Commands

**Code: 11 Description: Read Maximum Process Value**

Table D- 3 Command

SOH (0x01)	Meter Ad- dress	Meter Ad- dress	'1'	'1'	'9'	'E'	ETX (0x03)
------------	--------------------	--------------------	-----	-----	-----	-----	------------

Table D- 4 Reply

STX (0x02)	'1'	'1'	'+' '-'	n	n	n	n	n	n	n	Check- sum	Check- sum	ETX (0x03)
------------	-----	-----	------------	---	---	---	---	---	---	---	---------------	---------------	------------

The reply data format is eight characters consisting of '+' or '-' followed by a number string. The number string is always seven characters, consisting of either six digits and a decimal point, or six digits with a leading zero if no decimal point is selected.

**Code: 12 Description: Read Minimum Process Value**

Table D- 5 Command

SOH (0x01)	Meter Ad- dress	Meter Ad- dress	'1'	'2'	'9'	'D'	ETX (0x03)
------------	--------------------	--------------------	-----	-----	-----	-----	------------

Table D- 6 Reply

STX (0x02)	'1'	'2'	'+' '-'	n	n	n	n	n	n	n	Check- sum	Check- sum	ETX (0x03)
------------	-----	-----	------------	---	---	---	---	---	---	---	---------------	---------------	------------

The reply data format is eight characters consisting of '+' or '-' followed by a number string. The number string is always seven characters, consisting of either six digits and a decimal point, or six digits with a leading zero if no decimal point is selected.

**Code: F0 Description: Read Product Identifier**

Table D- 7 Command

SOH (0x01)	Meter Address	Meter Address	'F'	'0'	'8'	'A'	ETX (0x03)
------------	---------------	---------------	-----	-----	-----	-----	------------

Table D- 8 Reply

STX (0x02)	'F'	'0'	'''	'S'	'F'	'T'	'0'	'1'	'3'	'''	'3'	'B'	ETX (0x03)
------------	-----	-----	-----	-----	-----	-----	-----	-----	-----	-----	-----	-----	------------

The reply data is eight characters consisting of a product identification string enclosed in quotation marks. An example is shown for "SFT013".

**Code: F1 Description: Read Firmware Version**

Table D- 9 Command

SOH (0x01)	Meter Ad- dress	Meter Ad- dress	'F'	'1'	'8'	'9'	ETX (0x03)
------------	--------------------	--------------------	-----	-----	-----	-----	------------

Table D- 10 Reply

STX (0x02)	'F'	'1'	''''	'0'	'1'	'.'	'2'	'3'	'4'	''''	'9'	'4'	ETX (0x03)
------------	-----	-----	------	-----	-----	-----	-----	-----	-----	------	-----	-----	------------

The reply data is eight characters consisting of the version code enclosed in quotation marks. An example is shown for "01.234"

**D.5 No-Data Commands****Code: 30 Description: Reset the Maximum Process Value**

Table D- 11 Command

SOH (0x01)	Meter Address	Meter Address	'3'	'0'	'9'	'D'	ETX (0x03)
------------	---------------	---------------	-----	-----	-----	-----	------------

Table D- 12 Reply

STX (0x02)	'3'	'0'	'9'	'D'	ETX (0x03)
------------	-----	-----	-----	-----	------------

**Code: 31 Description: Reset the Minimum Process Value**

Table D- 13 Command

SOH (0x01)	Meter Address	Meter Address	'3'	'1'	'9'	'C'	ETX (0x03)
------------	---------------	---------------	-----	-----	-----	-----	------------

Table D- 14 Reply

STX (0x02)	'3'	'1'	'9'	'C'	ETX (0x03)
------------	-----	-----	-----	-----	------------

**Code: 32 Description: Initialized Meter**

Table D- 15 Command

SOH (0x01)	Meter Address	Meter Address	'3'	'2'	'9'	'B'	ETX (0x03)
------------	---------------	---------------	-----	-----	-----	-----	------------

Table D- 16 Reply

STX (0x02)	'3'	'2'	'9'	'B'	ETX (0x03)
------------	-----	-----	-----	-----	------------

Initializes the meter in the following order:

1. Input configuration
2. Bypass and Filter values
3. Adjust value
4. Relay parameters (whether installed or not)
5. 4-20 mA output parameters (whether installed or not)
6. Serial parameters and address

There is no data in the reply.

**D.6 Read/Write Commands****Code: 19 Description: Display Intensity**

Table D- 17 Command: Read

SOH (0x01)	Meter Address	Meter Address	'1'	'9'	'9'	'6'	ETX (0x03)
------------	---------------	---------------	-----	-----	-----	-----	------------

Table D- 18 Command: Write

SOH (0x01)	Meter Address	Meter Address	'1'	'9'	'1' to '8'	Checksum	Checksum	ETX (0x03)
------------	---------------	---------------	-----	-----	------------	----------	----------	------------

Table D- 19 Reply: Write and Read

STX (0x02)	'1'	'9'	'1' to '8'	Checksum	Checksum	ETX (0x03)
------------	-----	-----	------------	----------	----------	------------

Read and write the LED display intensity: '8' is the brightest level.



**Code: 20 Description: Input Selection Parameters**

Table D- 20 Command: Read

SOH (0x01)	Meter Address	Meter Address	'2'	'0'	'9'	'E'	ETX (0x03)
------------	---------------	---------------	-----	-----	-----	-----	------------

Table D- 21 Command: Write

SOH (0x01)	Meter Address	Meter Address	'2'	'0'	X	X	X	X	Check-sum	Check-sum	ETX (0x03)
------------	---------------	---------------	-----	-----	---	---	---	---	-----------	-----------	------------

Table D- 22 Reply: Write and Read

STX (0x02)	'2'	'0'	X	X	X	X	Checksum	Checksum	ETX (0x03)
------------	-----	-----	---	---	---	---	----------	----------	------------

The data field is four ASCII hex characters representing a 16-bit value. These settings become effective only after an initialize command (Command 32) or a power down/power up cycle. Combinations other than those shown are reserved for future use and their use may result in improper operation.

Bits	Description
15 - 8	Input Selection
	00000000 Volts
	00010001 Current
	00100010
	00100011 (00110010 also valid, but Thermocouple 00100011 preferred)
7	Temperature Units
	0 Display temperature in °C
	1 Display temperature in °F
6 - 4	Volts or Current Decimal Point Selection (ignored for all other input selections)
	000 ddddd.
	001 ddddd.d
	010 dddd.dd
	011 ddd.ddd
	100 dd.dddd
	101 d.ddddd
	110 dddddd (no decimal)
	111 Not valid
3 - 0	Sensor Type
	0000 Type J thermocouple
	0001 Type K thermocouple
	0010 Type T thermocouple

D.6 Read/Write Commands

	0011 Type T thermocouple
	0100 Type E thermocouple
	0101 100 Ω Platinum RTD (385)
	0110 100 Ω Platinum RTD (392)

Example: To program meter 00 for Type J thermocouple in degrees F:

Command packet: = 0x01, "00202380D1", 0x03

In hex form = 0x01 0x30 0x30 0x32 0x30 0x32 0x33 0x38 0x30 0x44 0x31 0x03

**Note**

If the input selection is Thermocouple or RTD, the decimal point should be selected for 123456 (110), except for Type T thermocouple with 0.1° resolution, resolution is then set to 12345.6 (001).

**Description: Lockout Code**

Table D- 23 Command: Write only

SOH (0x01)	Meter Address	Meter Address	'2'	'1'	X	X	X	X	Check-sum	Check-sum	ETX (0x03)
------------	---------------	---------------	-----	-----	---	---	---	---	-----------	-----------	------------

Table D- 24 Reply

STX (0x02)	'2'	'1'	'9'	'D'	ETX (0x03)
------------	-----	-----	-----	-----	------------

The data field consists of a four-digit number, 0000 through 9999. For security reasons the code cannot be read. The reply is "21"

**Code: 22 Description: Filter Value**

Table D- 25 Command: Read

SOH (0x01)	Meter Address	Meter Address	'2'	'2'	'9'	'C'	ETX (0x03)
------------	---------------	---------------	-----	-----	-----	-----	------------

Table D- 26 Command: Write

SOH (0x01)	Meter Address	Meter Address	'2'	'2'	'+'	'0'	'0'	'0'	X	X	X	Check sum	Check sum	ETX (0x03)
------------	---------------	---------------	-----	-----	-----	-----	-----	-----	---	---	---	-----------	-----------	------------

Table D- 27 Reply: Write and Read

STX (0x02)	'2'	'2'	'+'	'0'	'0'	'0'	X	X	X	Check-sum	Check-sum	ETX (0x03)
------------	-----	-----	-----	-----	-----	-----	---	---	---	-----------	-----------	------------

The data field is 7 characters consisting of "+000" followed by the value. Valid values are 000, and 002 to 199.

**Code: 23 Description: Bypass Value**

Table D- 28 Command: Read

SOH (0x01)	Meter Address	Meter Address	'2'	'3'	'9'	'B'	ETX (0x03)
------------	---------------	---------------	-----	-----	-----	-----	------------

Table D- 29 Command: Write

SOH (0x01)	Meter Address	Meter Address	'2'	'3'	'+'	'0'	'0'	'0'	X	X	X	Check sum	Check sum	ETX (0x03)
------------	---------------	---------------	-----	-----	-----	-----	-----	-----	---	---	---	-----------	-----------	------------

Table D- 30 Reply: Write and Read

STX (0x02)	'2'	'3'	'+'	'0'	'0'	'0'	X	X	X	Check-sum	Check-sum	
------------	-----	-----	-----	-----	-----	-----	---	---	---	-----------	-----------	--

The data field is 7 characters consisting of "+000" followed by the value. The range is 002 to 999. Note that these values actually represent 0.2 to 99.9. The decimal point is implied.

**Code: 24 Description: Adjustment Value**

Table D- 31 Command: Read

SOH (0x01)	Meter Address	Meter Address	'2'	'4'	'9'	'A'	ETX (0x03)
------------	---------------	---------------	-----	-----	-----	-----	------------

Table D- 32 Command: Read

SOH (0x01)	Meter Address	Meter Address	'2'	'4'	'9'	'A'	ETX (0x03)
------------	---------------	---------------	-----	-----	-----	-----	------------

Table D- 33 Command: Write

SOH (0x01)	Meter Address	Meter Address	'2'	'4'	'+' '.'	'0'	'0'	'0'	X	X	X	Check-sum	Check-sum	ETX (0x03)
------------	---------------	---------------	-----	-----	------------	-----	-----	-----	---	---	---	-----------	-----------	------------

Table D- 34 Reply: Write and Read

STX (0x02)	'2'	'4'	'+' '.'	'0'	'0'	'0'	X	X	X	Check-sum	Check-sum	ETX (0x03)
------------	-----	-----	------------	-----	-----	-----	---	---	---	-----------	-----------	------------

The data field is 7 characters. The range is -199 to +199. Note that these values actually represent -19.9 to +19.9. The decimal point is implied.

**Code: 26 Description: Relay Set and Reset Points**

Table D- 35 Command: Read

SOH (0x01)	Meter Address	Meter Address	'2'	'6'	'S' 'R'	Relay #	Checksum	Checksum	ETX (0x03)
---------------	---------------	---------------	-----	-----	------------	---------	----------	----------	---------------

Table D- 36 Command: Write

SOH (0x01)	Meter Address	Meter Address	'2'	'6'	'S' 'R'	Relay #	'+' '-'	'0'	'0'	X	X	X	X	Check-sum	Check-sum	ETX (0x03)
---------------	---------------	---------------	-----	-----	------------	---------	------------	-----	-----	---	---	---	---	-----------	-----------	---------------

Table D- 37 Reply: Write and Read

STX (0x02)	'2'	'6'	'+' '-'	'0'	'0'	X	X	X	X	X	Check-sum	Check-sum	ETX (0x03)
---------------	-----	-----	------------	-----	-----	---	---	---	---	---	-----------	-----------	---------------

To read or write Reset Points, follow the command code with an 'R'. Use an 'S' for Set Points.

**Note**

Relay numbers start with zero, but in the meter instruction manuals, relay numbering starts with one.

The reply data format is eight characters consisting of '+' or '-' followed by a number string. The number string is always seven characters, consisting of either six digits and a decimal point, or six digits with a leading zero if no decimal point is selected. Note that the write command does not include the decimal point regardless of the decimal point setting.

**Code: 27 Description: Relay Operating Parameters**

Table D- 38 Command: Read

SOH (0x01)	Meter Address	Meter Address	'2'	'7'	Relay #	Checksum	Checksum	ETX (0x03)
------------	---------------	---------------	-----	-----	---------	----------	----------	------------

Table D- 39 Command: Write

SOH (0x01)	Meter Address	Meter Address	'2'	'7'	Relay #	'0'	'0'	Check- sum	Check- sum	ETX (0x03)
						'1'	'1'			
							'2'			
							'3'			
							'4'			
							'7'			

Table D- 40 Reply: Write and Read

SOH (0x01)	'2'	'7'	'0'	'0'	Checksum	Checksum	ETX (0x03)
			'1'	'1'			
				'2'			
				'3'			
				'4'			
				'7'			

Relay numbers start with zero. In the manuals, relay numbering starts with one.

The operating parameters consist of two digits, representing fail-safe and mode:

First Digit	Second Digit
0 - Fail Safe off	0 - Automatic Reset
1 - Fail Safe on	1 - Automatic and Manual Reset
	2 - Latched Operation
	3 - Latched Operation with Clear
	4 - Alternating Operation
	5 - Reserved. Do Not Use!
	6 - Reserved. Do Not Use!
	7 - Relay Disabled

**Code: 28 Description: Relay Turn-Off and Turn-On Time Delay**

Table D- 41 Command: Read

SOH (0x01)	Meter Address	Meter Address	'2'	'8'	'0' '1'	Relay #	Checksum	Checksum	ETX (0x03)
------------	---------------	---------------	-----	-----	------------	---------	----------	----------	------------

Table D- 42 Command: Write

SOH (0x01)	Me- ter Ad- dress	Me- ter Ad- dress	'2'	'8'	'0' '1'	Relay #	'+'	'0'	'0'	'0'	X	X	X	Check- sum	Check- sum	ETX (0x03)
------------	----------------------------	----------------------------	-----	-----	------------	------------	-----	-----	-----	-----	---	---	---	---------------	---------------	------------

Table D- 43 Reply: Write and Read

STX (0x02)	'2'	'8'	'+'	'0'	'0'	'0'	X	X	X	Check- sum	Check- sum	ETX (0x03)
------------	-----	-----	-----	-----	-----	-----	---	---	---	---------------	---------------	------------

To read or write Turn-Off Time Delay, follow the command code with a '0'. Use a '1' for Turn-On Time Delay. The delay number is "+000" followed by the value in seconds. The range is 000 to 199.

**Note**

Relay numbers start with zero, but in the meter instruction manuals, relay numbering starts with one.

**Code: 29 Description: Serial Transmission Time Delay**

Table D- 44 Command: Read

SOH (0x01)	Meter Address	Meter Address	'2'	'9'	'9'	'5'	ETX (0x03)
------------	---------------	---------------	-----	-----	-----	-----	------------

Table D- 45 Command: Write

SOH (0x01)	Meter Address	Meter Address	'2'	'9'	'+'	'0'	'0'	'0'	X	X	X	Check sum	Check sum	ETX (0x03)
------------	---------------	---------------	-----	-----	-----	-----	-----	-----	---	---	---	--------------	--------------	------------

Table D- 46 Reply: Write and Read

STX (0x02)	'2'	'9'	'+'	'0'	'0'	'0'	X	X	X	Check- sum	Check- sum	ETX (0x03)
------------	-----	-----	-----	-----	-----	-----	---	---	---	---------------	---------------	------------

The data field is 7 characters consisting of "+000" followed by the value in milliseconds. The range is 000 to 199.

**Code: 39 Description: Relay Acknowledge**

Table D- 47 Command:

SOH (0x01)	Meter Address	Meter Address	'3'	'9'	'0' '1' 'L'	Checksum	Checksum	ETX (0x03)
------------	---------------	---------------	-----	-----	-------------------	----------	----------	------------

Table D- 48 Reply:

STX (0x02)	'3'	'9'	'9'	'4'	ETX (0x03)
------------	-----	-----	-----	-----	------------

The data field is 1 character representing which relay(s) to acknowledge. 'L' will acknowledge all relays. Note that if a relay is not in a mode that allows acknowledgement, it will not be acknowledged.

**Note**

Relay numbers start with zero, but in the meter instruction manuals, relay numbering starts with one.



**Code: 37 Description: Current and Voltage Decimal Points**

Table D- 49 Command: Read

SOH (0x01)	Meter Ad- dress	Meter Ad- dress	'3'	'7'	'9'	'6'	ETX (0x03)
------------	--------------------	--------------------	-----	-----	-----	-----	------------

Table D- 50 Command: Write

SOH (0x01)	Meter Address	Meter Address	'3'	'7'	Current decimal point	Voltage decimal point	Checksum	Checksum	ETX (0x03)
------------	---------------	---------------	-----	-----	-----------------------	-----------------------	----------	----------	------------

Table D- 51 Reply: Write and Read

STX (0x02)	'3'	'7'	Current	Voltage	Checksum	Checksum	ETX (0x03)
------------	-----	-----	---------	---------	----------	----------	------------

Read or write the current and voltage (respectively) decimal point selections. The data field consists of two numbers representing the decimal point position. The range of each number is 0 to 6. This is the same data as described in command 20.

Number	Decimal Point Position
'0'	dddddd.
'1'	dddd.d
'2'	ddd.dd
'3'	dd.d
'4'	d.dd
'5'	.ddd
'6'	dddddd (no decimal)

 **CAUTION**

Starting with SITRANS RD200 Version 3.000, if the presently selected input is either mA or V, writing a new decimal point using this command will immediately update the displayed decimal point also.

**Code: 40 Description: 4-20 mA Output - Data**

Table D- 52 Command: Read

SOH (0x01)	Meter Address	Meter Address	'4'	'0'	'9'	'C'	ETX (0x03)
------------	---------------	---------------	-----	-----	-----	-----	------------

Table D- 53 Command: Write

SOH (0x01)	Meter Ad- dress	Meter Ad- dress	'4'	'0'	'+'	'0'	'0'	X	X	X	X	Check- sum	Check- sum	ETX (0x03)
------------	--------------------	--------------------	-----	-----	-----	-----	-----	---	---	---	---	---------------	---------------	------------

Table D- 54 Reply: Write and Read

STX (0x02)	'4'	'0'	'+'	'0'	'0'	X	X	'.'	X	X	Check- sum	Check- sum	ETX (0x03)
------------	-----	-----	-----	-----	-----	---	---	-----	---	---	---------------	---------------	------------

The data field is 7 characters. The range is 0 to +2399. Note that these values actually represent 0.00 to +23.99 milliamps. Note that the write command does not include a decimal point.

The reply data format is eight characters consisting of '+' followed by a number string. The number string is always seven characters, consisting of either six digits and a decimal point, or six digits with a leading zero if no decimal point is selected.

**Note**

Although the data range is 0.00 to 23.99 mA, the actual minimum and maximum outputs available may be different from this range, depending on hardware tolerances. The hardware is designed for a nominal range of 1.00 to 23.00 mA.

**Note**

If the 4-20 mA source selection is not Serial Communication(mA), this command will have no effect on the 4-20 mA output. The reply will be -99.99 to indicate this improper operation. Refer to Command 41 (next) for Modes.

**Code: 41 Description: 4-20 mA Output - Mode**

Table D- 55 Command: Read

SOH (0x01)	Meter Address	Meter Address	'4'	'1'	'9'	'B'	ETX (0x03)
---------------	------------------	------------------	-----	-----	-----	-----	---------------

Table D- 56 Command: Write

SOH (0x01)	Meter Address	Meter Address	'4'	'1'	'0' '8'	'0' to '4'	Checksum	Checksum	ETX (0x03)
---------------	------------------	------------------	-----	-----	------------	------------------	----------	----------	---------------

Table D- 57 Rely: Write and Read

STX (0x02)	'4'	'1'	'0' '8'	'0' to '4'	Checksum	Checksum	ETX (0x03)
------------	-----	-----	------------	------------------	----------	----------	------------

The operating parameters consist of two digits, representing 4-20 mA Output Installed Status and data source:

First Digit	Second Digit
0 – No 4-20 mA Output	0 – Display Value
8 – 4-20 mA Output	1 – Max Display Value
	2 – Min Display Value
	3 – Serial Communication: Data in mA
	4 – Factory Use Only: Serial Comm: Data in counts

**Code 42: Description: 4-20 mA Output - Filter Value**

Table D- 58 Command: Read

SOH (0x01)	Meter Ad- dress	Meter Ad- dress	'4'	'2'	'9'	'A'	ETX (0x03)
------------	--------------------	--------------------	-----	-----	-----	-----	------------

Table D- 59 Command: Write

SOH (0x01)	Meter Ad- dress	Meter Ad- dress	'4'	'2'	'+'	'0'	'0'	'0'	'0'	X	X	Check- sum	Check- sum	ETX (0x03 )
------------	--------------------	--------------------	-----	-----	-----	-----	-----	-----	-----	---	---	---------------	---------------	-------------

Table D- 60 Reply: Write and Read

STX (0x02)	'4'	'2'	'+'	'0'	'0'	'0'	'0'	X	X	Check- sum	Check- sum	
------------	-----	-----	-----	-----	-----	-----	-----	---	---	---------------	---------------	--

The data field is 7 characters consisting of "+0000" followed by the value. Valid values are 00, and 02 to 19. Note that this filtering is in addition to the display filtering.

**Note**

Filter Value cannot be accessed through the front panel menu.

**Code: 43 Description: 4-20 mA Output - Limits**

**Command: Read**

SOH (0x01)	Meter Address	Meter Address	'4'	'3'	'0' to '4'	Checksum	Checksum	ETX (0x03)
------------	---------------	---------------	-----	-----	------------------	----------	----------	------------

**Command: Write**

SOH (0x01 )	Meter Ad- dress	Meter Address	'4'	'3'	'0' to '4'	'+'	'0'	'0'	X	X	X	X	Check- sum	Check- sum	ETX (0x03)
-------------	--------------------	---------------	-----	-----	------------------	-----	-----	-----	---	---	---	---	---------------	---------------	------------

**Reply: Write and Read**

STX (0x02)	'4'	'3'	'+'	'0'	'0'	X	X	'.'	X	X	Check- sum	Check- sum	ETX (0x03 )
---------------	-----	-----	-----	-----	-----	---	---	-----	---	---	---------------	---------------	-------------------

Read and write the value for 4-20 mA Output Limit parameters. The first argument specifies which limit is to be accessed. The data field following it is 7 characters. The range is 0 to +2399. Note that these values actually represent 0.00 to +23.99 milliamps. The decimal point in the write command is implied. The following table shows the arguments for the various limit parameters.

Argument	Limit Parameter
'0'	Sensor Break Value
'1'	Overrange Value
'2'	Underrange Value
'3'	Max Value Allowed
'4'	Min Value Allowed

**Note**

Only the Sensor Break Value can be accessed through the front panel menu.

**Code: 44 Description: 4-20 mA Output - Input and Output Points****Command: Read**

SOH (0x01)	Meter Address	Meter Address	'4'	'4'	'0' to '3'	Checksum	Checksum	ETX (0x03)
------------	---------------	---------------	-----	-----	------------------	----------	----------	------------

**Command: Write**

SOH (0x01 )	Meter Ad- dress	Meter Ad- dress	'4'	'4'	'0' to '3'	'+' '.'	'0'	'0'	X	X	X	X	Check sum	Check sum	ETX (0x03 )
-------------------	--------------------	--------------------	-----	-----	------------------	------------	-----	-----	---	---	---	---	--------------	--------------	-------------------

**Reply: Write and Read**

STX (0x02)	'4'	'4'	'+' '.'	'0'	'0'	X	X	X	X	X	Check-sum	Check-sum	ETX (0x03)
------------	-----	-----	------------	-----	-----	---	---	---	---	---	-----------	-----------	------------

Read and write the value for 4-20 mA Input and Output points. The first argument specifies which point is to be accessed. The data field following it is 7 characters.

Note that the values for DAC Outputs 1 and 2 actually represent 0.00 to +23.99 milliamps.

The range for Display Values is -1999 to +9999. The decimal point in the write command is implied. The decimal point in the reply for the Display Values will reflect the presently selected decimal point, but is fixed (00XX.XX) for the DAC Output values.

The following table shows the arguments for the various limit parameters.

Argument	Point	Range
'0'	Display Value 1	-1999 to +9999
'1'	Display Value 2	-1999 to +9999
'2'	DAC Output 1	00.00 to +23.99
'3'	DAC Output 2	00.00 to +23.99

**Code: 47 Description: Cutoff Value**

Table D- 61 Command: Read

SOH (0x01)	Meter Address	Meter Address	'4'	'7'	'9'	'5'	ETX (0x03)
------------	---------------	---------------	-----	-----	-----	-----	------------

Table D- 62 Command: Write

SOH (0x01)	Meter Address	Meter Address	'4'	'7'	'+' '.'	'0'	'0'	X	X	X	X	Check sum	Check sum	ETX (0x03)
------------	---------------	---------------	-----	-----	------------	-----	-----	---	---	---	---	-----------	-----------	------------

Table D- 63 Reply: Write and Read

STX (0x02)	'4'	'7'	'+' '.'	'0'	'0'	X	X	X	X	X	Check-sum	Check-sum	ETX (0x03)
------------	-----	-----	------------	-----	-----	---	---	---	---	---	-----------	-----------	------------

Read and write the value for the display Cutoff. Range is from 0000 to 9999, ignoring the decimal point. 0000 will disable cutoff. Cutoff is valid only for process inputs (current and voltage).

The reply data format is eight characters consisting of '+' followed by a number string. The number string is always seven characters, consisting of either six digits and a decimal point, or six digits with a leading zero if no decimal point is selected. Note that the write command does not include the decimal point regardless of the decimal point setting.

**Code: 48 Description: Linear/Exponential Selection**

Table D- 64 Command: Read

SOH (0x01)	Meter Address	Meter Address	'4'	'8'	'9'	'4'	ETX (0x03)
------------	---------------	---------------	-----	-----	-----	-----	------------

Table D- 65 Command: Write

SOH (0x01)	Meter Ad- dress	Meter Ad- dress	'4'	'8'	'L' 'E'	Checksum	Checksum	ETX (0x03)
------------	--------------------	--------------------	-----	-----	------------	----------	----------	------------

Table D- 66 Reply: Write and Read

STX (0x02)	'4'	'8'	'L' 'E'	Checksum	Checksum	ETX (0x03)
------------	-----	-----	------------	----------	----------	------------

Select Linear ('L') or Exponent ('E') display mode.

Linear:  $DisplayValue = (ADC\_count * Gain) + Offset$ ,

Exponent:  $DisplayValue = ((ADC\_count - Input\_low)0.5 * Gain) + Offset$ , where Input\_low, Gain, and Offset are user defined, either through scaling or external calibration.

# Modbus register tables

This section describes how to communicate with the SITRANS RD200 meter using the Modbus<sup>®</sup> RTU Serial Communication Protocol. The user should be familiar with Modbus serial communication and the meter. Refer to the instruction manuals for the meter and the serial communication adapters for setup and wiring instructions.

## E.1 Register Overview

40001 – 40016: Process Value (PV), Max PV, Min PV in integer and floating point formats, with interspersed relay status for block reading, Initialize, Reset Max & Min display value, Alarm & Relay status, Relay acknowledge, Linear/Square Root selection, Remote Process scaling initiation.

40101 – 40113: Input selection, Decimal points, Adjust, Bypass, Cutoff, Filter, Lock, Baud, Parity, Modbus Address, and Byte-to-byte timeout, Display Intensity.

40201 – 40212: Remote Scaling for Process inputs.

40301 – 40310: Relays; Set & Reset points, Turn-on & Turn-off delays, Operating Mode.

40401 – 40412: 4-20 mA output; Mode, Filter, Sensor Break value, Overrange value, Underrange value, Maximum allowed, Minimum allowed, Display 1 value, Display 2 value, Output 1, Output 2, Data (mA), Data (bits)



49101 – 49116: Product ID, Firmware Version, and Manufacturing Serial Number.

Register <sup>1</sup>		Name	Access	Limits or Range <sup>2</sup>	Units	Data Type <sup>3</sup>	Function Code(s)	Comments																																																
Number	Address (hex)																																																							
40001	0 (0000)	Display value	Read Only	-1999 to +9999	User Defined	Integer	03, 04	Represents the display value without the decimal point. Decimal point setting in 40102.																																																
40002	1 (0001)	Alarm and Relay status	Read both, Write Relays	1 = In Alarm  1 = relay energized	None	Bits	03, 06, 04	Read alarm status and energized/non-energized status of relays. Alarms are read only, so the upper byte is ignored for writes. Writing to a relay is only allowed when the relay is in the meter-disabled (Modbus accessible) mode. When writing, bits 2 through 15 are ignored. Alm = Alarm. Rly = Relay.  <table border="1" style="margin-left: auto; margin-right: auto;"> <tr> <td>15</td><td>14</td><td>13</td><td>12</td><td>11</td><td>10</td><td>9</td><td>8</td><td>7</td><td>6</td><td>5</td><td>4</td><td>3</td><td>2</td><td>1</td><td>0</td> </tr> <tr> <td>0</td><td>0</td><td>0</td><td>0</td><td>0</td><td>0</td><td>Alm</td><td>Alm</td><td>0</td><td>0</td><td>0</td><td>0</td><td>0</td><td>0</td><td>Rly</td><td>Rly</td> </tr> <tr> <td></td><td></td><td></td><td></td><td></td><td></td><td>2</td><td>1</td><td></td><td></td><td></td><td></td><td></td><td></td><td>2</td><td>1</td> </tr> </table>	15	14	13	12	11	10	9	8	7	6	5	4	3	2	1	0	0	0	0	0	0	0	Alm	Alm	0	0	0	0	0	0	Rly	Rly							2	1							2	1
15	14	13	12	11	10	9	8	7	6	5	4	3	2	1	0																																									
0	0	0	0	0	0	Alm	Alm	0	0	0	0	0	0	Rly	Rly																																									
						2	1							2	1																																									
40003	2 (0002)	Maximum Display value	Read Write	-1999 to +9999	User defined	Integer	03, 06, 04	Represents the Maximum display value, excluding the decimal point, since last power up or Max Value reset. Decimal point setting in 40102. Writing any value will reset the Maximum display value to the present display value.																																																
40004	3 (0003)	Minimum Display value	Read Write	-1999 to +9999	User defined	Integer	03, 06, 04	Represents the Minimum display value, excluding the decimal point, since last power up or Min Value reset. Decimal point setting in 40102. Writing any value will reset the Minimum display value to the present display value.																																																
40005 – 40006	4 – 5 (0004 – 0005)	Display value	Read Only	-1999 to +9999	User defined	Floating point	03, 04	Represents the display value including the decimal point. Accessing 40005 or 40006 by itself will return 0xFFFF.																																																
40007	6 (0006)	Alarm and Relay status	Read both, Write Relays	1 = In Alarm 1 = relay energized	None	Bits	03, 06, 04	Mirror of 40002.																																																

Register <sup>1</sup>		Name	Access	Limits or Range <sup>2</sup>	Units	Data Type <sup>3</sup>	Function Code(s)	Comments
Number	Address (hex)							
40008 – 40009	7 – 8 (0007 – 0008)	Maximum Display value	Read Only	-1999 to +9999	User defined	Floating point	03, 04	Represents the Maximum display value, including the decimal point, since last power up or Max Value reset. Accessing 40008 or 40009 by itself will return 0xFFFF.

## Modbus register tables

### E.1 Register Overview

40010 – 40011	9 – 10 (0009– 000A)	Mini- mum Display value	Read Only	-1999 to +9999	User de- fined	Floa- ting point	03, 04	Represents the Minimum display value, including the decimal point, since last power up or Min Value reset. Accessing 40010 or 40011 by itself will return 0xFFFF.																																
40012	11 (000B)	Line- ar/Square Root	Read Write	0xFF00 = Sq. rt 0x0000 = Linear	None	Bit	03, 06, 04	Determines process input function. Write 0x0000 for linear function. Write 0xFF00 for square root. Any other write value is ignored and has no effect.																																
40013	12 (000C)	Alarm Acknowl edge	Write Only	Not appli- cable	None		06	Clear Relay n alarm condition. Set bit equal to 1 to acknowledge. Only has effect on relays programmed to allow manual acknowledging. Alm = Alarm; X = don't care.																																
								<table border="1"> <tr> <td>15</td><td>14</td><td>13</td><td>12</td><td>11</td><td>10</td><td>9</td><td>8</td><td>7</td><td>6</td><td>5</td><td>4</td><td>3</td><td>2</td><td>1</td><td>0</td> </tr> <tr> <td>X</td><td>X</td><td>X</td><td>X</td><td>X</td><td>X</td><td>Al m 2</td><td>Al m 1</td><td>X</td><td>X</td><td>X</td><td>X</td><td>X</td><td>X</td><td>X</td><td>X</td> </tr> </table>	15	14	13	12	11	10	9	8	7	6	5	4	3	2	1	0	X	X	X	X	X	X	Al m 2	Al m 1	X	X	X	X	X	X	X	X
15	14	13	12	11	10	9	8	7	6	5	4	3	2	1	0																									
X	X	X	X	X	X	Al m 2	Al m 1	X	X	X	X	X	X	X	X																									
40014	13 (000D)	Initialize Meter	Write Only	0xFF00 to initialize.	None	Bit	06	Write 0xFF00 to reinitialize the meter. Writing any other data has no effect.																																
40015	14 (000E)	Remote Scale mA	Write Only	0xFF00 to execute remote scaling.		Bit	06	Used to remote scale the mA input. Writing any other data has no effect. Caution! See "Remote scaling procedure" in Register Notes below.																																
40016	15 (000F)	Remote Scale Volts	Write Only	0xFF00 to execute remote scaling.	None	Bit	06	Used to remote scale the Volts input. Writing any other data has no effect. Caution! See "Remote scaling procedure" in Register Notes below.																																
40101	100 (0064)	Input selection	Read Write	Not applicable	None		03, 06, 16, 04	See Register Notes (Page 96).																																

Register <sup>1</sup>		Name	Access	Limits or Range <sup>2</sup>	Units	Data Type <sup>3</sup>	Func- tion Code(s)	Comments
Num- ber	Address (hex)							
40102	101 (0065)	Active Decimal Point	Read Write	1, 2, 3, or 6	None	Integer	03, 06, 16, 04	6 = no decimal point. 1 to 3 = number of digits to right of dp. Mirror of bits 6-4 of 40101. Only process decimal points can be written. Writing a non-process dp returns 0xFFFF.
40103	102 (0066)	Current and Voltage decimal points	Read Write	0x00CV, where C & V = 1, 2, 3, or 6.	None	Word	03, 06, 16, 04	See "Decimal Point for RD200" on page 96. If an out of range value is sent for either or both decimal points, no change is made for that value. Valid settings are none, 1, 2, and 3 decimal places.

40104	103 (0067)	Adjust	Read Write	-199 to +199	°C or °F	Integer	03, 06, 16, 04	Actually represents -19.9 to +19.9. Offset value is only applied to temperature inputs. If Adjust is greater than 11°C and the temperature units are switched to °F, it will be set to 19.9 (lower than -11, set to -19.9).
40105	104 (0068)	Bypass	Read Write	2 to 999	Percent of full scale or °F	Integer	03, 06, 16, 04	Actually represents 0.2 to 99.9. If the input steps greater than the bypass value, it will be displayed immediately, with no filtering occurring. The number represents percent of full-scale for process inputs and °F for temperature inputs. No effect if filter = 0.
40106	105 (0069)	Cutoff	Read Write	0 to 9999	User Defined	Integer	03, 06, 16, 04	Represents the cutoff value without the decimal point. Valid only for process inputs.
40107	106 (006A)	Filter	Read Write	0, 2 to 199	Unit-less	Integer	03, 06, 16, 04	Display filtering. 0 = no filtering. New = old + ((new - old)/Filter)
40108	107 (006B)	Lock	Read Write	0x0000 to 0x9999	None	Integer (Packed BCD)	03, 06, 16, 04	See "The lock register" in Register Notes below.
40109	108 (006C)	Baud	Read Write	0 to 6	None	Integer	03, 06, 16, 04	0 = 300, 1 = 600, 2 = 1200, 3 = 2400, 4 = 4800, 5 = 9600, & 6 = 19200. Changes to this register are saved but don't take effect until next meter reset (Modbus command or power-up). Writing out of range data results in a baud rate of 2400.

Register <sup>1</sup>		Name	Access	Limits or Range <sup>2</sup>	Units	Data Type <sup>3</sup>	Function Code(s)	Comments
Number	Address (hex)							
40110	109 (006D)	Parity	Read Write	0 to 2	None	Word; bit flags	03, 06, 16, 04	0 = None, 1 = Odd, 2 = Even. Changes to this register are saved but don't take effect until next meter reset (Modbus command or power-up). Writing out of range data results in a parity setting of Even.

Modbus register tables

E.1 Register Overview

40111	110 (006E)	Byte-to-byte timeout	Read Write	0 to 2.54	Seconds	Integer	03, 06, 16, 04	This is the timeout between bytes of a Modbus frame. Note that a value less than the minimum value for the present baud rate cannot be saved. Minimums are: 300 baud = 0.06 secs, 600 = 0.03, 1200 = 0.02 and 0.01 for 2400 to 19200. Changes to this register are saved but don't take effect until next meter reset (Modbus command or power-up). Writing out of range data results in a timeout of 2.54 seconds.
40112	111 (006F)	Modbus Address	Read Write	1 to 247	None	Integer	03, 06, 16, 04	Changes to this register are saved but don't take effect until next meter reset (Modbus command or power-up). Writing out of range data results in an address of 247.
40113	112 (0070)	Display Intensity	Read Write	1 to 8	None	Integer	03, 06, 16, 04	8 is the brightest level. Writing out of range data results in level 2 brightness.
			Read Write					
40201 40202	200 (00C8) 201 (00C9)	Display 1 & 2, mA		-1999 to 9999	User Defined	Integer	03, 06, 16, 04	Used to remotely scale the mA input. This data represents the display value without a decimal point. Caution! See "Remote scaling procedure" in Register Notes below.
40203 – 40204 40205 – 40206	202 – 203 (00CA– 00CB)  204 – 205 (00CC– 00CD)	Input 1 & 2, mA	Read Write	-1999 to 2000	10's of A (-19.99 to 20.00 mA)	Floating point	03, 06, 16, 04	Used to remotely scale the mA input. If data sent is out of range, default values of 400 and 2000, respectively, will be used instead. This data represents the input points in mA. For example: 400 4.00 mA. Caution! See "Remote scaling procedure" in Register Notes below.

Register <sup>1</sup>		Name	Access	Limits or Range <sup>2</sup>	Units	Data T ype <sup>3</sup>	Function Code(s)	Comments
Number	Address (hex)							
40207 40208	206 (00CE) 207 (00CF)	Display 1 & 2, Volts	Read Write	-1999 to 9999	User Defined	Integer	03, 06, 16, 04	Used to remotely scale the Volts input. If data sent is out of range, de- fault values of 0 and 1000, respectively, will be used instead. This data represents the display value without a decimal point. Caution!  See "Remote scaling pro- cedure" in Register Notes below.
40209 – 40210 40211 – 40212	208 – 209 (00D0– 00D1) 210 – 211 (00D2– 00D3)	Input 1 & 2, Volts	Read Write	PD644: 0 to 3000  PD765: - 999 to 1000	PD644: Tenths of Volts (000.0 to 300.0 V)  PD765: 10's of mV (-9.99 to 10.00 V)	Floating point	03, 06, 16, 04	Used to remotely scale the Volts input. If data sent is out of range, de- fault values of 0 and 1000, respectively, will be used instead. This data represents the input points in volts. For exam- ple: 1000 10.00 V. Cau- tion!  See "Remote scaling pro- cedure" in Register Notes below.
40301 To 40305	300 301 302 303 304 (012C to 0130)	Relay 1: Set point Reset point Turn-on delay Turn-off delay Mode	Read Write	-1999 to +9999 - 1999 to +9999 0 to 199 0 to 199 Bits 4, 2, 1, 0	User Defined User Defined Seconds Seconds None	Integer Integer Integer Word: bits	03, 06, 16, 04	Set and Reset points rep- resent the display value without the decimal point.  See Relay Configuration (Page 99)
40306 To 40310	305 306 307 308 309 (0131 to 0135)	Relay 2: Set point Reset point Turn-on delay Turn-off delay Mode	Read Write	-1999 to +9999 - 1999 to +9999 0 to 199 0 to 199 Bits 4, 2, 1, 0	User Defined User Defined Seconds Seconds None	Integer Integer Integer Word: bits	03, 06, 16, 04	Set and Reset points rep- resent the display value without the decimal point.  See Relay Configuration (Page 99)

## E.1 Register Overview

Register <sup>1</sup>		Name	Access	Limits or Range <sup>2</sup>	Units	Data Type <sup>3</sup>	Function Code (s)	Comments
Number	Address (hex)							
40401	400 (0190)	4-20mA out – Mode	Read Write	0000 0000 y000 0yyy	None	Integer	03, 06, 16, 04	Selects output option and where the data source for the 4-20 mA output. See 4-20 mA Output Mode (Page 99)
40402	401 (0191)	4-20mA out – Filter	Read Write	0, 2 to 19	None	Integer	03, 06, 16, 04	This feature is not available through manual programming. 4-20 mA filtering: 0 = no filtering. Writing out of range data results in a value of 0. New = old + ((new - old)/Filter)
40403	402 (0192)	4-20mA out – Sensor Break value	Read Write	0 to 2399	10s of A	Integer	03, 06, 16, 04	Due to hardware variations, actual output range is designed to be at least 1.00 to 23.00 mA. Writing out of range data results in a value of 3.00 mA.
40404	403 (0193)	4-20mA out – Overrange value	Read Write	0 to 2399	10s of A	Integer	03, 06, 16, 04	This feature is not available through manual programming. Due to hardware variations, actual output range is designed to be at least 1.00 to 23.00 mA. Writing out of range data results in a value of 21.00 mA.
40405	404 (0194)	4-20mA out – Underrange value	Read Write	0 to 2399	10s of A	Integer	03, 06, 16, 04	This feature is not available through manual programming. Due to hardware variations, actual output range is designed to be at least 1.00 to 23.00 mA. Writing out of range data results in a value of 3.00 mA.
40406	405 (0195)	4-20mA out – Maximum value allowed	Read Write	0 to 2399	10s of A	Integer	03, 06, 16, 04	This feature is not available through manual programming. Due to hardware variations, actual output range is designed to be at least 1.00 to 23.00 mA. Writing out of range data results in a value of 23.00 mA
40407	406 (0196)	4-20mA out – Minimum value allowed	Read Write	0 to 2399	10s of A	Integer	03, 06, 16, 04	This feature is not available through manual programming. Due to hardware variations, actual output range is designed to be at least 1.00 to 23.00 mA. Writing out of range data results in a value of 0.00 mA.
40408	407 (0197)	4-20mA out – Display Value 1	Read Write	-1999 to +9999	User Defined	Integer	03, 06, 16, 04	4-20mA out scaling. Represents the display value without the decimal point.

Register <sup>1</sup>		Name	Access	Limits or Range <sup>2</sup>	Units	Data Type <sup>3</sup>	Function Code(s)	Comments
Number	Address (hex)							
40409	408 (0198)	4-20mA out – Display Value 2	Read Write	-1999 to +9999	User Defined	Integer	03, 16, 04	4-20mA out scaling. Represents the display value without the decimal point.
40410	409 (0199)	4-20mA out – Output 1	Read Write	0 to 2399	10s of A	Integer	03, 06, 16, 04	4-20mA out scaling. Represents the mA output at Display 1 value without decimal point. Writing out of range data results in a value of 23.99 mA.
40411	410 (019A)	4-20mA out – Output 2	Read Write	0 to 2399	10s of A	Integer	03, 06, 16, 04	4-20mA out scaling. Represents the mA output at Display 2 value without decimal point. Writing out of range data results in a value of 23.99 mA.
40412	411 (019B)	4-20mA out – Data in mA or Data in bits	Read Write	0 to 2399 or 0 to 65535	10s of A (00.00 to 23.99 mA) or DAC bits	Integer	03, 06, 16, 04	If 4-20mA out mode is set to "Serial Comm., mA" (0x83) this register is in 10's of A. Due to hardware variations, the actual output range is at least 1.00 to 23.00 mA. Writing out of range data results in a value of 23.99 mA. If 4-20mA out mode is set to "Serial Comm., bits" (0x84), this register is in DAC bits. See "4-20 mA Output Modes" on page 97.
49101 to 49104	9100 – 9103 (238C – 238F)	Product Identifier	Read Only	Not applicable	None	ASCII characters	03, 04	8 characters indicating the product firmware number
49105 to 49108	9104 – 9107 (2390 – 2393)	Firmware Version	Read Only	Not applicable	None	ASCII characters	03, 04	8 characters indicating the product firmware number
49109 to 49116	9108 – 9115 (2394 – 239B)	Mfg. Serial Number	Read Only	Not applicable	None	ASCII characters	03, 04	16 (max) characters indicating the manufacturing serial number information.

## E.2 Register Notes

### Notes:

#### 1. Register numbers and Addresses

The Register numbers and addresses follow the Modbus format:

- 3xxxx are for Input Registers and are read-only.
- 4xxxx are for Holding Registers and are read/write.

Although there are no specific 3x Registers, all 4x Registers are mirrored into 3x register space, and are therefore capable of being read by Modbus function 04 (Read Input Registers). All data addresses in Modbus messages are referenced to zero (0), while Register addresses are referenced to one (1). For example, Register 40100 is sent in the Modbus message as 0x0063 (100-1 = 99 63 hex). If two addresses are shown separated by a " – ", they form a register pair to make the parameter into a 4-byte (32 bit) value.

#### 2. Limits or Range

Writing a value that is outside the parameters range will force it to be limited to the closest value within the range. For example, if the range is -1.99 to +1.99 and the value sent is 3.21, the value used is 1.99. Likewise for the lower side of the range. Exceptions are noted in the comments.

#### 3. Data Types

Data format is highest byte first.

Word = 16 bit

Integer = -32768 to 32767

Long = -2,147,483,648 to 2,147,483,647

Float = IEEE floating point format, 4 bytes

"Decimal point setting in 40102." These values represent the number without regard to the decimal point. The decimal point setting can be found in Holding Register 40102. For example, if the number 12.34 is displayed, a read of 40001 will return 1234 (0x04D2). Register 40102 will contain 2 (0x0002) to indicate a decimal point setting of two places to the right of the decimal point. Floating point versions of these numbers, with the decimal point included, are also available.



**Examples (register values are shown in hexadecimal):**

Process value displayed	Register 40001	Register 40102	Registers 40005 – 40006
1.234	04D2	0003	3F9D – F3B6
12.34	04D2	0002	4145 – 70A4
123.4	04D2	0001	42F6 – CCCD
-123.4	FB2E	0001	C2F6 – CCCD

## 4. Remote scaling procedure

- a. Write the desired values for the display, Display 1 & 2.
- b. Write the desired values for the input, Input 1 & 2, for mA or volts. Note that the values written to SITRANS RD200 are (mA \* 100) or (volts \* 100) because of the meter's input specifications (4 digit, 20.00 mA and 10.00 volt input ranges).
- c. Write to the remote scaling register for either mA or volts.

 **WARNING**

The scaling process takes the input values in mA or volts and converts them to A/D counts. Therefore, do NOT execute a remote scaling register write without first writing the display and input registers. Similarly, do NOT write to the mA (volts) registers and then execute a remove scale command for the volts (mA) input.

## 5. The Lock Register

A read of the Lock register will return 0x0000 if the meter is unlocked, otherwise it will return 0xFFFF to indicate a locked meter. To unlock, the correct lock number must be written, which will then clear the lock number to 0x0000. If the wrong lock number is written, the reply will return 0xFFFF. If the correct lock number is written, the reply will be 0x0000. An unlocked meter can be locked by writing any non-zero value, but the value must be in BCD (i.e. only nybbles between 0 and 9. If a nybble between A and F is sent, no change to lock status will occur and the return value will be 0xFF00).

## 6. Modbus® is a Registered Trademark of Schneider Automation Inc.

E.3 Decimal Point

Temperature sensor type and units are only used when temperature is input selected. Decimal point is automatically set for SITRANS RD200, if temperature input is selected. Invalid selections will result in default settings (shown by the asterisks). Defaults are based on the input selected: for example, if RTD is selected, thermocouple type selection is not allowed and decimal point is forced to none.

Bit(s)	15	14, 13, 12		11, 10, 9, 8		7, 6, 5, 4, 3, 2, 1, 0		
Function	°F or °C	Active decimal point setting		Temperature sensor type		Input selected		
	0	°C	0x1000	123.4	0x0000	J *	0x0000	Volts *
	1	°F	0x2000	12.34 *	0x0100	K	0x0011	mA
			0x3000	1.234	0x0200	T	0x0022	RTD
			0x6000	1234	0x0300	T, 0.1°	0x0023	TC
					0x0400	E		
					0x0500	100 RTD *		
					0x0600	100 RTD		
					0.00385			
					0.00392			

\* Default settings for invalid selections

### E.3 Decimal Point

Bit(s)	15 - 8	7 - 4	3 - 0
Function	00000000	Decimal Point for mA	Decimal Point for Volts
		<b>Decimal Point Selections for RD200</b>	
		0x1	123.4
		0x2	12.34
		0x3	1.234
		0x6	1234

The relationship between these decimal point settings and the one found in 40101 (and mirrored in 40102) is that the decimal point setting in 40101 is the active (presently displayed) decimal point, and the settings found in 40103 are the settings for the mA and Volts inputs. If the mA input is selected, the decimal point setting in bits 14 to 12 of 40101 will be the same as the one in bits 7 to 4 of 40103. If the voltage input is selected, the decimal point setting in bits 14 to 12 of 40101 will be the same as the one in bits 3 to 0 of 40103. If a temperature input is selected, the settings in 40103 may or may not be the same as the active setting (in 40101). There is no storage for the decimal point settings for the RTD or thermocouple inputs because these are fixed.

## E.4 Relay Configuration

Bit(s)	15 – 8	7 – 5	4	3	2 – 0	
Function	00000000	000	Normal/ Fail-Safe	0	Operation	
			0	Normal	0	Automatic reset
			1	Fail-Safe	1	Auto & Manual reset
					2	Latching
					3	Latching with Clear
					4	Pump Alternation
					5	Unused
					6	Unused
					7	Off (Disabled) (Modbus accessible)

## E.5 4-20 mA Output Mode

Bit(s)	15 – 8	7	6 – 3	2 – 0		
Function	00000000	Output Option	000 0	4-20 mA Data Source		
		0	Relays	4	Serial Comm., bits	The data for the 4-20 mA output is register 40412.
		1	4-20 mA	5	Unused	
				6	Unused	
				7	Unused	

## E.6 Available Register Table

This table shows available registers for SITRANS RD200 with firmware version 3.xxx.

RD200 Version 3. xxx	
• 40001 to 40016	• 40301 to 40310
• 40101 to 40113	• 40401 to 40412
• 40201 to 40212	• 49101 to 49116

# Product documentation and Support

## F.1 Product documentation

Process instrumentation product documentation is available in the following formats:

- Certificates (<http://www.siemens.com/processinstrumentation/certificates>)
- Downloads (firmware, EDDs, software) (<http://www.siemens.com/processinstrumentation/downloads>)
- Catalog and catalog sheets (<http://www.siemens.com/processinstrumentation/catalogs>)
- Manuals (<http://www.siemens.com/processinstrumentation/documentation>)

You have the option to show, open, save, or configure the manual.

- "Display": Open the manual in HTML5 format
- "Configure": Register and configure the documentation specific to your plant
- "Download": Open or save the manual in PDF format
- "Download as html5, only PC": Open or save the manual in the HTML5 view on your PC

You can also find manuals with the Mobile app at Industry Online Support (<https://support.industry.siemens.com/cs/ww/en/sc/2067>). Download the app to your mobile device and scan the device QR code.

### Product documentation by serial number

Using the PIA Life Cycle Portal, you can access the serial number-specific product information including technical specifications, spare parts, calibration data, or factory certificates.

#### Entering a serial number

1. Open the PIA Life Cycle Portal (<https://www.pia-portal.automation.siemens.com>).
2. Select the desired language.
3. Enter the serial number of your device. The product documentation relevant for your device is displayed and can be downloaded.

To display factory certificates, if available, log in to the PIA Life Cycle Portal using your login or register.

#### Scanning a QR code

1. Scan the QR code on your device with a mobile device.
2. Click "PIA Portal".

To display factory certificates, if available, log in to the PIA Life Cycle Portal using your login or register.

## F.2 Technical support

### Technical support

If this documentation does not completely answer your technical questions, you can enter a Support Request (<http://www.siemens.com/automation/support-request>).

For help creating a support request, view this video here ([www.siemens.com/opensr](http://www.siemens.com/opensr)).

Additional information on our technical support can be found at Technical Support (<http://www.siemens.com/automation/csi/service>).

### Service & support on the Internet

In addition to our technical support, Siemens offers comprehensive online services at Service & Support (<http://www.siemens.com/automation/serviceandsupport>).

### Contact

If you have further questions about the device, contact your local Siemens representative at Personal Contact (<http://www.automation.siemens.com/partner>).

To find the contact for your product, go to "all products and branches" and select "Products & Services > Industrial automation > Process instrumentation".

Contact address for business unit:

Siemens AG  
Digital Industries  
Process Automation  
Östliche Rheinbrückenstr. 50  
76187 Karlsruhe, Germany

# Index

## C

Catalog  
    catalog sheets, 100  
Certificates, 100  
Customer Support, (Refer to Technical support)

## D

Downloads, 100

## H

Hotline, (Refer to Support request)

## M

Manuals, 100

## S

Service, 101  
Service and support  
    Internet, 101  
Support, 101  
Support request, 101

## T

Technical support, 101  
    partner, 101  
    personal contact, 101