

# Manual deltawaveC-F/P

Ultrasonic flow and heat measurement  
portable



Stationary



Ver. 3.0.0 and higher

# Table of content

Table of content .....	2
1 Preamble .....	5
2 About this manual .....	6
3 deltaxwaveC-F/P & components .....	7
3.1 Approvals / EMC .....	7
3.2 Scope of delivery deltaxwaveC-F / P basic package .....	8
3.3 Transducer .....	9
3.4 Safety instructions .....	10
3.5 Important instructions for the use of deltaxwaveC-P .....	10
4 Measuring principle .....	11
4.1 2-channel device applications .....	13
5 deltaxwaveC-F/P Interfaces .....	14
5.1 Overview deltaxwaveC-P .....	14
5.2 Overview deltaxwaveC-F .....	15
5.3 Connection notes .....	16
6 Operating .....	17
6.1 Control Buttons .....	17
6.2 How to navigate .....	17
6.3 Select measurement channel .....	17
7 First Start .....	18
7.1.1 Adjustment of the display language .....	18
7.1.2 Navigation in main menu .....	18
7.1.3 Setting time and date .....	19
8 Preparing for measurement deltaxwaveC-F/P .....	20
8.1 Preparation of the measurement / installation location .....	21
.....	21
8.1.1 Inlet and outlet distances .....	21
8.1.2 Basic principles for ultrasonic transducer assembly .....	22
8.1.3 Ultrasonic sensor Mounting on horizontal pipelines .....	23
8.1.4 Ultrasonic transducer on uneven surfaces .....	24
8.2 Fundamentals of parameterization .....	24
8.3 Parameterization with the Quick Setup .....	26
8.4 Sensor assembly / Sensor distance .....	28
8.4.1 Structure of ultrasonic transducers .....	28
8.4.2 Mounting ultrasonic transducer .....	29
8.4.3 Selection of transducer types .....	30
8.4.4 Selection of mounting options .....	30
8.4.5 Selection mounting rail .....	31
8.4.6 Selection coupling media .....	32
8.4.7 Transducer mounting .....	33
8.4.8 Mounting of the Transducer in V-Mode or W-Mode .....	33
8.4.8.1 Mounting permanently installed .....	35

8.4.8.2	Mounting portable.....	36
8.4.9	Mounting the ultrasonic transducers based on the Z method .....	38
8.4.10	Mounting transducer with two mounting rails .....	40
8.4.10.1	Mounting Z-mode with two rails .....	40
8.4.10.2	Mounting at large distances.....	41
8.4.11	Mounting the ultrasonic transducers at two crossed measuring paths 42	
8.5	Alternative sensor distance.....	42
8.6	Zero Setting .....	43
8.7	Signal optimisation.....	45
8.7.1	Open signal optimisation.....	45
8.7.2	Functionality Signal Optimisation .....	45
8.7.3	Gain-Optimization .....	46
8.7.4	Zero-Optimization .....	46
9	Heat measurement .....	47
9.1	Introduction.....	47
9.2	Installing the Pt100 .....	48
9.3	Parameterization of the Pt100 for the heat quantity measurement .....	49
10	Measuring windows deltaxwaveC-F/P.....	50
10.1	Headline .....	50
10.2	Measuring window "Flow 1" .....	51
10.3	Measuring window "Flow 2" .....	52
10.4	The measuring window "heat quantity" .....	53
10.5	Password protection .....	54
10.6	The measurement windows of the 2-channel deltaxwaveC-F .....	55
11	The main menu (complete menu).....	56
11.1	Loading, saving and managing parameter data .....	56
11.2	The pipe parameters.....	58
11.3	The Fluid Setup .....	59
11.4	The Transducer Setup .....	60
11.5	Parameterization of the inputs and outputs .....	61
11.5.1	Parameterization of the 4-20mA outputs.....	61
11.5.2	Parameterization of the relay .....	64
11.5.3	Parameterization of the pulse output .....	65
11.5.4	Pulse-Overflow-Error; IOE .....	66
11.6	Serial communication, Modbus, MBUS & Logger .....	66
11.6.1	Serial data transmission.....	66
11.6.2	Modbus .....	68
11.6.3	MBus.....	69
11.6.4	The Data Logger.....	70
11.6.4.1	Activation of the data logger: .....	70
11.6.4.2	Administration and structure of log data .....	71
11.6.4.3	Starting a time-controlled data record.....	72
11.6.4.4	Cancelling a time-controlled data record .....	73
11.6.4.5	Quick-Logger.....	74
11.6.4.6	WakeUp-Logger .....	74

11.6.4.7	Energy saving mode.....	75
11.7	Systems Settings.....	75
11.7.1	Editing the time and date.....	76
11.7.2	Changing the indicator light.....	76
11.7.3	Changing the menu language.....	77
11.7.4	System test.....	77
11.7.5	System information.....	78
11.7.6	System Reset.....	78
11.8	Unit selection.....	79
11.9	Calibration.....	80
11.9.1	Flow-Offset.....	80
11.9.2	Matching the Pt100.....	80
11.9.3	Pt100 Offset.....	80
11.9.4	Parameterization of a flow velocity characteristic.....	81
11.9.5	Temperature compensation.....	81
11.9.6	Calibration of analogue outputs.....	82
11.10	Miscellaneous Parameters.....	83
11.10.1	Damping & Burnout.....	83
11.10.2	Cut off Flow.....	84
11.10.3	Zero.....	84
11.10.4	The totalizer (counters).....	85
11.10.5	Pipe roughness.....	86
11.10.6	Sensor test.....	86
12	Additional information about the hardware.....	88
12.1	Hardware and Software Reset.....	88
12.2	Data export and import.....	89
13	Pulse outputs active/passive.....	90
13.1	RS232 / RS485 Interfaces.....	91
14	Tips and Tricks.....	92
14.1	Measuring mixed fluids.....	92
14.2	Measuring unknown fluids.....	94
15	Troubleshooting.....	96
15.1	The Oscilloscope Window.....	97
15.2	Signal analysis.....	98
15.2.1	Signal-to-noise ratio (SNR).....	99
15.2.2	Signal sharpness.....	101
15.2.3	Signal decoupling on small pipelines.....	102
15.2.4	The Auto window function / AFC-Technology.....	103
15.3	The diagnosis window of the deltaxwaveC-F/P.....	105
15.4	What to do if the pipe is not fully filled?.....	106
	Appendix A – Material data.....	107
	Appendix B – Technical data.....	110
	Appendix C – Modbus register overview.....	112
	Appendix D – Transducer type overview.....	114
	Appendix E – Mounting equipment and accessories.....	116

# 1 Preamble

Welcome to the team of deltaxaveC-F/P users and many thanks for using an ultrasonic clamp-on flowmeter from systemec Controls GmbH Germany.

deltawaveC-F/P was developed based on the KISS principle – “keep it safe and simple”.

That means maximum user friendliness paired with optimal and accurate measurements.

Our aim is to fulfil these aspirations both now and in the future. Our strength lies in continually improving and optimising our products and we want you to be part of this.

deltawaveC-F/P is an important product for us and not just one product on a long list of others.

Thanks to your competent and constructive suggestions you have helped to co-create deltaxaveC and contribute to its success.

Please don't hesitate to share your expert knowledge about deltaxaveC-F/P with us.

**We wish you all the best and great success with using deltaxaveC-F/P!**



## 2 About this manual

You don't have much time for reading? Use the beacon!

**Next to the chapters you will find red, orange or green dots. They will help you to find a quick introduction to the deltaxwaveC-F/P**

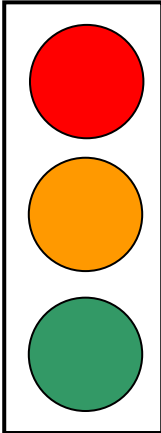

### Newcomer?

You have never worked with an ultrasonic meter before?  
Start at the first chapter. You will receive a step-by-step introduction to ultrasonic measuring technology.

### Advanced?

You have occasionally used ultrasonic measuring equipment?  
→ Start with chapter 10.1.3 "Quick setup"  
Start with the chapters that are marked with an orange spot. You may also want to continue reading the chapters with the green spot.

### Professional?

You already have professional knowledge of ultrasonic measuring systems?  
→ Start with the deltaxwaveC-F Getting Started (separate attachment)  
→ You may also want to read the green dot chapters



The fields identified with an exclamation mark contain important information that relates to the basic data and operation of the device.



The fields identified with the "i" contain supplementary and helpful information.

**The instruction manual describes the function of both deltaxwaveC-P and deltaxwaveC-F in 1-channel and 2-channel version. In addition to the chapters you will find the corresponding pictograms. This indicates which of the devices the chapter applies to.**



**deltaxwaveC-P**  
portable deltaxwaveC (1 Channel)



**deltaxwaveC-F**  
stationary deltaxwaveC  
1CH = 1 Channel; 2CH = 2 Channel



### 3 deltawaveC-F/P & components

#### deltawaveC-F/P key points:

- deltawaveC-F/P is a clamp-on ultrasonic flow meter for liquids in completely filled pipelines.
- deltawaveC-F/P works based on the transit time method.
- deltawaveC-F/P provides heat measurement by default. Clamp-on Pt100 temperature sensors are available as an optional.
- The power is supplied via integrated AC-power supply. For deltawaveC-F DC-power supply is available.
- The device supports measurements on pipelines with diameters in the range DN10 to DN6000 (depending on the sensor used)
- Temperature range (fluid):  $-40^{\circ}\text{C}$  to  $+150^{\circ}\text{C}$  (equates the temperature range of the clamp-on ultrasound transducers)
- deltawaveC-F/P is equipped with an electrically isolated output (relay), as well as 4 to 20 mA current (active and passive) and pulse outputs that can be operated in active and passive mode (with deltawaveC-F universally parameterisable).
- The stationary deltawaveC-F can optionally be equipped with an RS232 or RS485 interface card as well as with two additional analogue inputs.

#### 3.1 Approvals / EMC



deltawaveC-F/P is compliant with the following European Directives and Standards:

2014/35/EU Low voltage directive

2014/30/EU Electromagnetic compatibility

#### Inspection specifications:

- EN 55011 (2011-04)
- EN 61000-4-2 (2009-12)
- EN 61000-4-3 (2011-04)
- EN 61000-4-4 (2013-04)
- EN 61000-4-5 (2015-03)
- EN 61000-4-6 (2014-08)
- EN 61000-4-8 (2010-11)
- EN 61000-4-11 (2005-02)

#### Inspection requests:

- EN 61000-6-1 (2016-05)
- EN 61000-6-3 (2011-09)

### 3.2 Scope of delivery deltaxwaveC-F / P basic package

#### deltawaveC-F



#### deltawaveC-F & ultrasonic transducers

- deltaxwaveC-F flow transmitter
- Ultrasonic transducers incl. signal cables (cable length according to order)
- Spacer bar for transducers, except for FW05
- Mounting belt – stainless steel
- Quick start Guide
- USB stick with manual
- Acoustic coupling pads

#### deltawaveC-P



#### deltawaveC-P hard-shell case

- Hard-shell case
- deltaxwaveC-P flow transmitter
- Plug-in power adapter, including an IEC appliance power cable
- RG 58 connector cable for transducer
- Ultrasonic transducer (as ordered by the customer)
- Mounting material and spacer bar for transducers
- Cable for 4mA to 20mA analogue output (Mini DIN, alligator clips)
- Quick start Guide
- USB stick with Manual
- Ultrasonic coupling grease



Other ultrasonic transducers for smaller or larger pipe dimensions, as well as clamp-on temperature sensors, are available on separate order. Every deltaxwaveC-F can be retrofitted with a serial interface board (optional). It can be connected either to an RS232 serial interface board or to a RS485 interface.

You can reach your personal contact partner on the Internet at [www.systemec-controls.de](http://www.systemec-controls.de), or at the phone number +49 (0)89 80 90 60.

An overview of accessories and available transducer can be found in the appendix.



### 3.3 Transducer

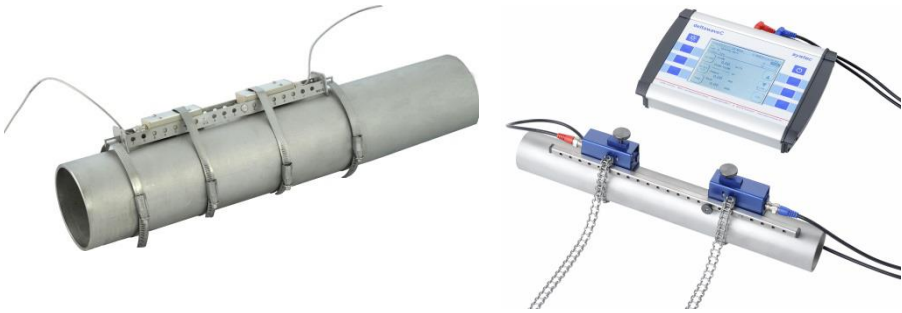

**Figure 1: deltaxwaveC-F/P – measuring converter and mounted ultrasound transducer; left: deltaxwaveC-F, right: deltaxwaveC-P**

Your deltaxwaveC-F / P essentially consist of the ultrasonic transducers mounted on your pipeline and the transmitter. The transmitter performs the signal processing and provides the user with the measurement results. The ultrasonic transducers transform the electrical energy into kinetic energy (acoustic wave). The ultrasonic transducer can also receive acoustic waves and convert these into electrical energy. An overview of the available converters can be found in the appendix.

The ultrasonic transducers will be mounted on the pipeline, they generate and receive the ultrasonic signals, by means of which flow rate will be calculated in the transmitter.



As a result of the measuring principle, each transmitter is equipped with a pair of ultrasonic transducers (A & B). Make sure ultrasonic transducers are aligned with the direction of flow. Pay attention with the deltaxwaveC-F (screw terminals), the loop has to be at the correct position and correct polarity:

- ( + ) = red cable (core)
- ( - ) = black cable (shield)



#### **UP-Transducer** (upstream positioned transducer):

The ultrasound transducer, which the flow passes first, is connected at the UP-contacts.

#### **DOWN-Transducer** (downstream positioned transducer):

The ultrasound transducer, which the flow passes second, is connected at the DOWN-contacts.

### 3.4 Safety instructions



- The operating temperature of the transmitter from -20°C to 60°C must not be exceeded!
- The ultrasonic sensors are sensitive to strong mechanical impacts (irreparable damage possible)!
- The transmitter and ultrasound transducers are generally not approved for operation in potentially explosive atmospheres (request documents for ATEX equipment).
- The ultrasonic sensors must not exceed the specified operating temperatures.
- Protect the transmitter from impacts.
- Avoid cable kinks on the sensor cables.
- Make sure that the power supply is suitable.
- The power supply unit of the deltawaveC-P is not protected against moisture. Use it only in dry rooms.
- Before connecting the deltawaveC-F to your power supply, make sure that it is deactivated (e.g. fuse off).

### 3.5 Important instructions for the use of deltawaveC-P



The plug-in power supply is only suitable for indoor use! In the case of mechanical or electrical damage to the plug-in power supply unit or the 230V power supply cable, these must be completely replaced!

DeltawaveC-P is equipped with a lithium-ion battery (Li-Ion 6000 mAh). This battery power is sufficient for approximately 22 hours of network-independent operation.

- ➔ If the deltawaveC-P is not used for a long time, recharge the battery at least once every 3 ... 6 months.
- ➔ The deltawaveC-P is equipped with a deep discharge protection. A pop-up message informs you before the device switches off automatically.
- ➔ To avoid unnecessary stress to the battery avoid connecting the deltawaveC-P to a power supply if it is already charged completely. A permanent connection to the power supply unit in the case of long-term measurements is possible, however.



DeltawaveC-P is equipped with a quick-charge function. The function is automatically activated after the deltawaveC-P is connected to the power supply unit until a charge level of 80 % is reached. This means that the unit can be operated again without connection to the power supply within a very short time.

**General information about the charge states:**

- Charging
- 50-100%
- 25-49%
- 10-25%
- <10%



The exclamation point in the battery indicator appears if the charge is too low, or if deltaxwaveC-P is busy determining the current charge status. Determining the charge level might take up to one minute. If the exclamation mark persists, the battery actually has a capacity <10%.



If "x" appears in the battery symbol, this means that the battery is defective or there is a fault in the charging circuit. If the symbol is also displayed after a restart of the deltaxwaveC-P, please contact systemec Controls.

## 4 Measuring principle

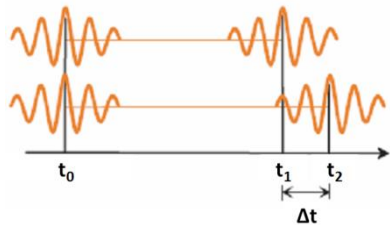
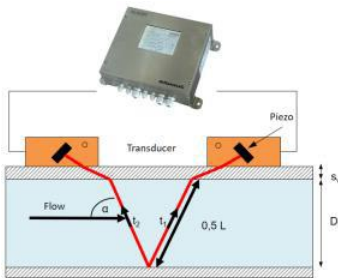

**Measuring principle:** Ultrasonic transit time difference method (Clamp-On)

For this purpose, two ultrasonic transducers are mounted on the pipeline from outside and connected to the evaluation electronics.

The ultrasonic transducers work alternately as transmitters and receivers and send ultrasonic signals at each other. These signals are accelerated or decelerated by the medium flow. The resulting difference in the two signal propagation times is proportional to the flow rate and is used together with the pipeline geometry for the precise calculation of the flow rate.

**Signal evaluation by means of cross-correlation:**

The signal processing operates based on a cross-correlation-based method, which enables signal detection even at a low signal-to-noise ratio. Based on the high-

quality signal evaluation, measurements with gas input or solid load of the medium are also possible within certain limits.

Calculation of the flow velocity [m/s]:

$$\bar{v} = L \frac{(\Delta t)}{t_2 \cdot t_1 \cdot 2 \cos \alpha} \cdot k_{Re}$$

Calculation of the volume flow:

$$Q = L \frac{(\Delta t)}{t_2 \cdot t_1 \cdot 2 \cos \alpha} \cdot k_{Re} \cdot \frac{D^2}{4} \cdot \pi$$

### Integrated Reynolds-compensation ( $k_{Re}$ ):

The transit time difference method provides to determine the mean flow velocity along the measuring path. The mean flow velocity over the tube cross-section can be determined by means of a compensation factor which is dependent on the Reynolds number.

The Reynolds number is determined iteratively from the current flow rate, the pipe diameter and the kinematic viscosity of the fluid. For fluids of the device-internal material database the data is provided.

The configuration of a user-defined medium is possible. For this purpose, the sound velocity (can be practically determined by iterative approximation, see 14.2) and the kinematic viscosity of the medium must be parameterized. The input of density and heat capacity is additionally required for determining the heat quantity.

$$Re = \frac{\rho \cdot \bar{v} \cdot D}{\mu} = \frac{\bar{v} \cdot D}{\nu}$$

Re... Reynolds number,  
v... flow velocity,  
D... diameter,  
 $\rho$ ... density,  
 $\mu$ ... dynamic viscosity,  
 $\nu$ ... kinematic viscosity,

### Integrated temperature compensation / Automatic Fluid Control (AFC):

Changes to the sound velocity of the liquid (temperature-dependent or when the medium changes) cause changes of signal path angles and path length. These deviations from the ideal path and the resulting measurement uncertainties are compensated automatically by a correction factor (qp factor) determined by deltaxwaveC-F / P without mechanical displacement of the transducers.

### Standard:

The basis for the calculation is the VDI/VDE directive 2642: "ULTRASONIC FLOW-RATE MEASUREMENT OF FLUIDS IN PIPES UNDER CAPACITY FLOW CONDITIONS" (12/1996)

## 4.1 2-channel device applications



The deltaxwaveC-F 2-channel transmitter enables the realization of exceptional measurement requirements for special applications. These are briefly described below.

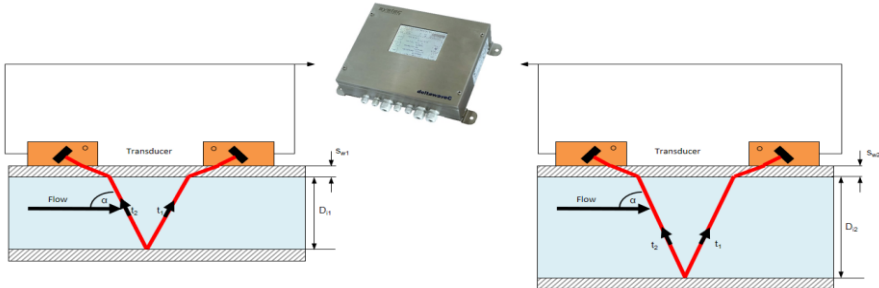

Two measuring paths can be operated separately at two different measuring points. In addition to the separate results of measuring points (CH1 or CH2), the sum, the difference as well as the mean value of both measuring paths are provided additionally (CH1 + CH2, CH1 - CH2, (CH1 + CH2) / 2).

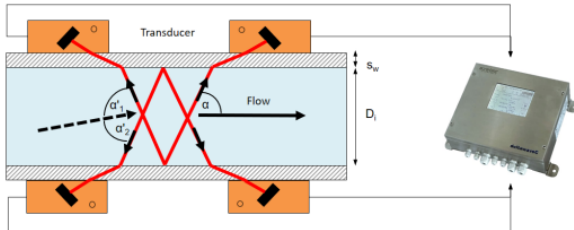

The mean value calculation is intended in particular for the use of both measuring paths at one measuring point. This utilization makes it possible to increase the accuracy and to reduce the effects of cross currents.

 The heat quantity determination is limited to the use of two measuring paths at one measuring point (only one pair of Pt100 can be connected). The calculation is performed only for (CH1 + CH2) / 2. A separate calculation only for CH1 and/or CH2 is not provided.

## 5 deltaxwaveC-F/P Interfaces



### 5.1 Overview deltaxwaveC-P

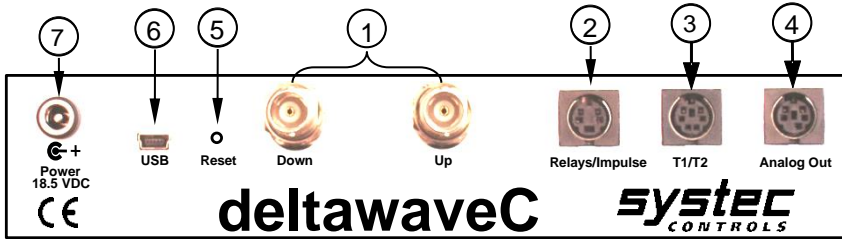

Term		Description
1	UP/ DWN	BNC-Inputs for ultrasonic transducer
2	Relays/ Pulse	Mini-DIN-4 connectors output: Relay connection (passive, potential-free); Digital output (open collector: 20, 40, 60, 100, 260, 500 ms square pulses)
3	T1/T2	Mini-DIN-6 connectors: 1 pair 3-conductor Pt100 (heat measurement):
4	Analog Out	2 Analogue outputs: 4...20mA signal, 24VDC, active (optional passive) from CTRL 2.1 according to Namur NE43 (3.8-20.5 mA)
5	RESET	Hardware-Reset (Restart of the system)
6	USB	USB Interface (Mini-USB Type B), access to the integrated SD memory card (Windows: Automatic detection as mass storage medium)
7	Power	Plug-in power: 19 V/DC, 3,42 A

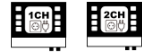

## 5.2 Overview deltaxwaveC-F

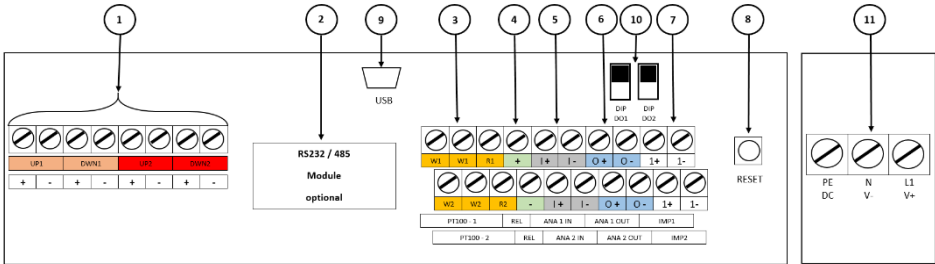

Term	Connection	Description
1	UP1	input for ultrasonic transducer measurement path 1 <b>( + ) = red cable (core); ( - ) = black cable (shield)</b>
	DWN1	
	UP2	
	DWN2	
<b>Only 2-channel transmitter</b>		
2	RS232 / RS485	optional + retrofitted (Digital Interface board) Data transmission via serial communication or Modbus and MBus
3	PT100 – 1 (T <sub>input</sub> )	1 pair 3-conductor Pt100 (heat measurement) W terminals: Sense lines (cables of the same polarity / colour) R-Terminal: GND cable (different colour cable). For 2-wire Pt100, bridging the sense connections.
	PT100 – 2 T <sub>output</sub>	
4	REL	Relay connection, passive, potential-free
5	ANA 1 IN ANA 2 IN	Analogue inputs: 4 ... 20mA Unit signal, 24VDC, active (optional passive)
6	ANA 1 OUT ANA 2 OUT	Analogue outputs: 4 ... 20mA Unit signal, 24VDC, active (optional passive) from CTRL 2.1 according to Namur NE43 (3.8-20.5 mA)
7	IMP 1 IMP 2	Digital output (open collector: 20, 40, 60, 100, 260, 500ms square pulses) <b>IMP2 Only 2-channel transmitter usable</b>
8	RESET	Hardware-Reset (Restart of the system)
9	USB	USB Interface (Mini-USB Type B), access to the integrated SD memory card (Windows: Automatic detection as mass storage medium)
10	DIP 1 DO DIP 2 DO	DIP Switch for configuring IMP1 and IMP2 active / passive <b>IMP2 only 2-channel transmitter usable</b>
11	PE N L1 V+ V-	Two power supply options available: alternating current 90 ... 240 V / AC, direct current 18 ... 36 V / DC

### 5.3 Connection notes

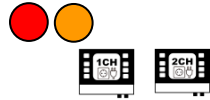

To access the deltaxwaveC-F cable space, please detach the four screws and remove the cover plate:

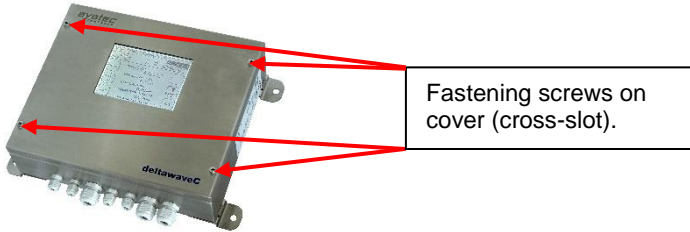

**Figure 2:** Remove cover from cable compartment



Please always make sure to put the correct voltage to your deltaxwaveC-F. Improper supply voltage might seriously damage the flow transmitter.

**You can check the type of power supply at the name plate, printed on right side of enclosure of flow transmitter.**

**All in- and outputs (except relay) have defined potential on the internal devices ground. For potential free operation of the in- and outputs additional hardware is needed (with galvanic isolation). With the normal in- and output it is not possible!**

- The analogue in- and outputs are active ex works 24V/DC (could be set in passive mode by systemc controls)
- The maximum permitted load of the relay is 45V, 0,25A

**Table 1: Recommendations for cable contacts**

description	recommendation	
In-/Output	Cross-section:	0.13 – 1.3 mm <sup>2</sup>
	Diameter:	0.4 – 1.3 mm
	Contact length:	6.0 mm
Power-supply	Cross-section:	0.5 – 4.0 mm <sup>2</sup>
	Diameter:	0.8 – 2.3 mm
	Contact length:	8.0 mm

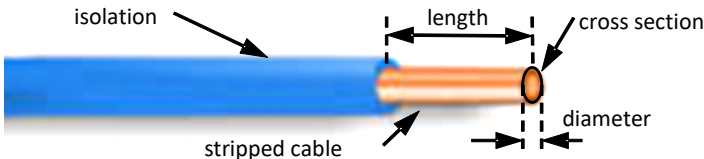

**Figure 3:** Cable assembly



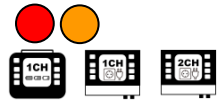

## 6 Operating

### 6.1 Control Buttons

- 1 Switches the device On and Off. To shut down the device, press the button for duration of approx. 3 seconds and then release it. No function on deltaxwaveC-F
- 2 Switches the backlight On and Off
- 3 Multifunctional buttons: Activate the function displayed beneath the button.

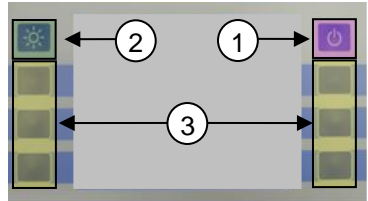

### 6.2 How to navigate

Use the corresponding multifunctional buttons:

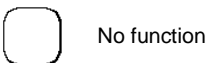
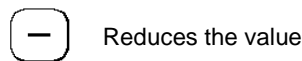
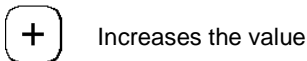
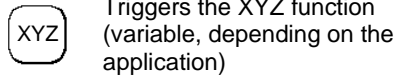
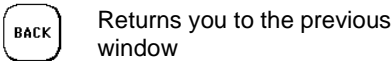
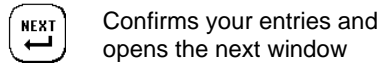
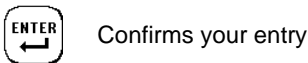

### 6.3 Select measurement channel



The operation of the 2-channel transmitter differs from conventional operation only (in a large part) through an additional selection of the relevant channel / measuring path.

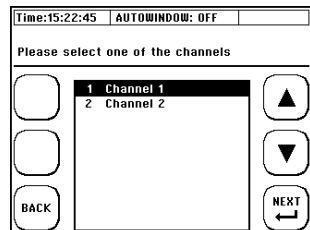



## 7 First Start

### 7.1 Basic settings, main menu, navigation

#### 7.1.1 Adjustment of the display language

1. Plug in the device.

→During the starting sequence please press the multifunctional key next to the section “SETUP LANG.”.

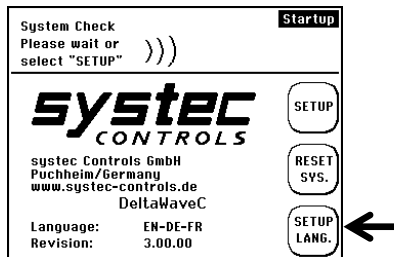

2. In the window choose the required display language using the arrow keys. Confirm your input by pressing “ENTER”. Leave the menu with “ESC”.

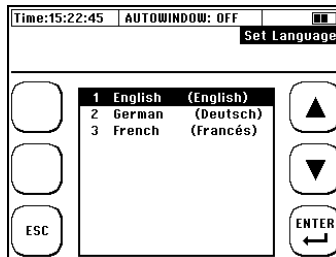

To change the language via the main menu, see Chapter 11.7.3.



With the language setting, you change the language in the menus. The language in the boxes next to the multifunction buttons remains largely unchanged.

#### 7.1.2 Navigation in main menu

After switching delatwaveC-F/P on and passing through the start screen, the measuring window “Flow 1” will appear automatically after few seconds. The measuring window “Flow 1” shows an overview of all necessary information for the measurement of flow and heat quantity.

1. Select “SETUP”.

If the required window does not appear after pressing “SETUP”, please check if the password function is deactivated.

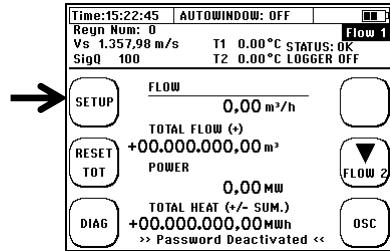

2. If you can see this window, please choose “COMPL SETUP”.

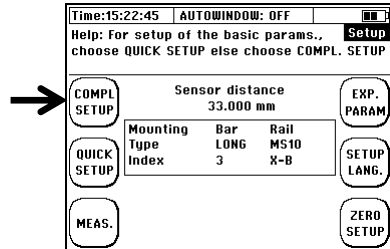

3. You are in the main menu now. From this menu all necessary functions of the device can be selected.

4. To return to the measuring window please proceed as follows:  
Choose “ESC” -> in the following window please select “MEAS”.

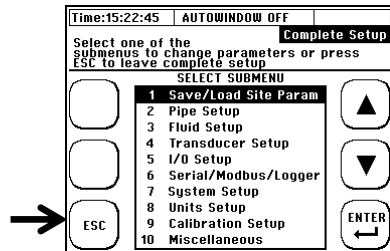

Now you have become acquainted with the basic operation of your deltaxwaveC-F/P.

**i** There is a trick to reach the main menu even faster after switching the device on: select “SETUP” during the start sequence right after switching your deltaxwaveC-F on. In the following window choose “COMPL” SETUP”.

### 7.1.3 Setting time and date

Having chosen the language for the menu you are in the main menu of the device.

1. Select the menu item (7) “System Setup” using the arrow key.

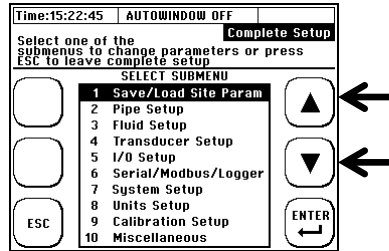

2. In the following window choose menu item (1) Time and Date.

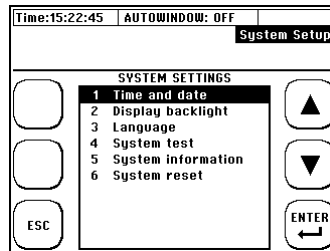

3. By using the arrow keys the position can be changed, by using +/- the value can be adjusted. Please enter the time and date according to the format displayed.

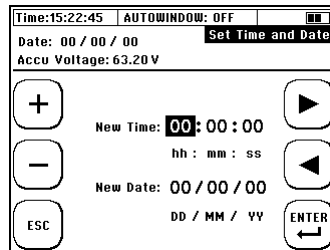

4. Subsequently, press “ENTER” to confirm your input and return to the system settings.

## 8 Preparing for measurement deltaxwaveC-F/P

Set-up your flow measurement in 5 steps

1. Choose suitable mounting position for your transducers
2. Parameterize your flow transmitter
3. Mount ultrasonic transducers onto your pipe
4. Set zero point (if possible)
5. Start your flow measurement

## 8.1 Preparation of the measurement / installation location

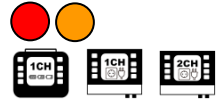

### 8.1.1 Inlet and outlet distances

The selection of the mounting location has a considerable influence on the quality of the measurement. Especially the inlet and outlet distance. Please consider the recommendations in the table below. The letter "D" stands for the pipe diameter.

Classification	Upstream side	Downstream side
90° bend		
Tee		
Diffuser		
Reducer		
Control valves		
Pump		



The distance “L” is defined as the distance from a fitting (e.g. a 90° bend) to the middle of the position of the ultrasonic transducers.

Example: 90° bend (at upstream side) at the inlet, 90° bend (at downstream side) in the outlet.  
Diameter of the pipe: 110 mm

Recommendation according to the chart.  
Running-in distance: 10D inlet = 10 x 110 mm = 1100 mm  
Running-out distance: 5D outlet = 5 x 110 mm = 550 mm



**What happens if the recommended inlet and outlet sections cannot be complied with?**

With simple pipe bends or T-pieces a reduction of inlet or outlet distances leads to a greater uncertainty of measurement. The closer to the fitting the transducers are mounted, the greater the measurement error will be.

With higher velocities of flow, a shortened inlet section can also lead to lasting disturbance of the flow profile which can induce a measurement failure. If there is a temporary measurement failure and there is no possibility to change the mounting position of the ultrasonic transducers, then the recommendation is to use the next higher ultrasonic transducer type even with small pipe sizes:  
F10 Transducer from DN32...DN200  
F05 Transducer from DN200

Pumps or flaps/valves produce permanent disturbances of the flow profile, which are not improved by switching to a different transducer type. In this case, the recommended inlet/outlet distances should be adhered to consistently.

### 8.1.2 Basic principles for ultrasonic transducer assembly



**The pipe always has to be completely filled at the mounting positions of the ultrasonic transducers!  
Measurement of partially filled pipes is not possible!**

The ultrasonic transducers can be mounted vertically or horizontally or in any other position. This is conditional on compliance with the possible mounting positions shown below:

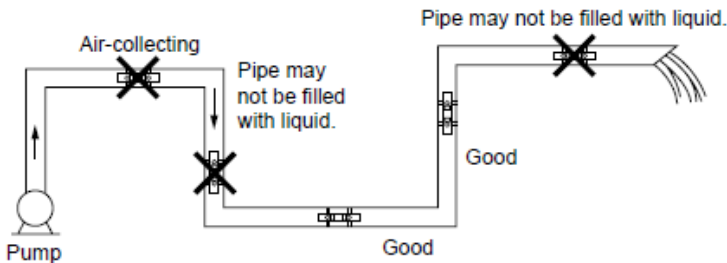
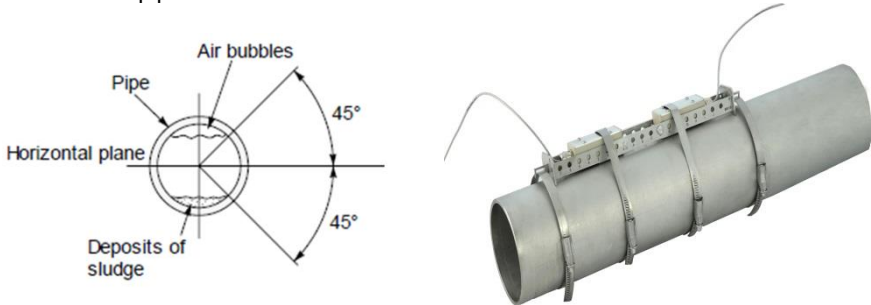

Figure 4: Preferable mounting positions for ultrasonic transducers (1)

### 8.1.3 Ultrasonic sensor Mounting on horizontal pipelines

On horizontal piping, it is recommended to mount the transducer with an offset of approx. +/-45% to the horizontal plane. This is based on the fact that there is a risk of the accumulation of bubbles in the upper section and sedimentation in the lower section of the pipe.



**Figure 5:** Preferable mounting positions for ultrasonic transducers (2)

Note on deposits in the pipeline, e.g. Lime:

The flow rate calculation of the deltaxwaveC-F / P is based on the following formula.

$$Q = L \frac{(\Delta t)}{t_2 \cdot t_1 \cdot 2 \cos \alpha} \cdot k_{Re} \cdot \frac{D^2}{4} \cdot \pi$$

The red-marked term can be seen that the deltaxwaveC-F/P the entire pipe cross-section includes in the calculation. Your deltaxwaveC-F/P calculates the pipe cross-section based on the parameterized values from your tube circumference or tube diameter and wall thickness. If lime scale deposits occur within the pipeline, they reduce the measurable cross-section through which the fluid flows. This will add an additional measurement uncertainty.



Especially if the pipe is unknown and/or the documentation of the application is missing, measuring the thickness of the pipe wall can be reasonable. In this case, systemec Controls offers you the precise pipe wall thickness measuring device deltaxwaveC-WD.

### 8.1.4 Ultrasonic transducer on uneven surfaces

Avoid mounting the sensors on uneven surfaces such as welds or deformations. For pipes with thick and uneven protective paint, remove it as far as possible at the points on which the ultrasonic transducers are mounted.

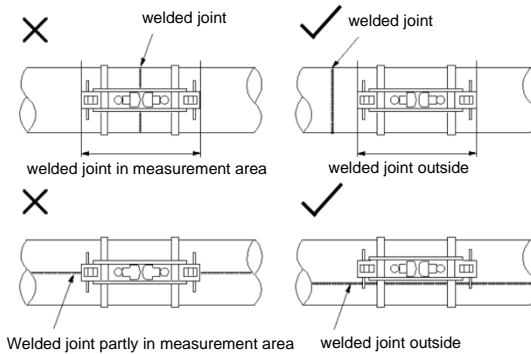

**Figure 6:** Preferable mounting positions for ultrasonic transducers (3)

## 8.2 Fundamentals of parameterization



The Parameterization chapter defines the input of all data that is necessary for flow measurement.

1. „**QUICK SETUP**“: The Quick Setup guide offers step-by-step instructions on the essential tasks you have to complete for deltaxwaveC-F/P parameterization. This Quick Setup is quite sufficient for handling most applications and gets you started with fast and efficient parameterization in no time at all.
2. „**CMPL SETUP**“: The complete setup function enables access to all options and expert settings. Here, you can also directly access individual parameters via the main menu.



## What needs to be parameterized?

1. The pipe's outer diameter or circumference.
2. The wall thickness of the pipe. The material and thickness of the pipe lining if such lining exists.
3. The pipe material
4. The medium
5. The type of ultrasonic transducers
6. The mounting mode for the ultrasonic transducers



Ultrasonic measurement is based on the signal transit time process. The ultrasonic signals penetrate the piping and the medium. In order to calculate the signal transit time, each medium, piping material and existing lining will be assigned a sonic speed value, as well as the pipe diameter or circumference value.

The deltaxwaveC-F/P has stored tables in which the sound velocities of materials and media are stored. If the material or medium is not listed in the tables, its sound velocity must be entered manually. At the end of this manual, you will find tables with additional sound velocities for different substances.

### 8.3 Parameterization with the Quick Setup



**How to access the parameterization dialog:**

**After power on:** Select „Setup“ → „Quick Setup“

**In the primary measuring window "Flow 1":** Select "Setup" → "Quick "Setup".

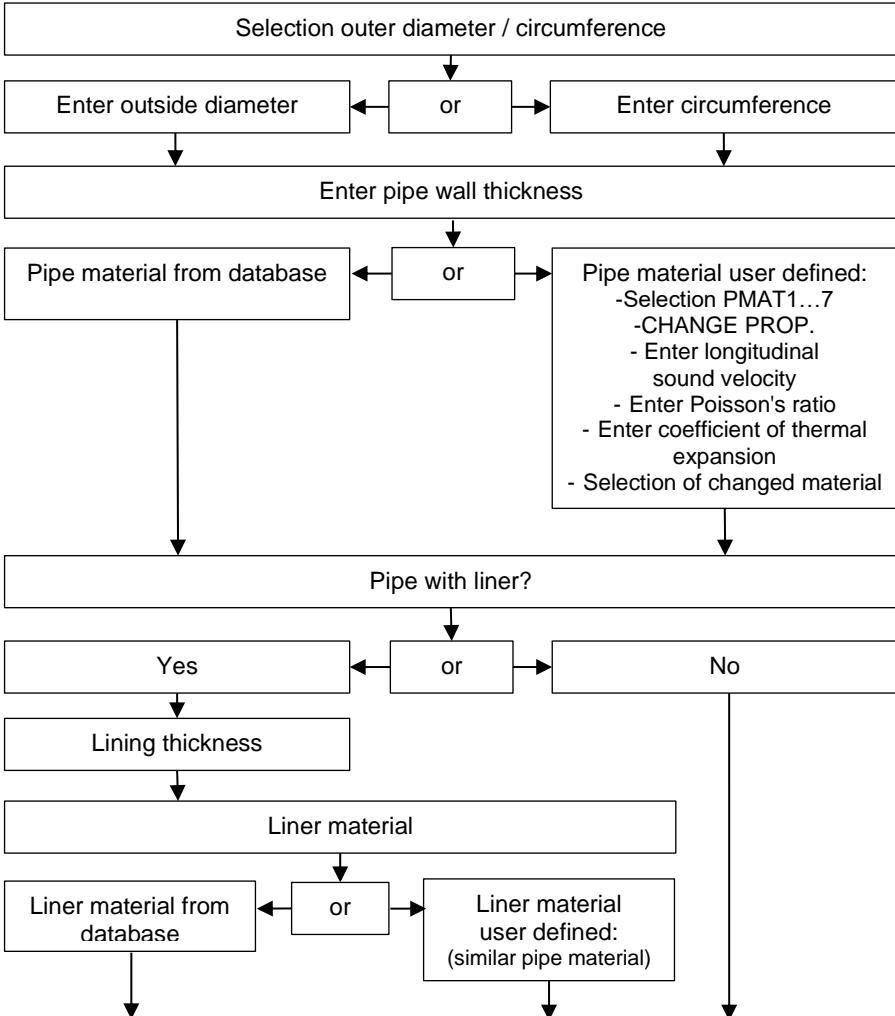

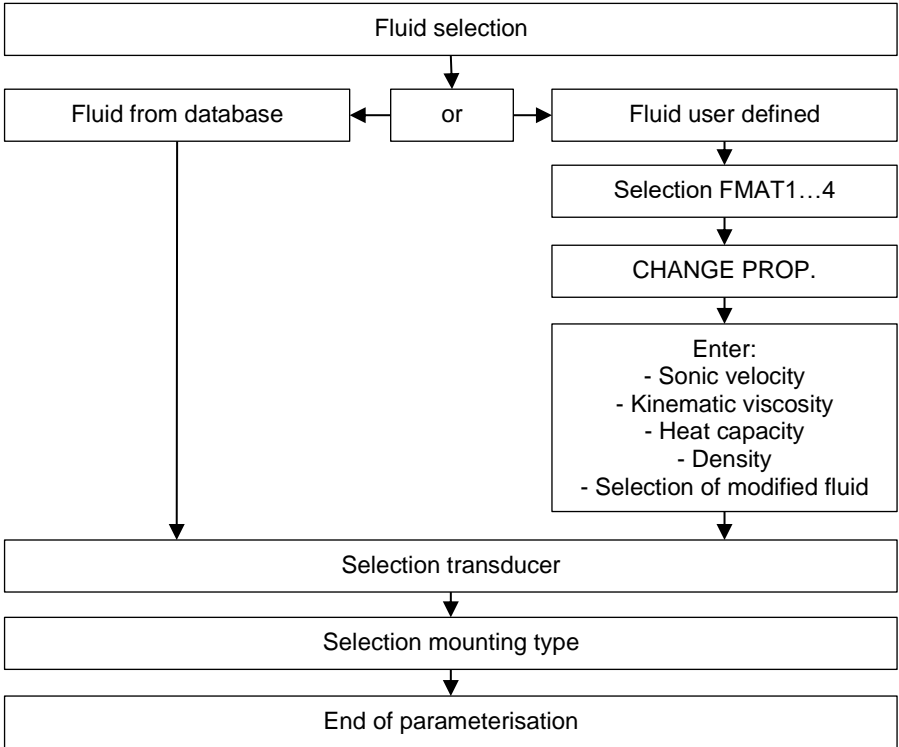

Definition of sensor distance see chapter 8.4

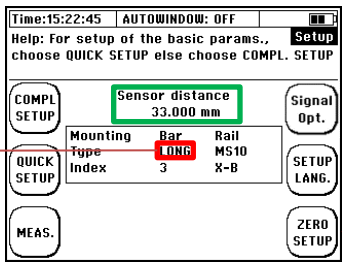

Before you start measuring we highly recommend a zero setup (if possible)



**Important!**

Please do always take care which mounting bar for transducers is displayed. The displayed one bar must be used:

Short = 25cm, hole distance 7,5mm, (XUC-FW F21, F40)  
Long = 40cm, hole distance 15mm, (XUC-FW F10)

## 8.4 Sensor assembly / Sensor distance



The distance between the ultrasonic transducers is always measured between their opposing surfaces in all mounting modes. Once you have completed the parameterization of the measuring point, the flow transmitter displays the distances that have to be set up using a measuring tape. When using a spacer bar in the so-called V-mode, you can position the transducers conveniently by means of the spacer bar.

### 8.4.1 Structure of ultrasonic transducers

Principle composition of the ultrasonic transducers:

Ultrasonic transducers (F05, F10 and F21/F40) is beige and made of plastic (PEEK).

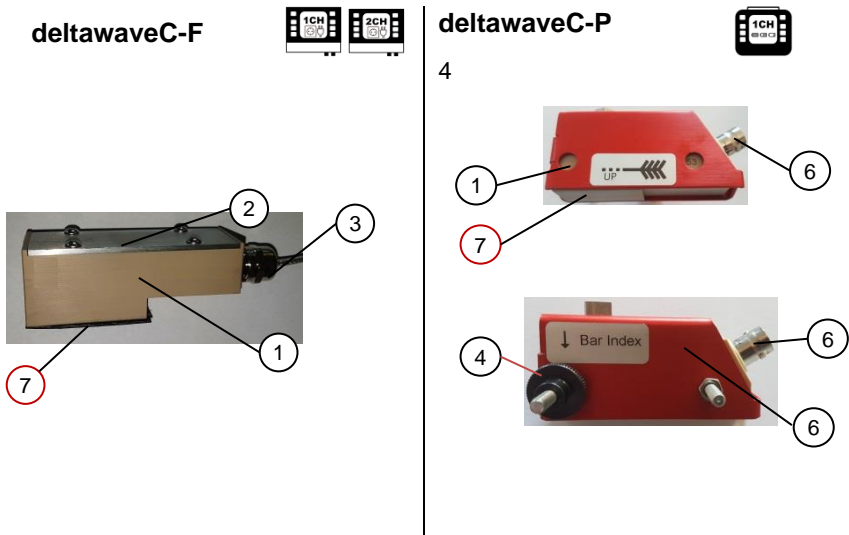
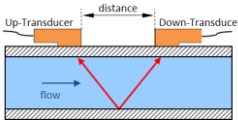

**Figure 7:** Principle composition of the ultrasonic transducers: 1: basic body, 2: cover, 3: connection cable (RG316), 4: knurled screws for fixing on the mounting rail, 5: Support housing for the "portable" version 6: BNC connector (RG58, female, "portable" type), 7: acoustic transmission surface

### 8.4.2 Mounting ultrasonic transducer

This chapter informs you of the possibilities for mounting the ultrasonic transducers. The V-mode is standard for most applications.

#### V-Mounting



V-mounting results in a measurement in most applications and is often the best compromise achievable signal quality and accuracy.

#### W- Mounting

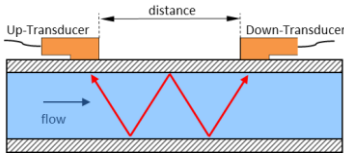

W-Mounting assembly is used when a measurement result which is as exact as possible and/or a high resolution is to be achieved.

In the case of small pipe sizes, this mounting type can also be useful due to the signal sensor separation.

#### Z- Mounting

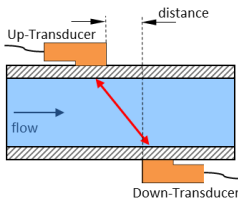

Z-Mounting assembly is due to the minimal signal path typically for large pipes or very dirty or gas-loaded media with high signal attenuation or signal dispersion for use contaminants.

#### **NO MOUNTING BAR**

In some cases Z-mounting results in successful measurements on small pipe diameters (< 20 mm) as well: if the received signals (pipe wall/V/W) can no longer be unambiguously unselected or when the correct reception signals in the measurement window cannot be uniquely positioned (look at 15.2.3)



**Figure 8: Z-mounting example, only possible without mounting rail (XUC-FW)**



**Figure 9: V- and W-mounting example with mounting rail (XUC-FW)**

### 8.4.3 Selection of transducer types

Below you will find a guide for the correct ultrasonic transducer selection, which has proven to be successful in practice.

Pipe diameter	Transducer	Systematic	Comment
<b>D &lt; 35 mm</b>	F40 Transducer	( ** )	
<b>35 mm &gt; D &lt; 80 mm</b>	F10 Transducer F40 Transducer	( ** ) ( ** )	
<b>80 mm &gt; D &lt; 110 mm</b>	F10 Transducer F40 Transducer	( ** ) ( * )	
<b>110 mm &gt; D &lt; 250 mm</b>	F10 Transducer	( ** )	
<b>250 mm &gt; D &lt; 400 mm</b>	F05 Transducer F10 Transducer	( ** ) ( * )	
<b>D &gt; 400 mm</b>	F05 Transducer	( ** )	

**Systematic: ( \*\* ) –Best selection; ( \* ) second best selection**



From September 2019, the 2 MHz (F21) transducers are replaced by 4 MHz (F40) transducer.

### 8.4.4 Selection of mounting options

Below you will find a guide for the correct choice of mounting options, which has proven to be successful in practice.

Pipe diameter	Mounting option	Systematic	Comment
<b>D &lt; 40 mm</b>	W- Mounting V- Mounting Z- Mounting	( ** ) ( * ) ( * )	Signal decoupling
<b>40 mm &gt; D &lt; 130 mm</b>	W- Mounting V- Mounting Z- Mounting	( ** ) ( ** ) ( * )	If the SNR is good Disturbed signal
<b>130 mm &gt; D &lt; 400 mm</b>	V- Mounting Z- Mounting	( ** ) ( * )	
<b>D &gt; 400 mm</b>	V- Mounting Z- Mounting	( ** ) ( * )	If the SNR is good

**Systematic: (\*\*) highest accuracy; (\*) higher signal strength**

**SNR: Signal-to-noise ratio**

### 8.4.5 Selection mounting rail

For the installation of the ultrasonic transducers type F10 and F40, mounting rails are available, which can be used for installation in V and W mode.

There are two different lengths of mounting bars with different grid dimensions:

**Short Bar** = 40cm, hole distance 15mm (only for F10 Transducer)

**Long Bar** = 25cm, hole distance 7,5mm (only for F40 Transducer)

	<p>Short and long mounting rail for permanently installed ultrasonic transducers:</p>
	<p>For applications with extra long sensor distance, an additional auxiliary rail is available:</p>
	<p>Short and long mounting rail for portable ultrasonic transducers:</p>

Which rail you have to select is shown on the display of the deltaxwaveC after the measuring point has been parameterised.

Type F05 ultrasonic transducers are mounted without a rail.

### 8.4.6 Selection coupling media

#### deltawaveC-F



For the long-term installation of transducers only the coupling pads are recommended.

Place **one** acoustic coupling pad between the acoustic transmission surface of the transducer and the pipeline for each ultrasonic transducer.

**Do not use any additional coupling media such as gels or pastes!**

Make sure that the coupling pads lie flat on the complete sensor surface.



Figure 10: XUC-FW F10 with acoustic coupling pad

#### deltawaveC-P



Turn the thumbscrew max out, so that the transducer base is located below the lower edge of the sensor carrier (V-profile)

Apply a peanut-sized drop of ultrasonic coupling gel (Magnalube) to the acoustic transmission surface (offset downwards) and rub it slightly.



Figure 11: Transducer with an approx. peanut-sized drop of coupling gel



The coupling gel allows a significantly better signal quality than the acoustic coupling pads. However, high temperature signal, the coupling gel may run and the acoustic signal coupling can be lost.

In this case a thermally stable coupling gel or acoustic coupling pad can be used - contact system Controls.

The coupling pads are stable long-term and allow for a sufficiently good signal quality in most cases when used correctly. Use acoustic coupling foil exclusively for ultrasonic transducers for fixed installation.

For optimum signal coupling, a higher contact pressure is necessary, which usually cannot be produced with the mounting means of the portable measuring device.



### 8.4.7 Transducer mounting

#### deltawaveC-F



The ultrasonic transducers are attached by stainless steel band on the pipeline. The stainless steel tensioning band is designed for the maximum diameter of the tube to be used for your ultrasonic transducer and tensioned via the tensioning buckle. The tensioning band can be shortened easily for smaller pipes.

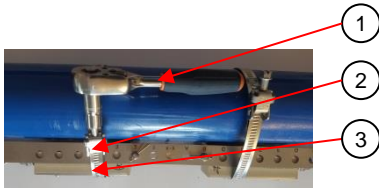
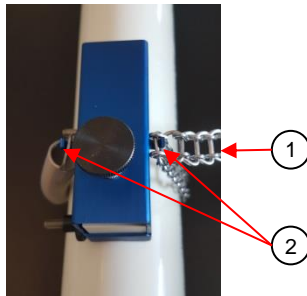

**Figure 13:** Mounting of XUC-FW with stainless steel band; 1: clamping tool, 2: clamping lock, 3: clamping band.

#### deltawaveC-P



To attach the ultrasonic transducers (with or without the mounting rail), use the stainless steel chains or hook-and-loop bands. The knurled screw is tightened in a clockwise direction until a slight pressure is applied



**Figure 12:** Mounting of XUC-PW with stainless steel chains; 1: tension spring, 2: hook for fastening

### 8.4.8 Mounting of the Transducer in V-Mode or W-Mode

After the parameterization of the measuring point, the transmitter shows the distance of the transducers in mm (marked green) and the number of holes (marked red) as well as the mounting rail to be used (marked blue). The number of holes is a reference quantity of the distance with simultaneous application of the mounting rails for the ultrasonic transducers F10 and F40

The deltaxwaveC might display following:

<b>Sensor distance</b>		
<b>63.20 mm</b>		
<b>Mounting</b>	<b>Bar</b>	<b>Rail</b>
<b>Type</b>	<b>Long</b>	<b>MS10</b>
<b>Index</b>	<b>4</b>	<b>X-C</b>

If 4 is displayed as the number of holes, then this corresponds:



After setting the cotter pins at "X" and at "C" the **number of holes between the ultrasonic sensors, including the positions at which the cotter pins are mounted:**

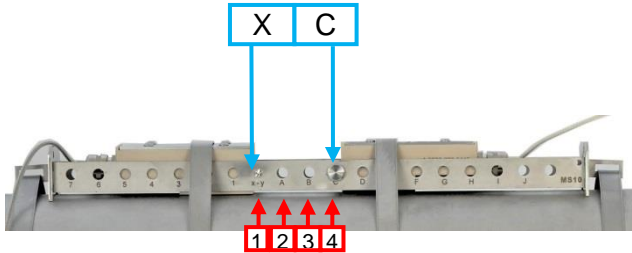

The **number of holes between the ultrasonic sensors, plus the position at which the knurled screw of the opposite transducer is mounted:**

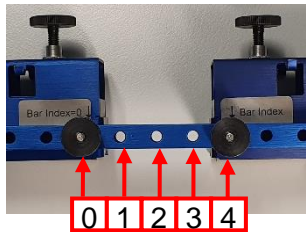

**If the wrong mounting rail is used or the wrong hole distance, the measurement does not work or incorrect values are displayed!**

### 8.4.8.1 Mounting permanently installed

#### 8.4.8.1.1 Mount the Rail on the Pipe

Select an appropriate mounting position on the pipe (see chapter 8.1) and fasten the rails on both sides with the steel belts (see red marked areas).

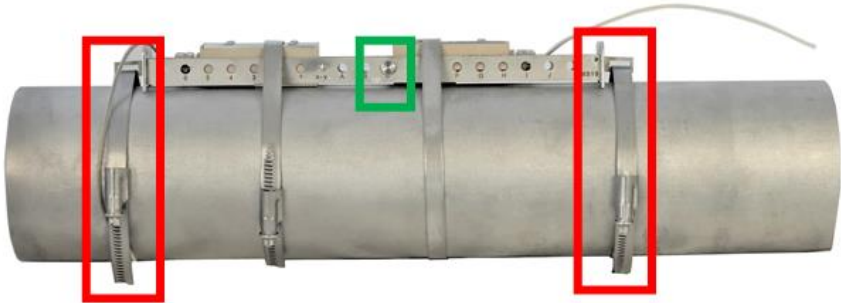

#### 8.4.8.1.2 Install the cotter pin to the correct position

You have to install the cotter pin according to the displayed mounting instructions. Related to the shown example ("X-C"), the pin needs to be installed to the "C" position (see the green marked area above). The cotter pin at position "X" can be omitted, as a cotter pin is already firmly welded in here.

#### 8.4.8.1.3 Place the transducers in the rail

Place the transducer with the selected coupling media (see chapter 8.4.6) into the rail and push the front of the transducer against the cotter pin.

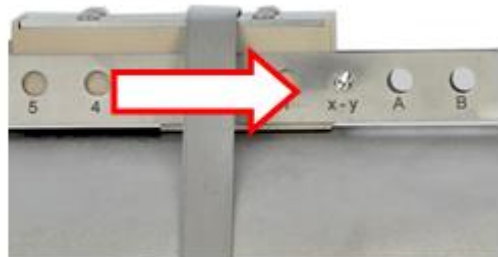

Then repeat this with the opposite transducer.

### 8.4.8.1.4 Mounting the Transducers

Last step, fix the transducers at the correct position with the attached steel belts (red marked).

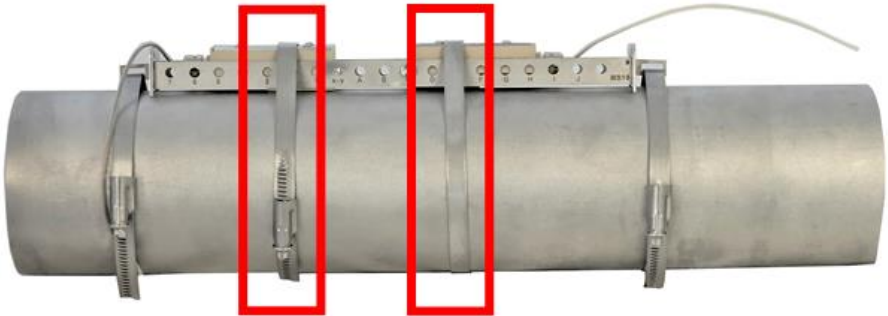

### 8.4.8.2 Mounting portable

#### 8.4.8.2.1 Attaching the transducers to the mounting rail

Open the knurled screws of the ultrasonic transducers and insert the threads in the specified hole spacing (see chapter 8.4.7) through the specified mounting rail (see chapter 8.4.7). Then fasten the transducers to the rail by screwing on the knurled screw.

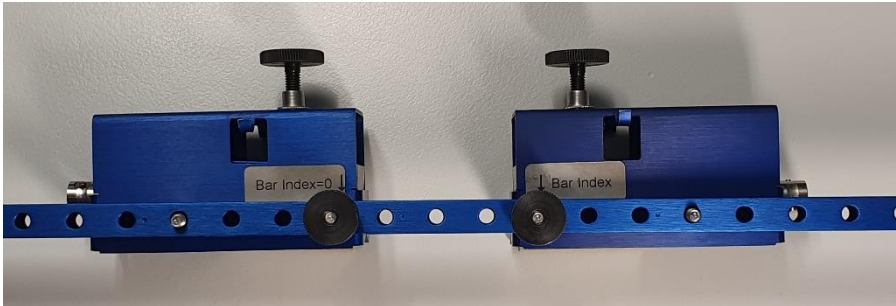

### 8.4.8.2.2 Mounting the transducers on the pipe

Provide the transducers with the selected coupling media (see chapter 8.4.6).  
Select a suitable mounting position on the pipe (see chapter 8.1) and place the rail with the ultrasonic transducers on the pipe.



### 8.4.8.2.3 Fastening the transducers

Then fasten the transducers with the enclosed fastening accessories. Type F10 transducers can be fastened with the enclosed tension chains. Type F40 transducers can be fastened with the enclosed Velcro straps.

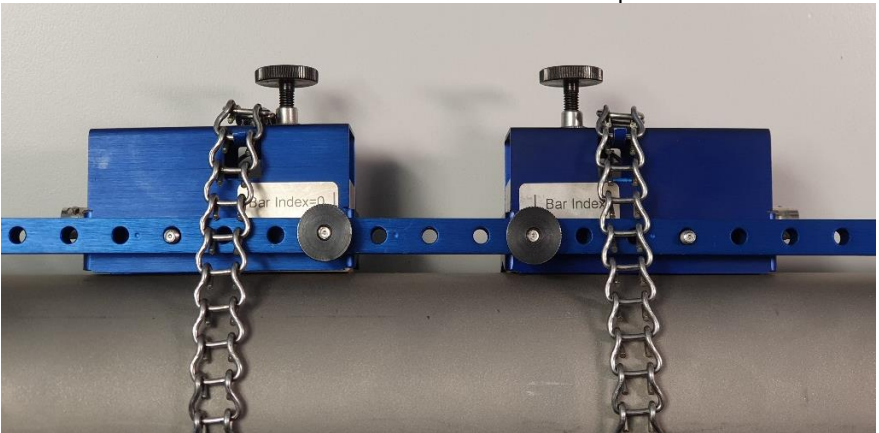

For ultrasonic transducers of type F10, the knurled screw is then tightened clockwise until a slight contact pressure is created.

### 8.4.9 Mounting the ultrasonic transducers based on the Z method

Use a plastic or paper template to mark the mounting positions.

1. Wrap the plastic template once around the pipe at the mounting position of the first ultrasonic transducer. Using a felt tip pen, draw a line on the pipe along the template (corresponds with the pipe circumference)

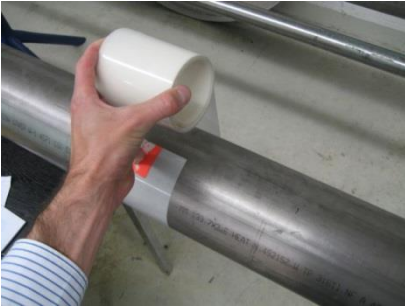

**Figure 14:** Attaching the template tape

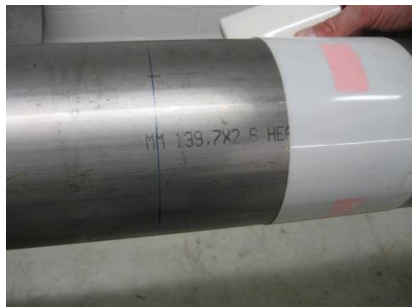

**Figure 15:** Mark the circumference

2. • On successful completion of parameterization, your deltaxwaveC-P/F displays the axial distance between the ultrasonic transducers (transducer distance). Measure the transducer distance based on the value displayed on your deltaxwaveC-P/F, starting from the first line drawn on the pipe to the position at which the second line is to be drawn.



**Figure 16:** Mark the distance between transducer



**Figure 17:** Mark the circumference for the second transducer.

- 3. On the circumference lines, select two exactly opposite positions.
- 4. Mount the first sensor to the centre of mark 1.
- 5. Measure out the half of the pipe circumference along the circumference line from mark 2 and apply marking 3.

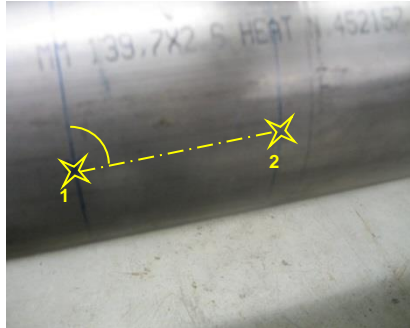
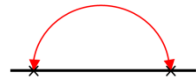

Figure 18: Opposed marks 1 & 2 at the circumference lines

$$U_{1/2} = \frac{2 \cdot \pi \cdot r}{2}$$



- 6. Mount the second sensor to the centre of the sensor front (not the sensor) at mark 2 (see Figure 19 & Figure 20). The sensors are now exactly opposite.



Figure 19: Mark the position of the second transducer at half circumferential distance

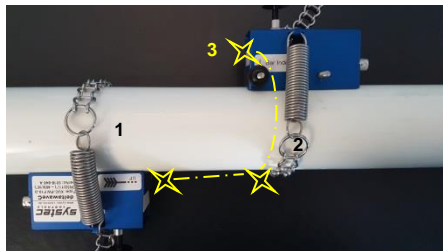

Figure 20: Mounted transducer, Z-mounting

### 8.4.10 Mounting transducer with two mounting rails

For this type of installation, an auxiliary rail is required in addition to a regular mounting rail. It can be used for fixed installation of transducers in Z mode or for installations with large distances.

The setup display could show the following in these cases:

Sensor distance 378.20 mm		
Mounting Type Index	Bar	Rail

In this case no mounting instructions for bars or rails are displayed. Only one instruction is available, the sensor distance of 378.20 mm. The displayed value is the distance between the transducer fronts.

#### 8.4.10.1 Mounting Z-mode with two rails

The installation procedure is analogous to the procedure in chapter 8.4.8.1, except that the second transducer in the auxiliary rail is offset 180 ° to the opposite side of the pipe.

Mount the rail and one transducer on the pipe as shown in the figure below (part A) and measure the distance between the transducers and mount the second transducer in the opposite rail (part B) in the same procedure as the first transducer.

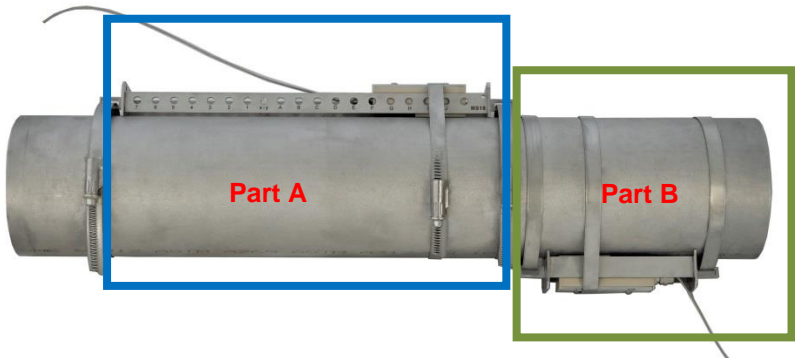



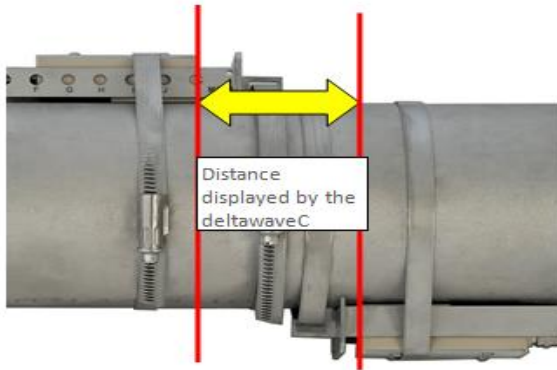

If you have problems positioning the transducers, mark the positions of the transducers as described in chapter 8.4.9.

### 8.4.10.2 Mounting at large distances

Mount the rail and a transducer on the pipe as shown in the illustration (part A). Now measure the distance between the transducers and mount the "auxiliary rail" in the correct position (part B).

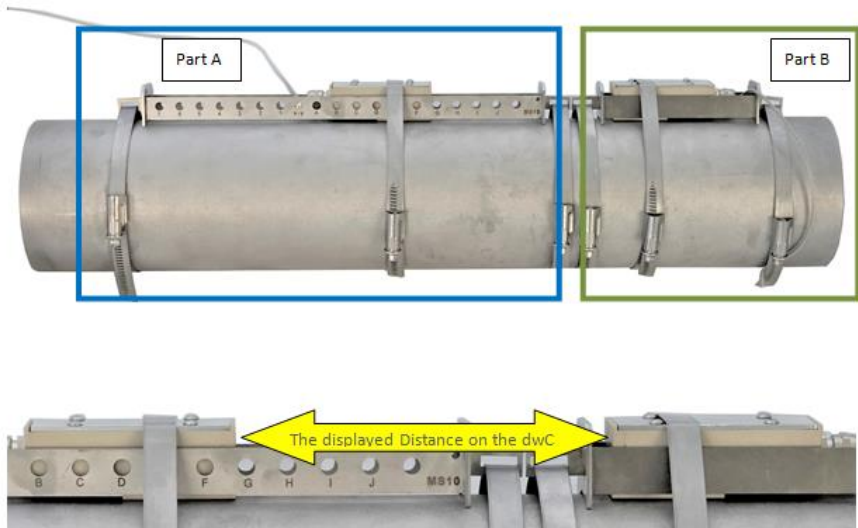



### 8.4.11 Mounting the ultrasonic transducers at two crossed measuring paths

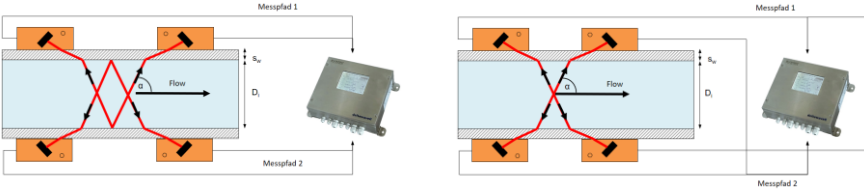

The mounting type of both pairs of transducers must be the same (V-mounting, W-mounting or Z-mounting). It is not possible to combine different mounting methods.

For Z-mounting the transducers of the respective pair must be offset by 180°. For V and W mounting, the transducers of the respective pair are mounted on the same side of the tube. Installation instructions for the exact alignment at 180° offset can be found in the Z-type mounting aid (8.4.8.1).

### 8.5 Alternative sensor distance

There are several reasons why you may need to change the sensor distance. Be it due to lack of space or you get not a good signal at the calculated distance. For this you can enter an alternative sensor distance. This is how you get there.

**From the main menu "COMPL. SETUP  
"outgoing":**  
"Miscellaneous" → 8 "Sensor distance"

There, set ASD to "active" and enter the new distance.

With the "plus and minus buttons" you can activate and deactivate the alternative sensor distance and enter below the value.

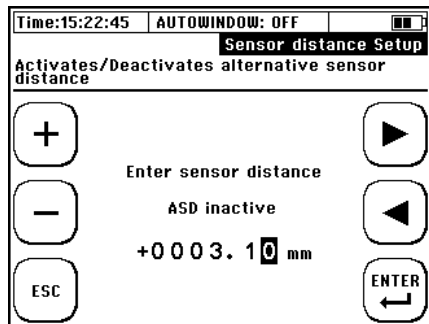

Please note that you should not make any extreme changes from the original value because the signal will not be recognized correctly.

## 8.6 Zero Setting



Before starting the measurement, we recommend performing a zero calibration.



Prerequisites for zero-point calibration are:

- that the device is configured correctly and that both ultrasonic transducers are mounted properly on the pipe and electrically connected to the transmitter
- the line is completely filled
- the flow rate is zero

If all prerequisites are fulfilled, perform a zero-point calibration, otherwise, do not perform a zero-point calibration!

An incorrect zero point adjustment will have a more negative impact on the measurement result than no zero adjustment!

Procedure:

1) Ensure zero flow

2) **Navigation after switching on:**

„Setup“ → „Zero- Setup“ → „Set Zero“

**From the measuring window "Flow 1" outgoing:**

„Setup“ → „Zero Setup“

**From the main menu "COMPL. SETUP" outgoing:** „Miscellaneous“ → „Zero“ → „Set Zero“

3) The zero point adjustment starts automatically. Wait until the counter reaches the value "0" again.

4) After confirming (ENTER) the time correction of the zero point adjustment, you are returned to the "Setup" window.

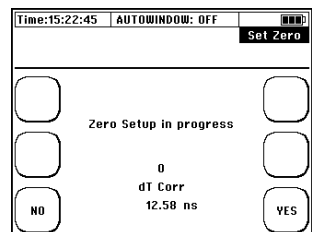
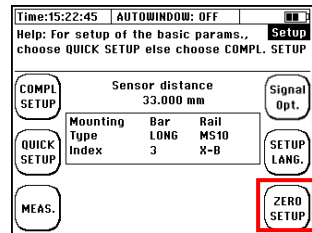

Typical values for the zero point adjustment are generally in single-digit range.

If you receive a "time correction" in two-digit range (and more), you can assume that a (residual) flow was present during the zero-point adjustment.

**The zero point will be automatically deleted when relevant parameters (pipe, medium, transducer, frequency and signal coding) have been edited again (in this sense, editing also includes a renewed confirmation without changing the values). A signal optimisation (with**

**the exception of the zero point optimisation) also leads to the deletion of the zero point. Pay attention to this, e.g. when you carry out series measurements with different application data!**

You can check the detected zero point by navigating from the "Flow 1" measurement window to the diagnostic window. In the measurement window, select "Flow 1" → „DIAG“

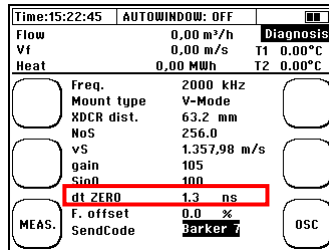
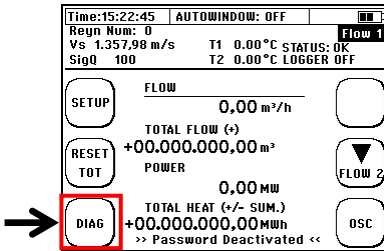

The zero point remains stored in the device until it is automatically overwritten with a new zero offset or has been removed manually by "Delete zero".  
The time correction value of the zero point adjustment is an essential part of the parameter structure (see 11.1 Saving/Loading parameter data).



For zero-point calibration, your deltaxwaveC-F/P determines the run-time difference at zero flow, which can arise between the sensors and, if necessary, a flow which is still present.  
This determined time (dt ZERO) is automatically compensated in the flow measurement. This increases the accuracy of your flow measurement. dt ZERO is sign-loaded - a subsequent exchange of up- and down-transducers would thus double the error. The ultrasonic sensors are paired at the factory and have a very low zero point error (typically <2 ns).  
A zero flow rate cannot be guaranteed at every position of the pipeline system. When installed carefully, this error is in the range of 0.00-0.03 m / s flow velocity. The larger the pipeline is, the smaller is usually the zero point error.

## 8.7 Signal optimisation

### 8.7.1 Open signal optimisation

On the mobile device (C-P), the signal optimization is located on the top right button of the start screen.

For the permanently installed devices, the parameters are under COMPLETE SETUP → "10 Miscellaneous" → "11 Signal Optimization"

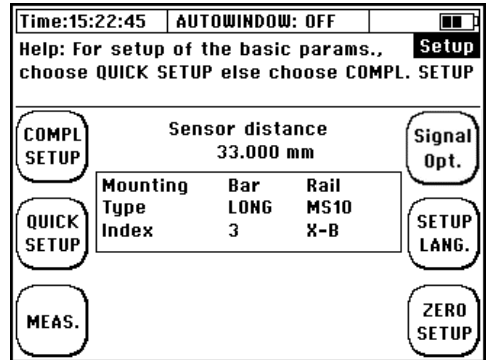

### 8.7.2 Functionality Signal Optimisation

The signal optimization is an automated search in which the coding (Barker5; Barker7 etc.) and the frequency are modulated in order to achieve the most stable measurement. The Correlation Clearness (CC value) and, depending on the mode, also the zero point or the gain are important for this.

You can see the process screen on the right. After pressing "START OPT." The device automatically starts the search.

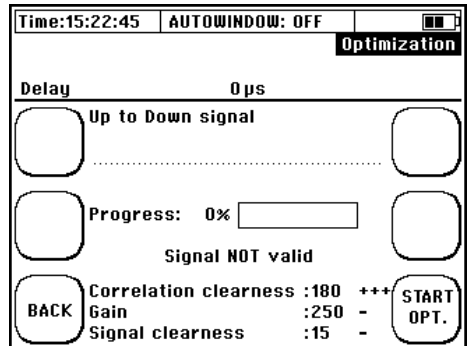

As long as the optimization process is running, you cannot do anything on the device. The search takes between one and five minutes depending on the type of transducers used and the diameter of the pipe.

If the note "CC-Warn" appears on the display (see chapter 10.1) during a measurement, the value of the "Correlation clearness" falls below 10 (standard value). In this case, please carry out a signal optimization.

### 8.7.3 Gain-Optimization

**(can be used during flow of medium)**

The gain-optimization can be activated as described in point 8.7.1. During the gain-optimization it is applied a combination of coding and frequency, which requires the lowest gain AND has a CC value higher than 20. This type of optimisation usually delivers the best results, which is why it has been placed on the start screen of the deltaxwaveC-P.

### 8.7.4 Zero-Optimization

**(have to be used in absolute standstill of medium)**

The zero-optimization can be found on the start screen under Zero Setup → “4. ZERO optimization”.

In the case of zero-optimization, a combination of coding and frequency is applied that has the smallest deviation from the zero point AND has a CC value higher than 20.

Before the zero-optimization is started, the medium should stand still for a reasonable time (e.g. in DN 80 pipe more than a minute) so that the optimization can run without any errors.

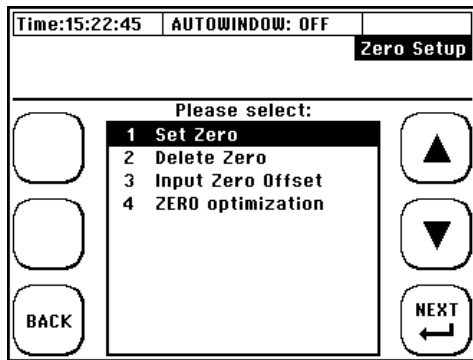

## 9 Heat measurement



The integrated heat quantity measurement allows you to determine the heating or cooling power in your application using with the optionally available Pt100.

### 9.1 Introduction

The Pt100 No. 1 is mounted on the input side ( $T_1 = T_{in}$ ), Pt100 No. 2 at the output of the process section ( $T_2 = T_{out}$ ). The placement of the ultrasonic sensors is irrelevant as long as the volume flow is equal. There should be a pipe section to be selected with optimal inflow / outflow (look at chapter 8.1.1).

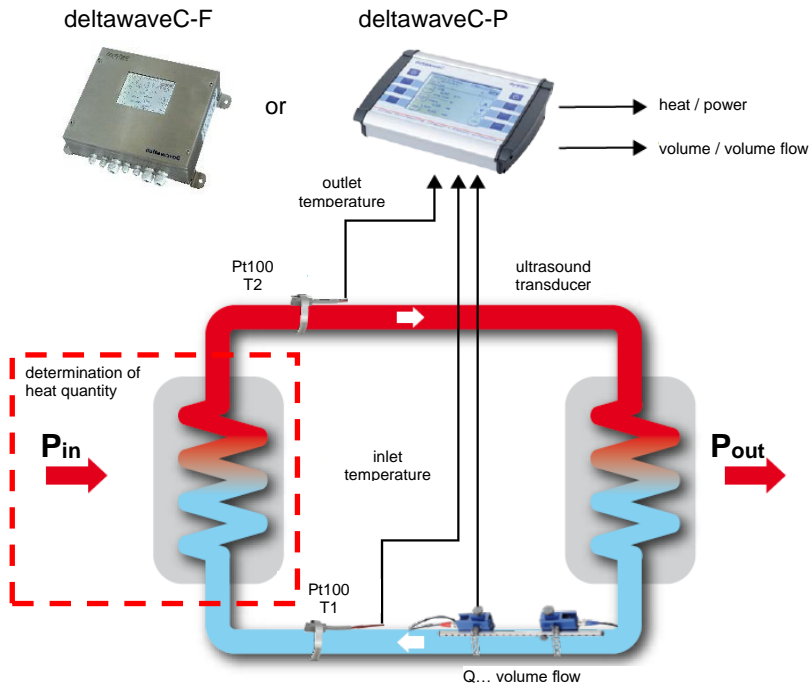

**Figure 21:** Scheme of heat quantity measurement

The deltaxwaveC-F/P shows you the heat output and the accumulated heat quantity.

### Calculating thermal output

The cross-sectional area of the pipe's inner diameter [A] is multiplied by the flow velocity [v] and specific thermal capacity of the medium [c<sub>w</sub>], as well as the differential temperature of both Pt100, [T<sub>out</sub> – T<sub>in</sub>]. The product defines thermal output [Q] in W units.

$$Q = A \cdot v \cdot c_w \cdot \rho \cdot (T_{out} - T_{in}) \qquad Q = [kW]$$

### Calculating heat (quantity)

The heat quantity is derived as a function of thermal output over time.

$$Q = \int \dot{Q} dt \qquad Q = [J, kW / h]$$

## 9.2 Installing the Pt100



The Pt100 are mounted on the pipeline using the supplied stainless steel tapes.



Figure 22: At pipe mounted Pt100



For the determination of the heat quantity the determination of the correct temperature difference is important (relative measurement). This means that the temperature readings can deviate absolutely relative to a reference (for example, against an immersion thermometer).

It is important to calibrate both Pt100 and to ensure that both Pt100 show the same measured value in a volume of the same temperature (the difference between the Pt100 before the installation on the pipeline should be zero degree). To ensure this we recommend observing chapter 9.3 before installation.

The thermal insulation or the use of thermal grease during assembly of the Pt100 can significantly reduce the measurement uncertainties when determining the temperature difference.



### 9.3 Parameterization of the Pt100 for the heat quantity measurement

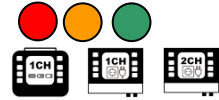

We recommend that both temperature sensors be immersed in a tube with liquid for approx. 2...5 minutes (the liquid should be at room temperature) before the tubes are mounted on a pipeline. Avoid touching the probes in advance of the calibration. To check the calibration, please use the display in "Measuring window 3", "Heat quantity", as the temperature difference between T2-T1 is displayed in this measuring window.

After calibration, the temperature difference should **not be**  $> 0.2 \text{ }^{\circ}\text{C}$  ( $2 / 10\text{K}$ ). If the temperature difference is higher, repeat the calibration procedure.

**Further information on the parameterization of the Pt100 can be found in the chapters 11.9.2, 11.9.3 and 11.10.1.**

In addition to the zero adjustment, the individual temperature readings can be offset (adjustment to reference value / compensation of deviations).



Example: In the pipeline there is a resistance thermometer which shows  $80^{\circ}\text{C}$ . However, your deltaxwaveC-F/P contact resistance thermometer Pt100 shows only  $78.5 \text{ }^{\circ}\text{C}$ . The difference can be corrected manually. In this case, you specify a default value of  $80 \text{ }^{\circ}\text{C}$ . The default value is an absolute value and no offset.

The parameterized clamped value is valid for both Pt100. For low measuring dynamics and small temperature differences between Pt100 No. 2 and No. 1, it is recommended to increase the Pt100 clamping value. An increase in the clamping has a positive effect on the stability of the temperature difference measurement.

# 10 Measuring windows deltawaveC-F/P



## 10.1 Headline

The header is the same for each of the three measurement windows and displays basic values and status messages:

- 1) General information
- 2) General measurement values
- 3) Name of the UI window
- 4) Status display
- 5) Status display for communication / Logger

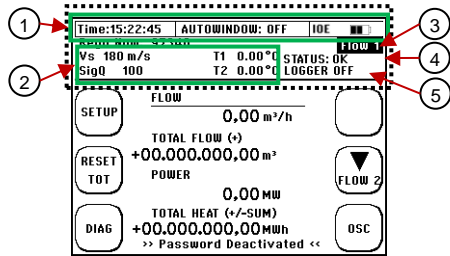

Display		Explanation
Gen. Inform.	<b>Time</b>	Format: hh:mm:ss
	<b>AUTOWINDOW ON / OFF</b>	Auto window function
	<b>IOE</b>	Indicates that the memory for the pulse output is full and the pulse output is disabled (look at chapter 11.5.4).
		Battery condition: Battery is charging; 50-100%; 25-49%; 10-25%; <10%
	<b>NO SD Card</b>	No SD card detected. Possible reasons: Removed for data readout, defective, unsupported card size used.
Value	<b>Vs</b>	Sound velocity of medium in m/s
	<b>SigQ</b>	Signal quality (percentage of valid signals)
	<b>T1 / T2</b>	Temperature values of the Pt100
Communication	<b>MODBUS ON / MODBUS OFF</b>	Status for the MODBUS communication. Priority over SER SST. status. If you have an M-Bus version, M-Bus will be displayed in this field
	<b>SER. SST. ON / SER. SST. OFF</b>	Status display for serial communication. Priority over LOGGER status.
	<b>LOGGER ON / LOGGER OFF</b>	Status display for the data loggers. Priority over USB status.
	<b>USB ON</b>	Indicates that the USB interface is connected to an external master.
	<b>QLOGGER ON</b>	Indicates that the Quick Logger is active.
Measure	<b>OK</b>	Everything OK. Valid signals are evaluated.
	<b>NO SIG</b>	No valid signals present.
	<b>Error</b>	Problems with the ultrasound board. Possible reasons: defective, DSP update necessary.

Measure	VS ERR	0.8 * Vs parameterized <Vs> 1.2 * Vs parameterized Possible reasons: wrong signal (W instead of V, V instead of W)
	VP / VL ERR	Error in the calculation of the signal propagation.
	CC-WARN	Correlation clearness value falls below the standard value of 10. Signal optimisation should be carried out.

## 10.2 Measuring window "Flow 1"

In the flow measurement window 1 you get all the important information, compactly summarized for your flow, heat output and heat quantity measurement.

### Navigation in the User-Interface:

- 1) Approximately 10 seconds after switching on, it will automatically switch from the home screen to the central measuring window "Flow 1".
- 2) **From the main menu, starting:**  
Select "ESC" → then "MEAS".

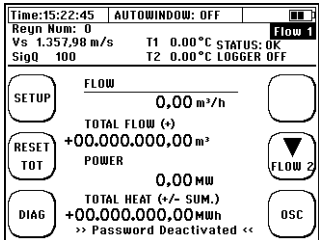

Display	Explanation
<b>FLOW</b>	Displays the current volume flow
<b>TOTAL FLOW</b>	Totalizer flow = flow meter (Summed up volume) Parameterizable types: Sum counter (+), negative counter (-), absolute counter (+/- sum), difference counter (+/- diff)
<b>POWER</b>	Displays the current heat output.
<b>HEAT TOTAL</b>	Totalizer heat quantity = heat quantity counter (Summed heat quantity) Parameterizable types: Sum counter (+), negative counter (-), absolute counter (+/- sum), difference counter (+/- diff)
<b>Password activated/deactivated</b>	Status of password protection.



Switch to the setup window



ONLY portable: activates the Quick-Logger



Sets the totalizer (flow and heat quantity) to zero.



Change to measuring window "Flow 2".



Switch to diagnostic window.



Switch to the oscilloscope window.

### 10.3 Measuring window "Flow 2"





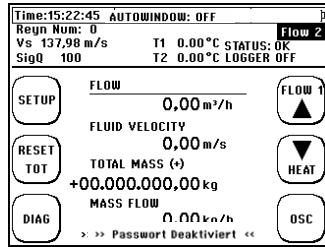

In the flow measurement window 2 you get all the important information, compactly summarized for your flow measurement (without heat measurement).

**Navigation in the User-Interface:**

From the main measurement window "Flow 1" outgoing: Select "Flow 2"



Display	Explanation
<b>FLOW</b>	Displays the current volume flow
<b>Fluid VELOCITY</b>	Indication of the flow velocity of the medium in the pipe
<b>TOTAL MASS</b>	Totalizer mass flow = mass flow meter (accumulated mass flow) Parameterizable types: Sum counter (+), negative counter (-), absolute counter (+/- sum), difference counter (+/- diff)
<b>MASS FLOW</b>	Displays the current mass flow
<b>Password activated/deactivated</b>	Status of password protection.

-  Switch to the setup window
-  Sets the totalizer (flow and heat quantity) to zero.
-  Switch to diagnostic window.
-  Change to measuring window "Flow 1".
-  Change to measuring window "heat quantity".
-  Switch to the oscilloscope window.

## 10.4 The measuring window "heat quantity"

In the "Heat quantity" measurement window, you get all the important information, compactly summarized for your heat quantity measurement.

### Navigation in the User-Interface:

From the main measurement window "Flow 1" outgoing: Select "Flow 2" → then „Heat“

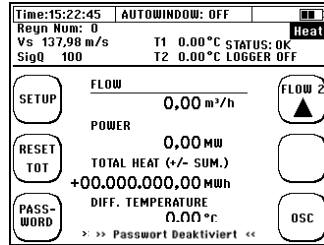

Display	Explanation
<b>FLOW</b>	Displays the current volume flow
<b>POWER</b>	Displays the current heat output
<b>HEAT TOTAL</b>	Totalizer heat quantity = heat quantity counter (accumulated heat) Parameterizable types: Sum counter (+), negative counter (-), absolute counter (+/- sum), difference counter (+/- diff)
<b>DIFF. TEMPERATURE</b>	Displays the currently measured temperature difference
<b>Password activated/deactivated</b>	Status of password protection.



Switch to the setup window



Change to measuring window "Flow 2".



Sets the totalizer (flow and heat quantity) to zero.



Switch to the password window (Activation / deactivation)



Switch to diagnostic window.



Switch to the oscilloscope window

## 10.5 Password protection

The deltaxwaveC-F/P is equipped with password protection. After enabling password protection, it is only possible to switch between the measurement windows and the password display. Parameters or totalizers cannot be changed when password protection is activated.

### Activation of the password:

To access the password display, navigate to the last measurement window. The following screen is the password window.

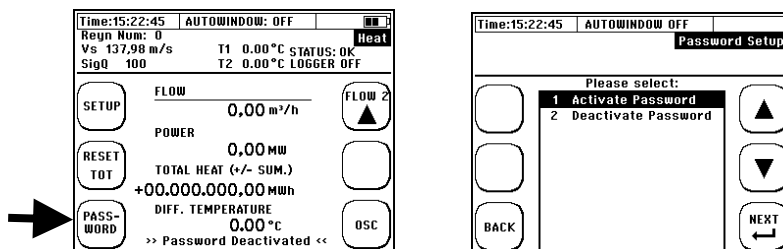

Please select "Activate password" or "Deactivate password" and confirm the function with the "Enter" key.

Edit the number code by using the arrow (navigation), as well as "+" and "-" (increase/reduce) buttons. Press "ENTER" to confirm the entered password. For security reasons, a second password request is made. Re-Enter the code and confirm. After that the password protection is activated or deactivated depending on the function selected.

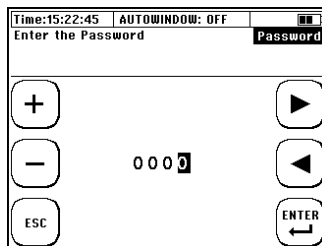

If you have lost/forgotten your password and you can't deactivate password protection, then please contact systemc Controls.

## 10.6 The measurement windows of the 2-channel deltaxwaveC-F



### Navigation in the User-Interface:

1) Approximately 10s after power-up the screen automatically switches from the start screen to the central measurement window "CH1 / CH2".

2) From the main menu: Choose "ESC" → then "MEASURE."

### CH1/CH2

Time:15:22:45		AUTOWINDOW: OFF	
Vs CH1 : 1,542,00 m/s	Sig0 CH1 : 100	Vs CH2 : 1,542,00 m/s	Sig0 CH2 : 100
Stat. CH1 : OK	T1 : 0.0°C	Stat. CH2 : OK	T2 : 0.0°C
SETUP	FLOW CH1	0.00 m <sup>3</sup> /h	
RESET TOT	TOTAL FLOW (+) CH1	+00,000,000.00 m <sup>3</sup>	
DIAG	FLOW CH2	0.00 m <sup>3</sup> /h	CH1 & CH2
	TOTAL FLOW (+) CH2	+00,000,000.00 m <sup>3</sup>	
	FLUID VELOCITY	CH1 0.00 CH2 0.00 m/s	OSC
	>> Password Deactivated <<		

### CH1&CH2

Time:15:22:45		AUTOWINDOW: OFF	
Vs CH1 : 1,542,00 m/s	Sig0 CH1 : 100	Vs CH2 : 1,542,00 m/s	Sig0 CH2 : 100
Stat. CH1 : OK	T1 : 0.0°C	Stat. CH2 : OK	T2 : 0.0°C
SETUP	FLOW CH1 + CH2	0.00 m <sup>3</sup> /h	CH1 & CH2
RESET TOT	TOTAL FLOW CH1 + CH2	+00,000,000.00 m <sup>3</sup>	
DIAG	FLOW CH1 - CH2	0.00 m <sup>3</sup> /h	CH1 & CH2
	TOTAL FLOW CH1 - CH2	+00,000,000.00 m <sup>3</sup>	
	FLOW (CH1+CH2)/2	0.00 m <sup>3</sup> /h	OSC
	>> Password Deactivated <<		

### (CH1+CH2)/2

Time:15:22:45		AUTOWINDOW: OFF	
Vs CH1 : 1,542,00 m/s	Sig0 CH1 : 100	Vs CH2 : 1,542,00 m/s	Sig0 CH2 : 100
Stat. CH1 : OK	T1 : 0.0°C	Stat. CH2 : OK	T2 : 0.0°C
SETUP	TOTAL FLOW (CH1+CH2)/2	+00,000,000.00 m <sup>3</sup>	CH1 & CH2
RESET TOT	POWER (CH1+CH2)/2	0.00 MW	
DIAG	HEAT (CH1+CH2)/2	+00,000,000.00 MWh	INPUT
	TOTAL MASS (CH1+CH2)/2	+00,000,000.00 kg	
PASS-WORD	MASS FLOW (CH1+CH2)/2	0.00 kg/h	OSC
	>> Password Deactivated <<		

The individual results are shown in the individual measurement windows in terms of flow velocity, volume flow, totalizer (volume and heat quantity) and power. Either for the individual channel or according to the illustrated calculation (sum, difference or mean value)

	Switch to the setup window		Switch to the password window (Activation / deactivation)
	Sets the totalizer (flow and heat quantity) to zero.		Switch the measurement channel „CH1&CH2“
	Switch the measurement channel „CH1/CH2“		Switch the measurement channel „(CH1+CH2)/2“
	Switch to diagnostic window. (after CH-Selection)		Switch to the oscilloscope window

# 11 The main menu (complete menu)



## 11.1 Loading, saving and managing parameter data



### Navigation in the User-Interface:

From the main measurement window "Flow 1": select „SETUP“ → then „COMPL SETUP“ → select „Save/Load Site Param“

Your deltaxwaveC-F/P offers you the possibility to save, load and display all relevant parameters. This saves time when you need to perform measurements of recurring measuring points.

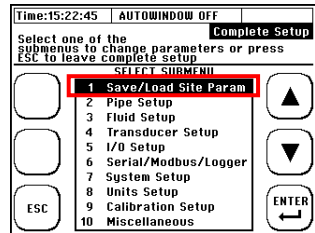

Via the "file access", up to 9 parameter sets can be stored and made available as a parameter file ".PAR" on the SD card. The format corresponds to a text file ("\*.txt") and can be visualized and edited at any time via a text editor or a spreadsheet program.

To select a parameter set, use the arrow keys to select a memory location and confirm with "Next".

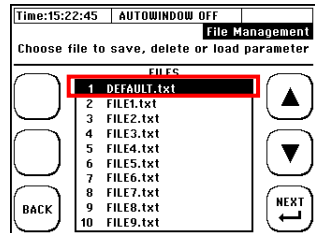

You now have the option to check all parameters before saving. The parameter data is distributed over 7 measurement windows. To switch between the parameter data, use the arrow key.



### IMPORTANT

The parameter overview shows the current contents of the PAR file. To ensure that the content matches the current parameters, the current parameter set must first be saved in the corresponding file.

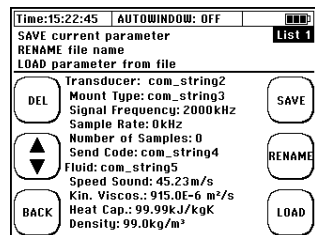



- |  |   |  |                                 |
|--|---|--|---------------------------------|
|  | Resetting the PAR file name and content |  | Save the current parameter data |
|  | Switch between the overview windows     |  | Switch to edit file name        |
|  | Back to file list                       |  | Loading the PAR content         |

**Edit the file name:**

- 1) Use the arrow keys to select characters that correspond to the PAR file name (**max. 7 characters**)
- 2) Press "ENTER" to confirm the selection of a character
- 3) "DEL" clears the last character.
- 4) Exit by navigating to "DONE" and confirm with "ENTER"

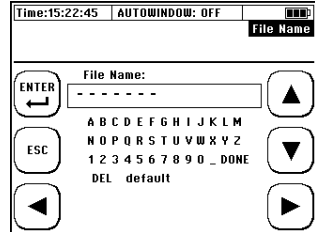

The new name is only accepted when the "Save" function is activated in Overview 1.

The "Default.PAR" file is regularly overwritten with the current parameters (cyclical saving of the current settings) so that this memory space should not be used.

The parameter data are stored from firmware 1.33.x on the device-internal SD memory card and can be exported via USB.

The copying / saving of parameter files from the device-internal SD card are only possible via the USB interface. As soon as the transmitter is connected to a PC via USB, the SD card is recognized as an external data memory and data can be exchanged.



The system **only registers "known"** PAR files.

If a parameter file is to be transferred from a deltaxwaveC-F/P (device 1) to a different device (device 2) via USB, it must be ensured that the name of the PAR file is assigned to one of the names from the list of Device 2 (see file access, e.g.: FILE1.PAR). The file (device 2) can then be directly replaced / overwritten.

Systemc Controls recommends storing and backing up parameter sets of important or recurring applications. This saves time and enables fast, efficient assistance in cases support where support is needed.

Since mid-2018, a software tool is available that allows convenient creation and editing of parameter files. This software is included on the USB stick.

## 11.2 The pipe parameters



### Navigation in the User-Interface:

From the main measurement window "Flow 1":  
select „SETUP“ → then „COMPL SETUP“ → select  
„Pipe Setup“

The pipe parameters are part of the Quick Setup (mandatory parameters) but can also be edited individually via the main menu.

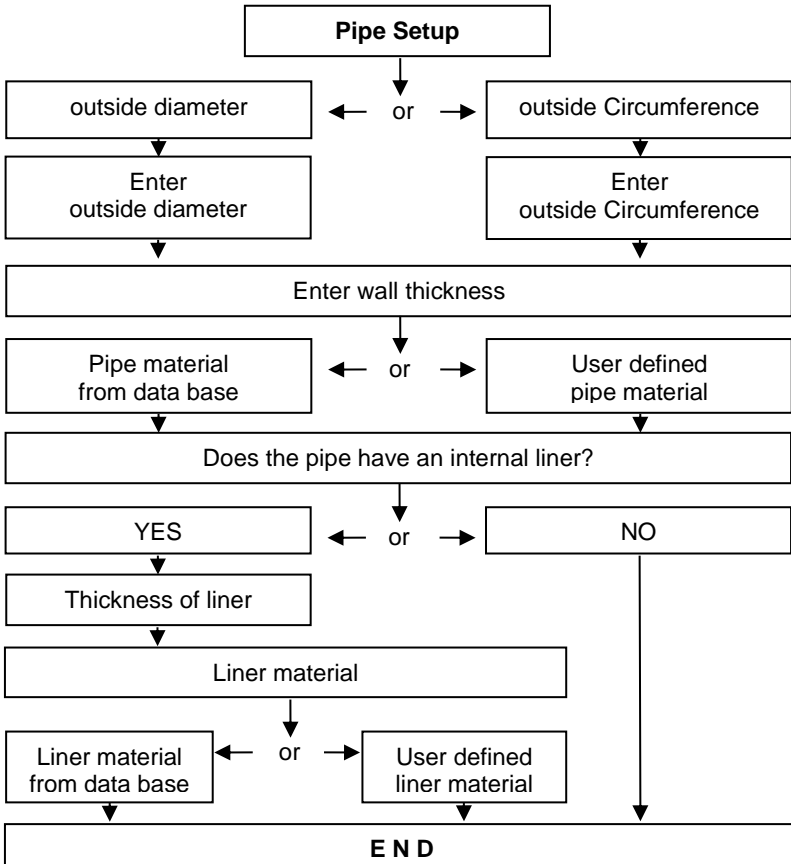
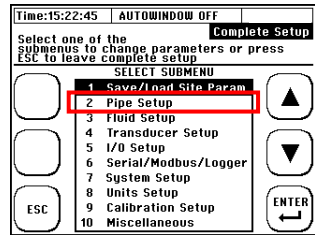

**Parameterization of a user-defined pipe material:**

Scroll down in the material database (tip: 1x arrow up).

Here are freely editable materials:

**Pipe:** 7x PMAT

**Pipe Lining:** 4x LMAT

Both the name and the properties can be changed with these materials. However, this option only becomes active when you use the arrow function keys to one of the freely editable materials.

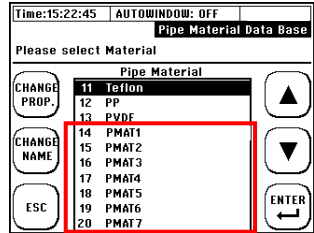

To edit a custom material, you need:

- 1) Sound velocity (longitudinal)
- 2) Poisson's ratio
- 3) Enter Coefficient of thermal expansion

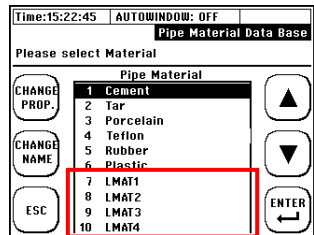

User-defined materials are only available on the unit and cannot be exported via the parameter file. If a parameter file with a user-defined material is loaded into a unit in which the material is not available, only the material selection is set to "PMAT" or "LMAT". In the case of missing parameterisation of the property values of these materials, this can lead to incorrect measurements.

### 11.3 The Fluid Setup



**Navigation in the User-Interface:**

**From the main measurement window "Flow 1":** select „SETUP“ → then „COMPL SETUP“ → select „Fluid Setup“

The fluid parameters are part of the Quick Setup (mandatory parameters) but can also be edited individually via the main menu.

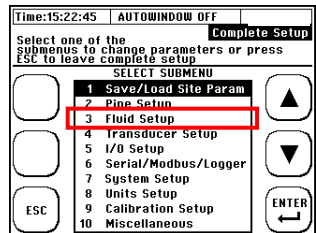

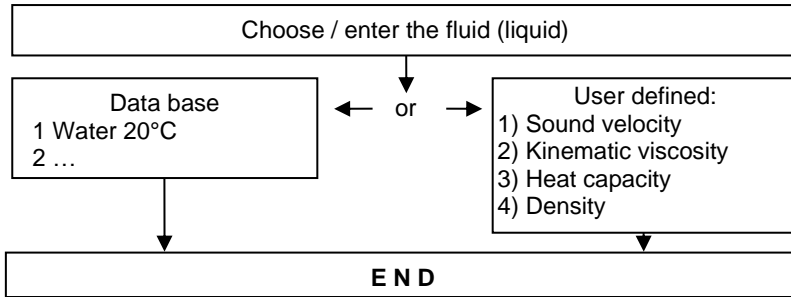

Currently, only four user-defined media can be parameterized.

For a successful, correct determination of the flow velocity, only the input of sound velocity and kinematic viscosity is necessary. Heat capacity and density are only necessary for the determination of the heat quantity and can be parameterized with 1 if not required.

If the kinematic viscosity is not available, you can also calculate it from dynamic viscosity and density (see Chapter 4, Reynolds number). Pay attention to the units!

User-defined media are only available on the unit and cannot be exported via the parameter file. If a parameter file with a user-defined medium is loaded into a unit in which the medium is not available, only the media selection is set to "FMAT". In the case of missing parameterisation of the property values of these medium, this can lead to incorrect measurements.

## 11.4 The Transducer Setup



### Navigation in the User-Interface:

From the main measurement window "Flow 1": select „SETUP“ → then „COMPL SETUP“ → select „Transducer Setup“

The transducer parameters are part of the Quick Setup (mandatory parameters) but can also be edited individually via the main menu.

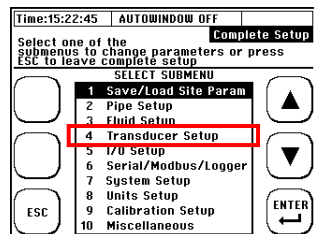

According to the conditions of application or the availability here select the transducer and mounting types. General information about the transducers and their installation, see chapter 8.4.

General recommendations regarding selection of transducer and mounting type see chapter 8.4.3 & 8.4.4.

Particularly under unfavourable conditions (old pipes, possibly with deposits, liquids with high absorption or with scattering particles or bubbles), the Z-mounting should always be considered as a second option in case of poor signal quality.

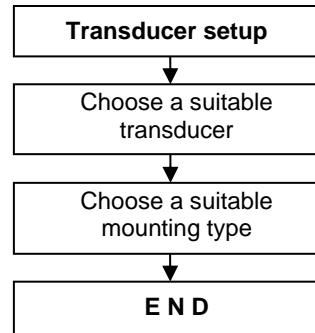

## 11.5 Parameterization of the inputs and outputs



### Navigation in the User-Interface:

**From the main measurement window "Flow 1":** select „SETUP“ → then „COMPL SETUP“ → select „I/O Setup“

Depending on the output you want to parameterize, select:

- Analog Output
- Relay
- Pulse Output

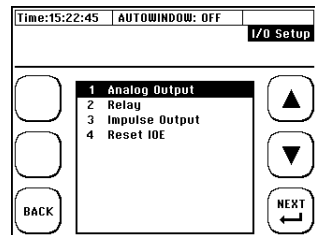

### 11.5.1 Parameterization of the 4-20mA outputs



The deltaxwaveC-F/P has a total of two 4-20mA outputs. You have the option to assign the outputs different metrics.

The outputs are active at the factory. This means that the deltaxwaveC-F provides a voltage at the outputs. You can also operate the analogue outputs externally (passively).

If you want to switch the analogue outputs passive, the device must be opened. In this case, please contact systemec Controls for further details. For external supply, the voltage may be within a range of 10 to 30V.

The analogue outputs are **not galvanically separated**. If the inputs of the evaluation unit require galvanic isolation, a feed separator must be connected between deltaxwaveC-F/P and the evaluation unit. There is also the possibility to feed two analogue values to the DeltawaveC-F/P, more details in the service manual.

deltawaveC-F/P feeds (approx. 24V)

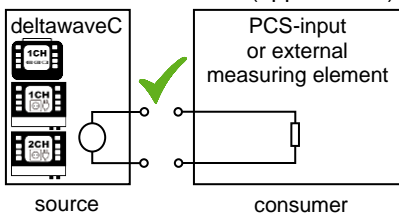

External unit feeds (approx. 24V)

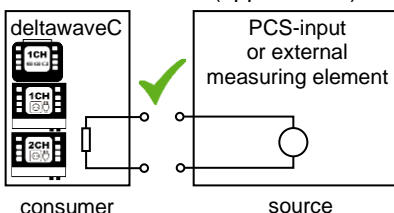

If the 4-20mA outputs of the deltaxwaveC-F / P are active and you connect the analogue outputs of the deltaxwaveC-F / P to an external device which also provides a voltage at the inputs, this can damage the deltaxwaveC-F / P or your external device. Before you connect the two devices, make sure that **only one of the devices is active!**

After you have decided to parameterize the analogue outputs, the navigation through further windows follows the sequence diagram on the right side.

The following measured variables can be assigned to the analogue output:

- Flow
- Flow rate
- Differential temperature T2-T1
- Temperature T1 or T2
- Heat output
- Sound speed
- T1 and  $\Delta t$
- Mass flow

The measured value values are edited in the parameterized units.

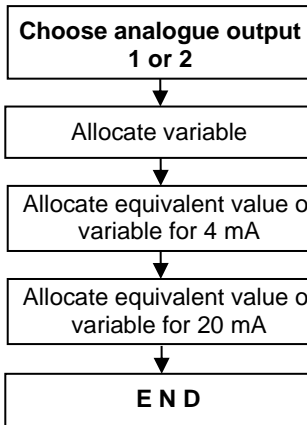



Measured values for the 2-channel: All measured values (except for exceptions are temperature and power) can be output separately according to measuring path (CH1, CH2). Special measuring variables for flow: CH1, CH2, CH1 + CH2, CH1-CH2, (CH1 + CH2) / 2. The power calculation is only for average measurement paths possible (1 measuring point, 2 measurement paths).

Extended current range:

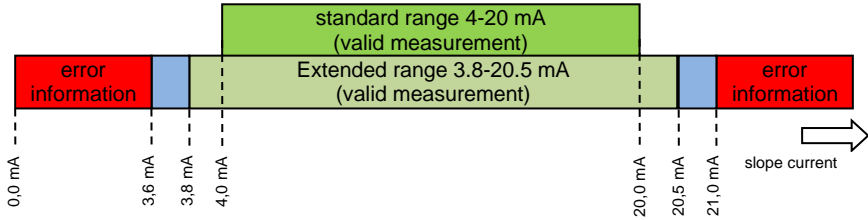

DeltawaveC-F/P is able to output the current in an extended range (NAMUR NE 43). The error current of the deltawaveC-F/P is about 3.4 mA.

## 11.5.2 Parameterization of the relay



Your deltaxwaveC-F/P is equipped with a relay output. You have the option to assign the output of a function and a range.

For example, it is possible to couple an alarm function to the output, e.g. the sign of a certain minimum flow.

Example for external circuit:

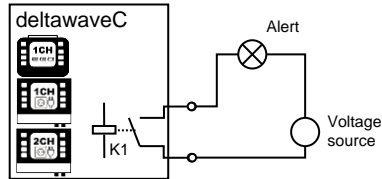

The relay operates without parameterization NO (normally open), the relay function is parameterized, then it is protected against wire breakage. This means that the relay opens only when a parameterized relay function is triggered. This has the advantage that in the event of a power failure (battery empty, no power supply) an alarm is triggered. The polarity of the connections must not be neglected. The contact is potential free. Max. Current: 0.5 A; Max. Voltage 50V

The navigation through the relay parameterization runs according to the sequence diagram on the right side. The measured variables are edited in the parameterized units.

The following measured variables can be assigned to the relay output:

- Flow
- Flow rate
- Differential temperature T2-T1
- Temperature T1 or T2
- Sound speed

For the 2-channel version, the assignment of special measuring variables is possible, see 11.5.1.

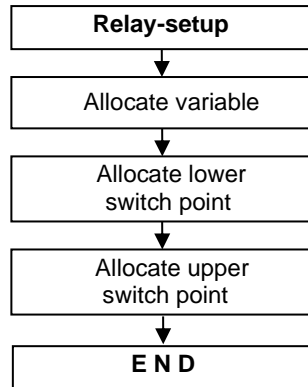

**Example:** In one application, a pump is operated where damage could occur when the flow under 150 m<sup>3</sup>/h. Ensure that flow rate is assigned to cubic meters per hour. Relay parameterized as a minimum switching point at 0m<sup>3</sup>/h and a maximum switching point 150m<sup>3</sup>/h. The relay contact is opened in the range of 0..150m<sup>3</sup> / h, the relay contact remains closed at > 150m<sup>3</sup>/h.





### 11.5.3 Parameterization of the pulse output

#### deltawaveC-F



#### deltawaveC-P



The pulse output is implemented as a transistor output (open collector) and is basically passive with deltaxwaveC-P (external supply: 3 ... 30V / DC). With deltaxwaveC-F, active operation of the pulse output is also possible.

The output form of the pulse is parameterized with the deltaxwaveC via the user interface.

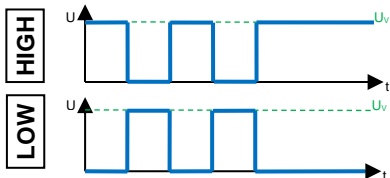

The navigation through the pulse parameterization runs according to the sequence diagram on the right. The measured variables are edited in the respective parameterized unit.

The following measured variables can be assigned to the pulse output:

- Flow rate (total volume)
- Heat quantity
- Total mass

Possible **pulse lengths**: 20, 40, 60, 100, 260, 500 ms

The 2-channel version has a second pulse output so that the totalizers can be assigned separately according to measuring paths (1CH, 2CH).

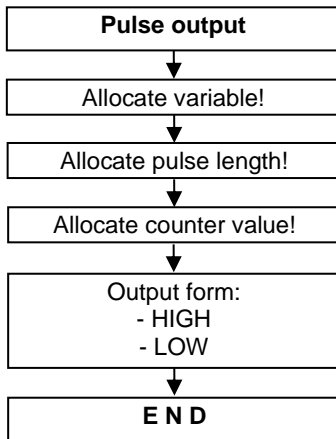

If the unit of the totalizer is changed after parameterization of the pulse output, the counter value is adapted. Numerical inaccuracies in the conversion can lead to deviations with frequent unit change.

## 11.5.4 Pulse-Overflow-Error; IOE



Occasionally, limiting cases can occur when using the pulse output: **The value of the selected pulse output parameter exceeds for a short time the maximum pulse number that can be emitted per second.** In this case the supernumerary pulses will be deposited in the internal pulse buffer of the device and emitted as soon as possible.

If the number of supernumerary pulses is bigger than the maximum size of the pulse buffer (max. 4096 pulses can be buffered), the pulse output will be deactivated and the error report **pulse Overflow Error (IOE)** will be displayed in the right column of the window header.

**As soon as the IOE error appears, no pulses will be output or buffered.** An IOE is an indicator that another pulse weight must be selected to make sure the pulse buffer will not be in overflow again.

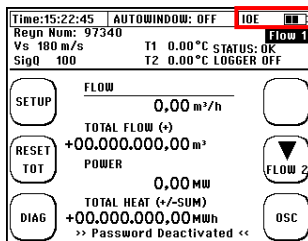

The digital display of the transmitter (volume, heat quantity) is not affected by a pulse overflow. The summed amounts are also displayed correctly in the case of an IOE.

A reactivation of the pulse output is possible by resetting the **"Reset IOE"** error via the I/O settings.

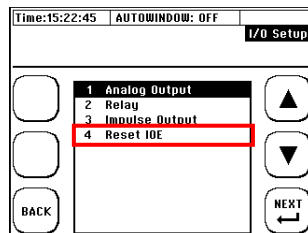

## 11.6 Serial communication, Modbus, MBUS & Logger

### 11.6.1 Serial data transmission



With the serial data transfer, the digital transmission of the measured data via RS232 / RS485 can be started in ASCII coding. The data is transmitted as a serial digital data stream with a fixed frame consisting of a start bit, five to a maximum of nine data bits, an optional parity bit for detecting transmission errors and a stop bit. This form of data transmission is only available for deltaxwaveC-F.

**Navigation in the User-Interface:**

From the main measurement window "Flow 1": select „SETUP“ → then „COMPL SETUP“ → then „Serial/Modbus/Logger“ → then „Serial Interface Setup“

In this menu window, you can edit or view the basic parameters of the data transmission.

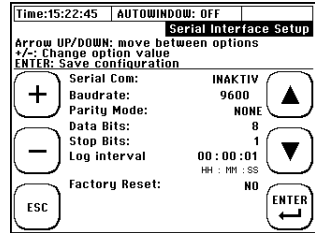

Designation	Reset-Value	Other features
<b>Serial COM:</b> Activation of data transmission	INACTIVE	ACTIVE
<b>Baud rate:</b> Data bits per second	9600	19200, 38400, 56000, 57600, 115200
<b>Parity Mode:</b> Error detection	NONE	ODD, EVEN
<b>Data Bits:</b> Number of data bits.	8	not editable
<b>Stop Bits:</b> Number of stop bits.	1	not editable
<b>Log Interval:</b> Specifies the interval (time) between two consecutive records.	00:00:01	Format: hh:mm:ss hh... hours (00-23) mm...minutes (00-59) ss...seconds (00-59)
<b>Reset:</b> Resets the serial interface to factory settings.	NO	YES

After activation, the following data is transmitted semicolon-separated:

Pos.	Designation	Format	Pos.	Designation	Format
1	Date	JJJJ.MM.TT	7	Heat output	2 DS
2	time stamp	hh:mm:ss	8	Heat quantity	2 DS
3	Flow	2 DS	9	Temperature T1	1 DS
4	Flow rate	2 DS	10	Temperature T2	1 DS
5	Sound speed	2 DS	11	Diff.-Temp. T2-T1	1 DS
6	Totalizer flow	0 DS	12	Signal status	Text
			13	Signal quality	0...100

**i** To test the data transfer you can use the Windows own communication program Hyper terminal. If your PC does not have a serial interface, you can access a commercially available USB to RS232 adapter.

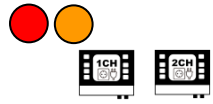

## 11.6.2 Modbus

The deltaxwaveC-F supports the digital transmission of the measured data via Modbus protocol (master / slave architecture). RTU and ASCII Modbus are supported via RS485. This form of data transmission is only available for deltaxwaveC-F.

**From the main measurement window "Flow 1":** select „SETUP“ → then „COMPL SETUP“ → then „Serial/Modbus/Logger“ → then „Modbus Setup“

In this menu window, you can edit or view the basic parameters of the data transmission.

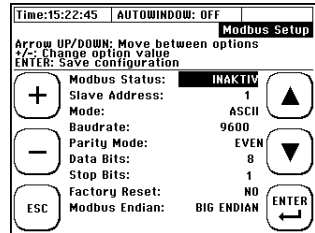

Designation	Reset-Value	Other features
<b>Modbus:</b> Activation of data transmission	INACTIVE	ACTIVE
<b>Slave Address:</b> Of deltaxwaveC-F	1	1... 247
<b>Operating mode:</b>	ASCII	RTU
<b>Baud rate:</b> Data bits per second	9600	19200, 38400, 56000, 57600, 115200
<b>Parity Mode:</b> Error detection	NONE	ODD, EVEN
<b>Data Bits:</b> Number of data bits.	8	not editable
<b>Stop Bits:</b> Number of stop bits.	1	not editable
<b>Reset:</b> Resets the serial interface to factory settings.	NO	YES
<b>Modbus Endian:</b> Byte sequence	BIG ENDIAN	LITTLE ENDIAN



The register overview can be found in the appendix. For additional information, please contact systemc Controls



### 11.6.3 MBus

The deltaxwaveC-F supports the digital transmission of the measured data via MBus via RS485. This form of data transmission is only available for deltaxwaveC-F.

**From the main measurement window "Flow 1":**  
select „SETUP“ → then „COMPL SETUP“ → then „Serial/MBus/Logger“ → then „MBus Setup“

In this menu window, you can edit or view the basic parameters of the data transmission.

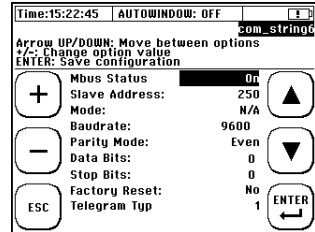

Designation	Reset-Value	Other features
<b>MBus Status:</b> Activation of data transmission	INACTIVE	ACTIVE
<b>Slave Address:</b> Of deltaxwaveC-F	1	1... 247
<b>Operating mode:</b>	N/A	N/A
<b>Baud rate:</b> Data bits per second	9600	300, 600, 1200, 2400, 4800, 19200, 38400
<b>Parity Mode:</b> Error detection	NONE	ODD, EVEN
<b>Data Bits:</b> Number of data bits.	8	not editable
<b>Stop Bits:</b> Number of stop bits.	1	not editable
<b>Reset:</b> Resets the serial interface to factory settings.	NO	YES
<b>Telegram Type:</b> Differs between the water meter (type 1) and heat meter (type 2)	1	2



## 11.6.4 The Data Logger

Logging of data is the time-controlled recording (storage) of measured value data on the device internal memory.



With the deltaxwaveC-P, the data logger is freely available and included as standard.



With deltaxwaveC-F the data logger can be ordered as an option. When ordering without data logger, this is included in the firmware (locked) and can be subsequently activated if required (subject to a charge).

Please contact us if you are interested in a vacancy.



### 11.6.4.1 Activation of the data logger:



The activation of the data logger is bound to a password. If you want to activate a data logger that is not activated ex works, please proceed as follows:

- 1) In the main menu navigate to sub menu "6 Serial/Modbus/Logger".
- 2) As soon as you select the sub-menu item 3 "Data logger", you will be forwarded to a password query. At the same time, a random code is generated and stored on the SD card in the file "Passwort.txt". If you do not have the activation code, cancel the activation process ("ESC").

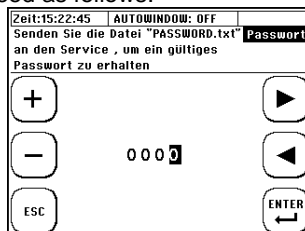

- 3) Connect the transmitter to a PC via USB (USB 2.0: Type A plug to Mini B plug). The USB connection is located in the cable compartment and can be accessed by removing the housing cover above the cable compartment. Having connected deltaxwaveC-F to your computer, the device will be recognized as mass storage device.
- 4) The SD card inside the unit is recognised as a mass storage device. Now copy the file "Passwort.txt" from the deltaxwaveC-F to your PC.
- 5) Please send the file password.txt to systemec or open the file password.txt with a text editor and send the twelve-digit code to systemec.
- 6) Subsequently you will receive a four-digit code for the activation which you enter as a password. Afterwards, the data logger function is permanently activated, even if you install a new firmware version on your measuring system.

### 11.6.4.2 Administration and structure of log data





The current hardware state (4GB SD memory) allows the recording of data up to one year when recording in a secondary interval (with a 10 s interval 10 years). For longer recording periods, the memory can be expanded. The deltaxwaveC supports SD memory up to 32 GB.

The speed of the USB data transmission is limited by the maintenance of the measurement performance and is correspondingly slow. When exporting large amounts of data, the recommendation is to remove the SD card and to exchange the data directly via the corresponding slot on the PC.

Deleting log files can only be done via the USB connection to the PC. We recommend copying the data to an external storage medium before editing or visualizing data.

In the event of a power failure (for example, an empty battery at deltaxwaveC-P), the data is not lost. As soon as the device is powered up again, the data recording continues automatically (except the predefined duration of data recording has already been exceeded).

#### Structure of the Log-File

Format	"*.csv"; Text separated by semicolon Processing by text editors or spreadsheet programs (e.g., Microsoft Excel)
Headlines	Details of time control Relevant details of the parameterization
Measurement data 	Date, time, volume flow, flow rate, sound velocity, volume totalizer, heat output, heat dissipation titter, T1 [° C], T2 [° C], T2-T1 [° C], mass flow, totalizer mass, battery status, signal quality, status
Measurement data 	Date, time, volume flow CH1, volume flow CH2, flow rate CH1, flow rate CH2, sound velocity CH1, sound velocity CH2, volume totalizer CH1, volume totalizer CH2, Average heat output (CH1+Ch2), Average heat quantity totaliser (CH1+CH2), , T1 [° C], T2 [° C], T2-T1 [° C], Average mass flow (CH1+CH2), Average total mass (CH1+CH2), signal quality CH1, status CH1, signal quality CH2, statusCH2



In addition to the above-mentioned measurement data, the value of the two analogue inputs is output with deltaxwaveC-F, provided these have been parameterised.

The measured values between two recording intervals are not averaged. The current measurement value is always recorded at the respective time. Detailed instructions for the transformation from a \*.csv file to a \*.xls (x) can be found on the USB stick under the service instructions.

### 11.6.4.3 Starting a time-controlled data record



From the main measurement window "Flow 1":  
select „SETUP“ → then „COMPL SETUP“ → then  
„Serial/Modbus/Logger“ → then choose



„Data Logger“



„Serial/Modbus/Logger“ → „Data Logger“

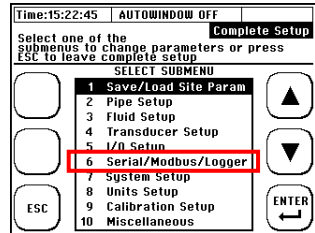

#### Edit the file name:

- Use the arrow keys to select characters corresponding to the PAR file name (**up to 5 characters**).
- Press "ENTER" to confirm the selection of a character.
- Press "DEL" to clear the last character.
- Exit by navigating to "ESC" and confirming with "ENTER"

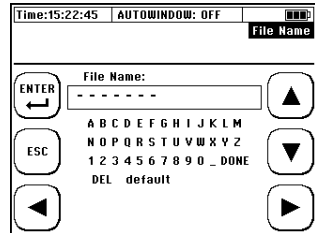

The name you have chosen (e.g. "12ABC") is provided with a 3-digit number (initial filename: "12ABC000.txt"). A maximum of 65536 lines are written per file. Then a new file is created and the number is incremented by one ("12ABC001.txt").

#### Edit the time control

- Use the arrow keys to navigate
- Change the values with the (+) and (-) buttons
- Press "ENTER" to confirm the edited values
- With "ESC" return to the editing of the file name

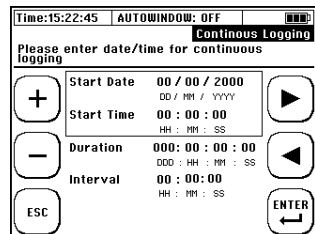

**Example:** It should every 60 seconds record data's between 25.05.2012, 3 pm and 26.05.2012, 14 pm is.



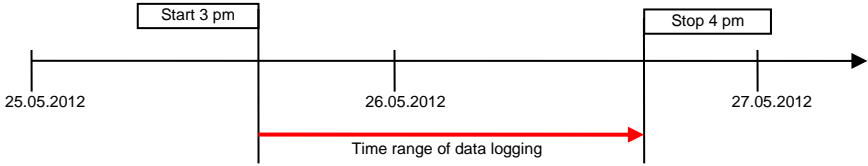

1. Enter 25.05.2012 as start date
2. Enter the start time at 3 pm
3. Enter 001: 01: 00: 00 as the duration
4. Enter the interval 00:01:00



Note that the timer recording is coupled to the system time of deltaxwaveC-F/P. If the system time or the system date is not set correctly, this directly affects your parameterized data recording!  
The **beginning of the data logging should always be in the future** in relation to the current system time of deltaxwaveC-F/P. Otherwise, the data logging will not start.

### 11.6.4.4 Cancelling a time-controlled data record



If the logger is active and records data according to the parameterization, this is indicated in the header line: "LOGGER ON". With the deltaxwaveC-F, serial communication and Modbus have priority and can block the display.

If you plan to stop the scheduled recording, please navigate as follows:

**From the main measurement window "Flow 1":** select „SETUP“ → then „COMPL SETUP“ → then „Serial/Modbus/Logger“ → then choose

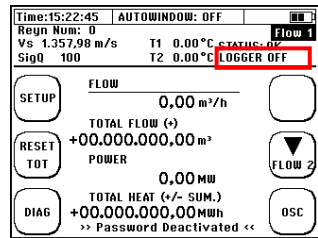

„Data Logger“



„Serial/Modbus/Logger“ → “Data Logger“

To cancel the data recording, press "Yes"

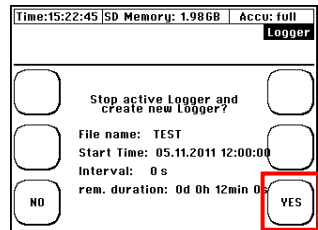

If the recording is terminated prematurely, the data recorded until then are retained on the SD card. Data is recorded up to the time of the exit.



### 11.6.4.5 Quick-Logger

The Quick-Logger function is only available for deltaxwaveC-P.

It allows a quick start of the data recording with standard settings:

The predefined file name oriented is made up of the current system time and the number appendix (Z): "hhmmsZZ.txt"

(E.g. For 14:59:24 hrs: "14592000.txt")

**Duration:** endless

**Interval:** 10s

**Activation:** Press the "QUICK LOG" button for 3-4 seconds

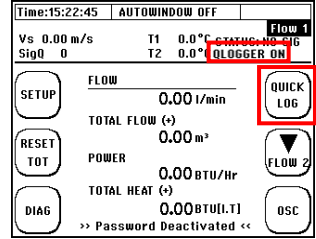

 Press and hold the button for several seconds to prevent accidental starting. If the Quick Logger is active, "QLOGGER ON" is displayed in the communication status.

### 11.6.4.6 WakeUp-Logger



The WakeUp-Logger function enables the deltaxwaveC-P to record measured values for a measurement interval whose start time is in the longer future (longer than the regular battery life) in battery mode. The parameterisation is done analogue to 11.6.4.3. **Fehler! Verweisquelle konnte nicht gefunden werden..**

After parameterisation, the deltaxwaveC-P is put into an energy-saving sleep mode and cannot be used during this time. At the set time, the unit starts automatically and begins the set recording. After the end of the parameterised recording interval, the unit remains active and can be used normally.



 When the set start time is reached, the unit is started. It takes approx. 15 seconds to do this. Subsequently, an average of the measured values is collected over the damping period set under 11.10.1. Only after this period has elapsed can the logged values be considered valid. Therefore, when parameterising your start time, observe a lead time that matches your settings if you want to record valid measured values at a certain time.

### 11.6.4.7 Energy saving mode

The energy-saving mode allows the deltaxwaveC-P to be used in battery mode for measurements over long periods of time with large measurement intervals that extend beyond the normal operating time. For this purpose, a sleep time and a wake time is parameterised.

During sleep time, the unit is put into an energy-saving sleep mode and cannot be used during this time. After the sleep time has elapsed, the device is started for the waking time and begins the measurement. An average value of the flow rate over the wake time is formed and stored. The unit is then put back into sleep mode.

The data log runs from its start with a sleep time until it is manually stopped or the battery is empty.

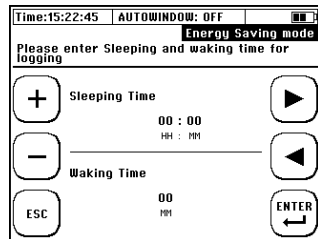
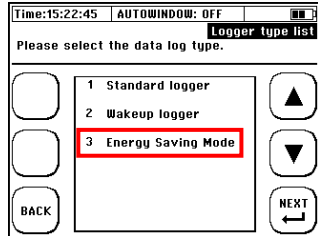

### 11.7 Systems Settings



#### Navigation in the User-Interface:

From the main measurement window "Flow 1": select „SETUP“ → then „COMPL SETUP“ → then „System Setup“

The available submenus are shown on the right.

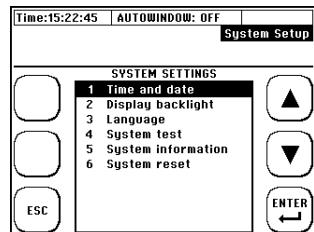

### 11.7.1 Editing the time and date

#### Navigation in the User-Interface:

From the main measurement window "Flow 1":  
select „SETUP“ → then „COMPL SETUP“ → then  
„System Setup “→ „Time and date“

- ▶◀: Navigation / Selection
- +/-: Change of value
- ESC/ENTER: Cancel / Confirm

Enter the current time (hh:mm:ss) and date (DD/MM /YY) and confirm.

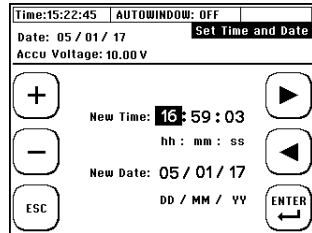

### 11.7.2 Changing the indicator light

#### Navigation in the User-Interface:

From the main measurement window "Flow 1":  
select „SETUP“ → then „COMPL SETUP“ → then  
„System Setup “→ „Display backlight“

- +/-: Change of value
- ESC/ENTER: Cancel / Confirm

Set the display brightness and confirm.

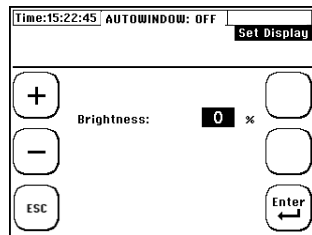

### 11.7.3 Changing the menu language

#### Navigation in the User-Interface:

From the main measurement window "Flow 1":  
select „SETUP“ → then „COMPL SETUP“ → then  
„System Setup “→ „Language“

▲▼: Navigation / Selection  
ESC/ENTER: Cancel / Confirm

Select a language and confirm.

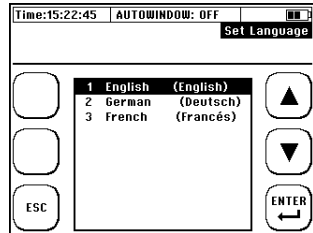

Use the language setting to change the language in the menus. The language of the multifunction keys remains largely unchanged.

### 11.7.4 System test

#### Navigation in the User-Interface:

From the main measurement window "Flow 1":  
select „SETUP“ → then „COMPL SETUP“ → then  
„System Setup “→ „System test“

▲▼: Navigation /Selection  
ESC/ENTER: Cancel / Change of function  
MUS: Switch to system test 2

The System Test 1 window allows you to directly test the deltaxwaveC F / P outputs.

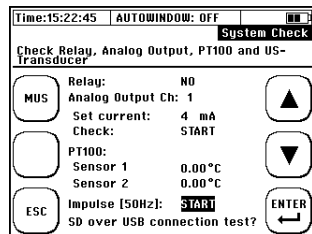

Description	Change with confirmation (ENTER)	Action on activation
Relay	NO/YES	Open/close the relay
Power Activate	Start/Stop	Outputs the parameterized current in mA at the selected analogue output.
Pulse [50 Hz]	Start/Stop	Starts pulse output at 50 Hz.

The System Test 2 window allows you to indirectly test the deltaxwaveC-F/P outputs by specifying a flow rate. Parameterize a measuring point and simulate a flow:

▲▼: Navigation / Selection  
+/-: Change of value  
ESC/ENTER: Cancel / Confirm

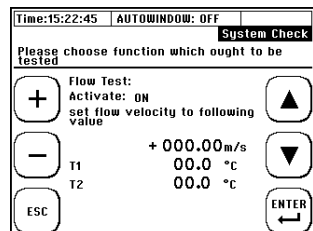

### 11.7.5 System information

#### Navigation in the User-Interface:

From the main measurement window "Flow 1":  
select „SETUP“ → then „COMPL SETUP“ → then  
„System Setup “→ „System information“

This window can be used to check the system's hardware and software.

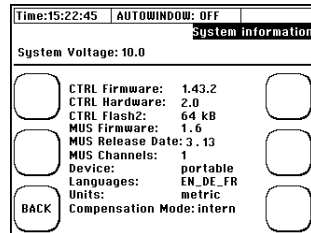

CTRL Firmware	Firmware version of the user interface (CTRL Board)
CTRL Hardware	Hardware version (CTRL Board)
CTRL Flash2	Size of the Flash Memory 2 (CTRL Board)
MUS Firmware	Firmware version of the MUS Board
MUS Release Date	Release date of the MUS firmware
MUS Channels	Number of MUS channels: 1, 2
Device	portable, fix
Languages:	Integrated voice pack of the CTRL firmware
Units	unit system
Compensation Mode	Internal, external (integrated compensation)

### 11.7.6 System Reset

From the main measurement window "Flow 1":  
select „SETUP“ → then „COMPL SETUP“ → then  
„System Setup “→ „System reset“

The system reset function resets all parameters to factory settings. If you receive a device with unknown history or if the device shows malfunctions, it is possibility to overwrite invalid settings.

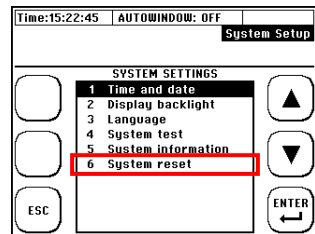

All settings are overwritten by a system reset, both the parameterization of the measuring point, as well as the totalizer. The set date and time are not affected.

## 11.8 Unit selection



### Navigation in the User-Interface:

**From the main measurement window "Flow 1":** select „SETUP“ → then „COMPL SETUP“ → “Units Setup”

Choose the variable of which you want to change the unit!

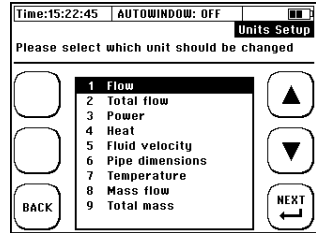

Physical size	Units supported by delatwaveC-F/P
Flow	m <sup>3</sup> /s; m <sup>3</sup> /min; m <sup>3</sup> /h; l/s; l/min; l/h; gal/s (Imp.gal.); gal/min (Imp.gal.); gal/h (Imp.gal.); ft <sup>3</sup> /s; ft <sup>3</sup> /min; ft <sup>3</sup> /h; gal/s (US.liq.gal.); gal/min (US.liq.gal.); gal/h (US.liq.gal.)
Total Flow	m <sup>3</sup> ; l; gal (Imp.gal.); ft <sup>3</sup> ; ml; gal (US.liq.gal.)
Power	MW; kW; W; BTU/Hr; J/Hr
Heat	MWh; kWh; Wh; BTU/Hr(i.t); J
Fluid velocity	m/s; ft/s
Pipe dimensions	mm; inch
Temperature	°C; °F
Mass flow	kg/s; kg/min; kg/h; t/s; t/min; t/h
Total mass	kg; t

## 11.9 Calibration



From the main measurement window "Flow 1":  
select „SETUP“ → then „COMPL SETUP“ →  
„Calibration “

Select the desired calibration option from the  
calibration menu.

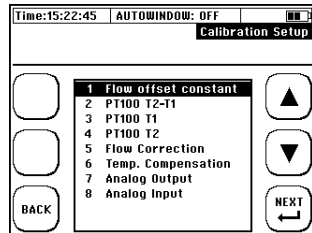

### 11.9.1 Flow-Offset

Select in the calibration menu „Flow offset  
constant“.

Enter the desired offset correction  
(Attention: Span correction).

Check the flow at 2-3 relevant flow rates to check  
whether the percentage correction is permissible.  
The offset remains stored in the device until it is  
overwritten by a new value.

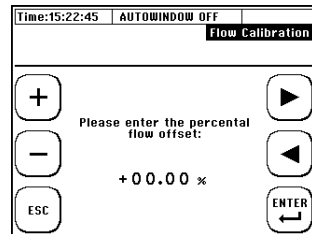

### 11.9.2 Matching the Pt100

Select in calibration „PT100 T2-T1“

„Read OFFSET“:

Automatic calculation of the offset (T2-T1)

„RESET OFFSET“:

Resets the current offset to zero.

"YES": Confirmation of the calculated offset

"NO": Abort.

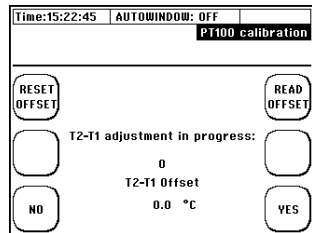

### 11.9.3 Pt100 Offset

In the calibration menu, select "PT100 T1 / T2".

Now enter the actual temperature for T1 / T2  
(default value). Attention! The default value is an  
absolute temperature and no offset with respect to  
the displayed temperature, press "RESET" to clear  
the default value. The Pt100 shows again the  
temperature without correction.

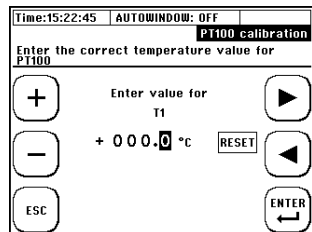



### 11.9.4 Parameterization of a flow velocity characteristic

In the "Flow Correction" submenu of the calibration menu, you can view the points of a configurable characteristic. Between the individual points is linearly interpolated.

Characteristics can only be created for individual measuring points and enable accurate measurements even beyond the recommended inlet and outlet distances.

- Delete ALL: Set all points to zero
- Delete: Set a single point to zero
- ▲▼: Navigation / Selection
- Next: In the window for editing the points

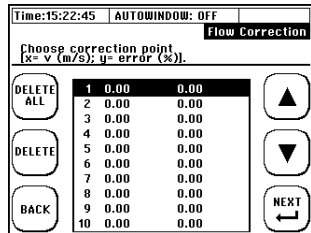

After a point has been selected, the flow velocity (in m / s) and the corresponding correction value (in%) can be entered.

Example: At +0.15 m/s a deviation of + 0.8% was determined. The corresponding correction point is (+0.15; -0.8)

- ▶◀: Navigation / Selection
- +/-: Changing value
- ESC: Return to overview
- ENTER: Confirm of the edited values

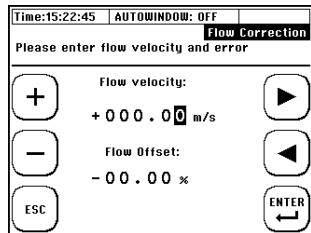

As soon as a point pair [x=v(m/s); Y=correction(%)] was confirmed, the correction is valid and the interpolation coefficients are internally recalculated.

For details on the input rules and other behaviour of multipoint calibration, please have a look at the service manual.

### 11.9.5 Temperature compensation

Select "**Temp. compensation**" in the calibration menu. You now have the choice of manual input or using the PT100 values T1 and T2.

For manual input, enter the compensation temperature.

With this function, the unit takes into account the temperature-dependent change in density, specific heat capacity and kinematic viscosity to calculate the flow rate, mass flow and heat quantity.

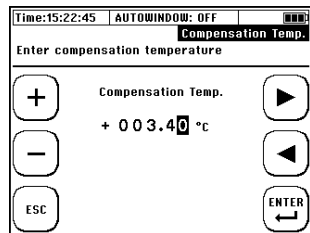

## 11.9.6 Calibration of analogue outputs

The calibration of the analogue outputs is based on a 2-point calibration.

### Procedure:

- 1) Before coefficients for the correction of the analogue outputs can be calculated, it is necessary to measure the current currents for the present values 4 and 20 mA at the respective outputs with an admissible current measuring device. Use the **System test 1** window. (see 11.7.4).
- 2) Now change to the calibration menu and select "**Analog output**".
- 3) Select the analogue output to be calibrated.
- 4) Enter the **measured reference** value for **4 mA** and confirm.
- 5) Enter the **measured reference** value for **20 mA** and confirm.

The correction coefficients are now calculated automatically and stored in the system.

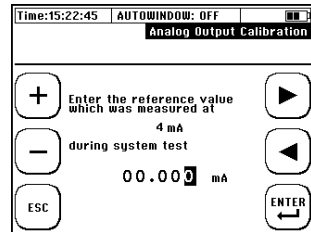
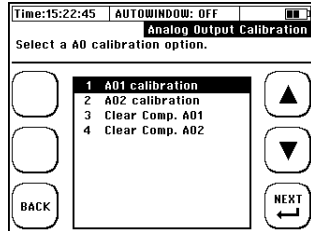

## 11.10 Miscellaneous Parameters



### Navigation in the User-Interface:

From the main measurement window "Flow 1":  
select „SETUP“ → then „COMPL SETUP“ → „Miscellaneous “

The following options are available:

1	Damping Flow
2	Damping PT100
3	Cutoff Flow
4	Zero
5	Totalizer flow
6	Totalizer heat

7	Totalizer mass
8	Sensor distance
9	Pipe roughness
10	Sensor test
11	Signal optimization

### 11.10.1 Damping & Burnout

Select in the menu Miscellaneous "Damping flow"  
or "Damping Pt100"

The editing of the **burnout** parameter is only possible for the flow parameter and can be found in the "Damping flow" menu item.

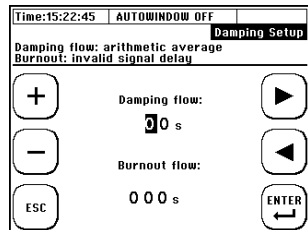

#### Damping flow rate / Pt100:

Here you have the possibility to damp the signal output (temporal length of the mean value filter). The larger the damping, the slower delatwaveC-F/P reacts to changes changing values. Typical attenuations range from 5-60 seconds.

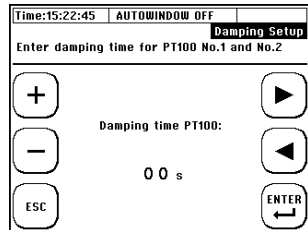

#### Burnout FLOW:

Low signal quality (SigQ <50, headline top left) causes the measurement to be invalid and the measured values fall to zero. With the help of the burnout function, the last valid measured value (SigQ > 50) can be retained for the parameterized duration (= burnout).



This function can be used to eliminate temporary disturbances (for example short-term gas input or temporary disturbances of the flow profile). In practice, the use of this function is recommended for strongly fluctuating SigQ values / flow measurement values.

### 11.10.2 Cut off Flow

Select in the menu Miscellaneous "Cut off Flow"

Absolute flow velocities smaller than the edited flow threshold will be not considered (zero set).

Flow values which depending from the flow (flow rate, heat quantity, and so on) are also affected by this parameterization.

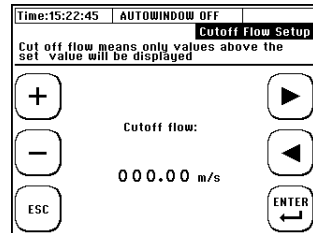

### 11.10.3 Zero

Select in the menu Miscellaneous "Zero"

Here you can set the zero point (see chapter 8.6), delete and enter (manually edit based on documented values).

The zero point remains stored in the device until it has been automatically overwritten by a new zero offset or has been manually removed by "Delete zero".

The zero point is automatically deleted if relevant parameters (pipe, medium, transducer, frequency or signal coding) are edited again (editing in this sense also includes a renewed confirmation without changing the values). A signal optimisation (with the exception of the zero optimisation) also leads to the deletion of the zero point. **Be careful, when you perform measurements with different application data!**

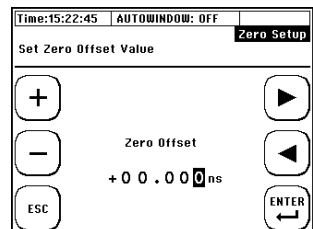
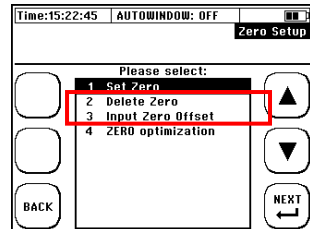

## 11.10.4 The totalizer (counters)

DeltawaveC-F/P has two quantity counters, one quantity counter for volume flow and one quantity counter for heat quantity. Both counters can be parameterized independently of each other in regard to their way of counting. The **parameterization of the totalizers** allows implementation of various applications considering the bidirectional flow rate. It is, for example, possible to consider only volume flows in a flow direction (positive or negative counter).

Particularly when parameterizing the heat quantity totalizers, pay attention the effects of the signs have to be pay attended:

- (+) Volume flow x (+) Temperature difference = (+) Heat output,
- (-) Volume flow x (-) Temperature difference = (+) Heat output,
- (-) Volume flow x (+) Temperature difference = (-) Heat output.



The pulse output of the transmitter behaves in line with the parameterization of the counting method of the respective counter.

### Parameterization of the totalizers

Type of Counter	Example
<b>1. Positive-Counter (+):</b> Volumes with a positive flow direction are summed up.	A flow of 30 litres in the direction of flow and 10 litres. In summary 30 pulses will be given out.
<b>2. Negative-Counter (-):</b> Volumes with negative flow direction are added up.	A flow of 30 litres in the direction of flow and 10 litres. In summary 10 pulses will be given out.
<b>3. Amount- Counter (+/- Sum.):</b> The amount of all volumes is added up.	A flow of 30 litres in the direction of flow and 10 litres. In summary 40 pulses will be given out.
<b>4. Different- Counter (+/- Diff.):</b> It is the sum formed from all volumes (considering the sign)	A flow of 30 litres in the direction of flow and 10 litres. In summary 20 pulses will be given out.

#### Navigation in the User-Interface:

From the main measurement window "Flow 1": select „SETUP“ → then „COMPL SETUP“ → „Miscellaneous“ → Select now „Totalizer Flow“ or „ Totalizer heat“.

Now, parameterize the pulse output according to the requirements of the application as described above.

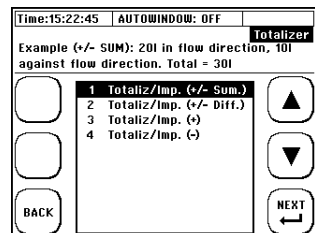

### 11.10.5 Pipe roughness

Select "Pipe roughness" in the Miscellaneous menu.

Here you can set the effective roughness of the inner surface of the pipe.

With this function, the surface roughness on the inside of the pipe is taken into account as a correction factor when determining the Reynolds compensation.

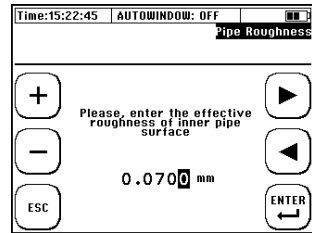

### 11.10.6 Sensor test

The deltaxwaveC-F/P offers you the possibility to test the ultrasonic transducers together with the signal cables. If, for example, the current measurement does not produce a result, a sensor test can be used to ensure that the ultrasonic transducers function correctly together with the signal cable. In this way, the error can be narrowed down to the application. Proceed as follows:

Make sure that the ultrasonic transducers are connected and the correct transducer type (COMPL SETUP → Transducer Setup) is parameterised.

Select "Sensor test" in the Miscellaneous menu.

You now have the choice of performing the sensor test in Z-mode directly between two transducers, or in V-mode on a steel or PVC block.

Select the desired mode. The following description refers to the sensor test in Z mode.

**After selecting the mode, you will be directed to the oscilloscope window:**

- 1) Spread some acoustic coupling medium on one of the two transducers and position the ultrasonic transducers in relation to each other as shown on the right so that approx. 2/3 of the acoustic transmission area overlaps (Z-mode without tube).

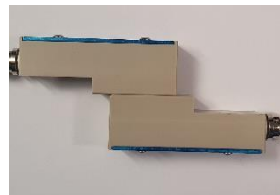

- 2) If the ultrasonic transducers are functioning properly, the signal cables are undamaged and correctly connected, then from the beginning of the time window there is first an area without a signal (zero line), then a clear received signal (several signal packets with great similarity on both signal paths), possibly a swing-out behaviour and then a zero line again. As the deltaxwaveC allows the setting of a large combination of size of the time window, transmission coding and transducer frequency, the exact position, as well as the expression of the signal depends on the individual settings of your device (for examples, see the following illustrations). However, it always remains with the mentioned sequence of the areas zero line, received signal, zero line.

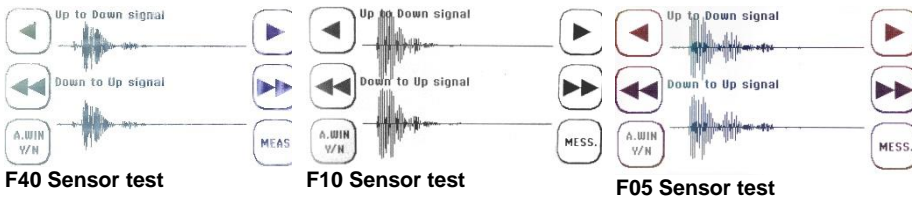

- 3) In contrast, in the case of defective ultrasonic transducers or signal cables, ONLY the relics of the transmitted signals can be seen immediately from the start of the measurement window. The signal characteristics range between Figure 23 and Figure 24. Transmitted signal relics can also appear with correctly functioning transducers, but are then small compared to the useful signals.

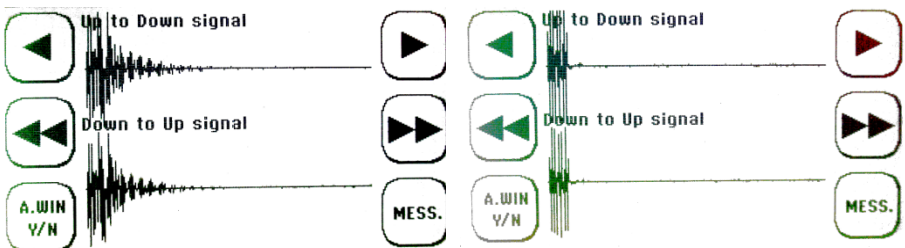

Figure 23: Transducer connected, no acoustic contact (without Magnalube)

Figure 24: Transducer not connected (relics of the transmitted signals)

## 12 Additional information about the hardware

### 12.1 Hardware and Software Reset



The deltaxwaveC-F/P distinguishes between two types of reset: hardware and software reset. The data on the device-internal SD card remain unaffected by a reset.

#### 1. The Hardware Reset:

The hardware reset is an ON / OFF reset. The device is rebooted, and passes through a full initialization. The data and parameters in the internal flash memory are retained.

The hardware reset is used when the device is no longer responding (system time is stopped, no keyboard input is possible, and so on).

Section of deltaxwaveC-F Connector-board



Remove the cover over the cable compartment and press the Reset button shown above.

Section of deltaxwaveC-P backside

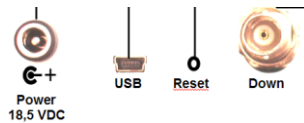

Use a pointed object to press the button located behind the opening on the back of the device.

#### 2. The Software Reset

##### Triggering a "Software Reset":

1. **Immediately on the start:** "RESET SYS."
2. **From the main measurement window "Flow 1":** select „SETUP“ → then „COMPL SETUP“ → „System Setup“ → „System reset“

In the case of a software reset, all values in the flash memory and in the RAM memory of the deltaxwaveC-F/P will be set to zero. The system is then reinitialized with the factory settings.

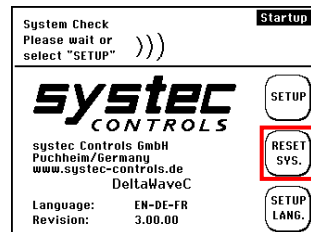

The software reset is applied when no or non-plausible values are displayed in display fields.  
All parameters are reset (totalizer values, pipe parameters, etc.); Load a pre-stored parameter file or re-parameterize the transmitter.



## 12.2 Data export and import



If the transmitter is connected via USB to a PC (see chapter 5), the SD card is recognized as an external data storage device on Windows and MAC OS and data can be exchanged.



The speed of the USB data transmission is limited by the maintenance of the measurement performance and is correspondingly slow.

Tip: For optimal data exchange it is advisable to deactivate any digital data record (serial communication, Modbus, MBUS, Logger).

When exporting large amounts of data, it is recommended to remove the SD card and to exchange the data directly via the corresponding slot on the PC.

Deleting log files can only be done via the USB connection to the PC. We recommend copying the data to an external storage medium before editing or visualizing data.

In the event of a power failure (for example, an empty battery at delatwaveC-P), the data's are not lost. As soon as the device is powered up again, the data recording continues automatically (except the predefined duration of data recording has already been exceeded).



For mass storage > 2GB the detection can take some time. Please wait a minute.



### 13 Pulse outputs active/passive

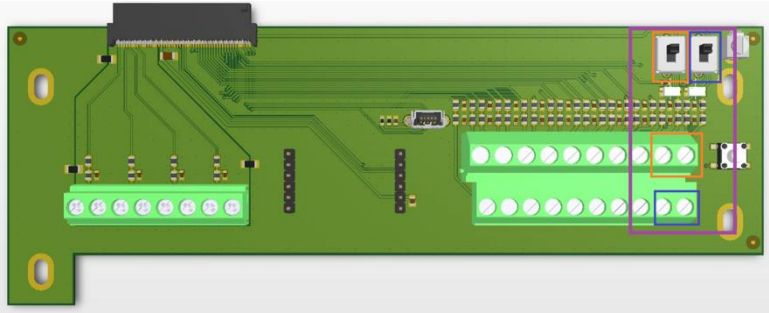

There are now only switches IMP1 and IMP2 (pictures of the new CON2 have already been sent), with which the supply is configured:

- ON = activ = Vsupply: 12V internal = not potential free
- OFF = passive = Vsupply: external = potential free

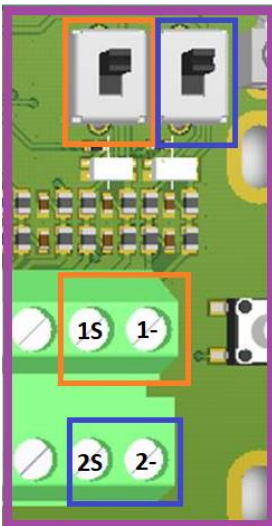

The pulse output is designed as a transistor output (open collector) and is always passive with deltaxwaveC-P (external supply: 3...12V/DC).

With the deltaxwaveC, the output form of the pulse is parameterized via the user interface.

The following measured variables can be assigned to the pulse output:

- flow (total volume)
- amount of heat
- total mass

Possible pulse lengths: 20, 40, 60, 100, 260, 500 ms

The 2-channel version has a second pulse output g, so that the totalizers can be assigned separately according to measurement paths (1CH, 2CH).

### 13.1 RS232 / RS485 Interfaces

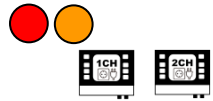

The firmware on your deltaxwaveC-F is already equipped with all necessary functions for data output of the measured values via an RS232 / RS485 interface. Each deltaxwaveC-F can be retrofitted with a serial interface card (option).

RS232 interfaces allow cable lengths up to approx. 20 m between deltaxwaveC-F and evaluation unit. RS485 interfaces allow cable lengths up to several 100 m between deltaxwaveC-F and evaluation unit. Additionally, a Modbus or MBus communication can be realized via the RS485 interface card.

**i** The Modbus or MBus functionality of deltaxwaveC-F via RS485 interface is not discussed in this manual. For additional information, please contact systemc Controls.

RS232 interface board:

The ModBus interface board is configurable for 2-wire or 4-wire communication mode (Jumper).

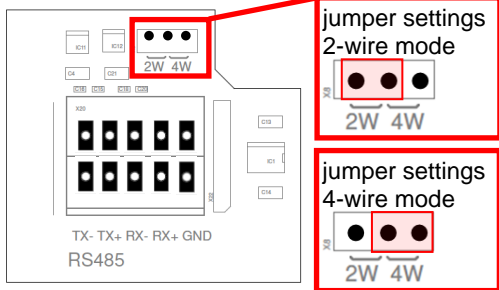
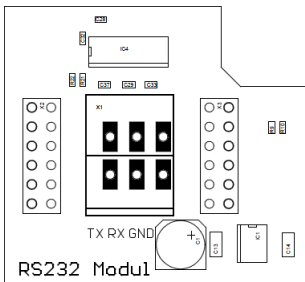

**Subsequent installation:**

Disconnect your deltaxwaveC-F from the power supply. Just put the serial interface board on the two free socket boards, that's it.

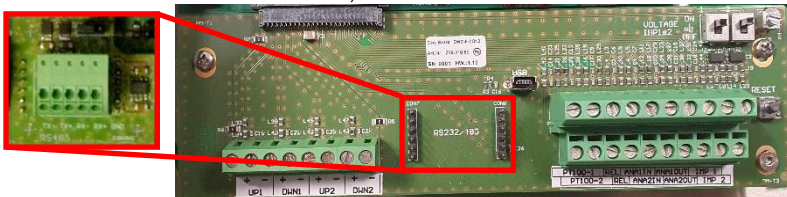

**Connecting the serial interface board with a receiver (e.g. a PC) exemplary shown in case of a RS232 interface board:**

To establish a connection between delatwaveC-F and a PC, please produce a connection cable with the following plugs in case of a RS232 interface board:

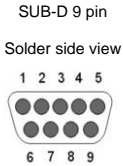

Designation		Pin 9 Pol. Sub D
TX	Transmit Data	3
RX	Receive Data	2
GND	Ground	5



Several participants or the bridging of longer distances with the corresponding load with interfering signals may require the application of an appropriate termination.



## 14 Tips and Tricks

### 14.1 Measuring mixed fluids

If liquids are present as a mixture, then in a first step it is necessary to know the mixing ratio.

To draw conclusions on the actual values of a liquid mixture

The application of complex calculation models is normally required. In practice, the approach described below helps to achieve a reliable measurement result in pragmatic terms in most cases.

The following is an example of the mixture: 10% glycol; 90% water (20 ° C). To configure the fluid mixture, proceed as follows:

## A.) Material data

The substance data of the individual components are required. Material data for relevant media are stored in the deltaxwaveC-F / P database and can be found in the parameter overview or the substance data tables in the appendix of this manual. The following data are required for the correct determination of the flow velocity:

- Sound velocity
- Kinematic viscosity

The following data are also required for the correct determination of the heat quantity:

- Heat capacity
- Density of the medium

For the above example, the following material data are obtained for 20°C.:

	<b>Water 100%</b>	<b>Glycol 100%</b>
Vs [m/s]	1486	1666
Kinematic Viscosity [E-6 m <sup>2</sup> /s]	1,003	21,11
Density [kg/m <sup>3</sup> ]	998,20	1110,00
heat capacity [kJ/kgK]	4,182	2,400

## B) Linear approximation

Multiply the respective component fraction (mass fraction, volume fraction material fraction) with the component property, and add both.

$$V_s(\text{mixture}) = \sum(V_{s\text{Components}} * \text{Quantity}_{\text{Components}})$$

$$V_s(\text{mixture}) = (1486 \text{ m/s} * 0,9) + (1666\text{m/s} * 0,1)$$

$$V_s(\text{mixture}) = 1504 \text{ m/s}$$

According to the example, the following material data are obtained for the mixture at 20°C:

	<b>Water 90%, Glycol 10%</b>
Vs [m/s]	1504
Kinematic Viscosity [E-6 m <sup>2</sup> /s]	3,0137
Density [kg/m <sup>3</sup> ]	1009,38
heat capacity [kJ/kgK]	4,0038

## C) Parameterization of the medium

Afterwards please navigate from the main menu again to the menu option "Parameter medium". Select users input now and enter the values you have calculated as user-defined values.



If the characteristics of the specific substance are not in the manual or the database of the device, data sheets of the producer of the fluid can give you information on its parameters.

Also useful in the search for substance data are specialized search engines (<http://www.wolframalpha.com/>).

As the parameter viscosity of a fluid is very often not given. In this case, the value of density and dynamic viscosity can be calculated. Be sure to enter the values on the units.

Helpful converter: <http://www.cactus2000.de/de/unit/massvik.php>

### 14.2 Measuring unknown fluids

In practical applications it is quite possible that there is no information regarding sound velocity (or other material data) or composition for a specific fluid. As an example, the food industry (various beverages, for example apple juice) is mentioned here.

In order to determine the flow rate in the tube and thus the volume flow in the tube, the sound velocity of the medium is primarily important. The kinematic viscosity is necessary for correct Reynolds compensation (see chapter 4). The density and heat capacity are only important for the determination of heat output or heat quantity. To stay with our example: In the case of apple juice it is rarely necessary to carry out a heat quantity measurement.

Furthermore, it is sufficient for watery solutions to assume the values of water in a first approximation. For hydrocarbons, the values of oil or gasoline, depending on the application.

Example: You do not know the exact composition of your medium, but you can assume that it is an aqueous solution.

Proceed as follows:

1. Parameterize your deltaxwaveC-F/P according to the application (quick setup, pipe dimensions, and so on).
2. As soon as you select the liquid, select the medium which is the most similar to the medium to be measured from the deltaxwaveC-F / P database. In this case water (20 ° C).
3. Now install the ultrasonic transducers according to the sensor distance output.

- Now change to the measurement window 1. The sound velocity of the medium is displayed at the top left.
- Now run the Quick setup again. When selecting the medium, select user input and edit the sound velocity according to the value displayed in measurement window 1 (leave all other values).

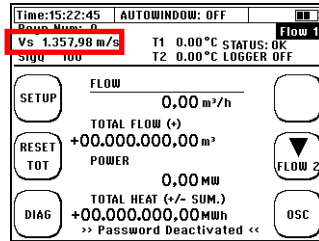

- Complete the Quick setup now. In the setup window, you will now see a sensor distance corresponding to the parameterization.
- If a different sensor distance is recommended, change the installation of the ultrasonic transducers accordingly.
- Start again from point 4. Repeat the procedure until the sensor distance output from deltaxwaveC-F / P no longer changes.



In rare cases it might happen, that the measuring inaccuracy is not satisfactory even if you have followed the procedure above.

In this case, we recommend compensation using an offset correction. Reset the Totalizer value ("RESET TOT"), start the flow and catch the flow of the fluid in a container. Determine the volume (directly or via mass determination and density) and compare the value with the deltaxwaveC-F/P display.

Now parameterize the corresponding compensation value:

From the measuring window 1 outgoing → Complete setup → Calibration → Flow offset. Now enter the percentage of deviance between the reference quantity and the measured quantity.

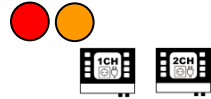

## 15 Troubleshooting

You have parameterized a measuring point, the ultrasonic transducers are mounted and do not get any plausible results or the flow zero. Or you can get meaningful results in the display of the deltaxwaveC-F/P but have difficulties on transmitting the results analogously or digitally.

This chapter provides a help guidance procedure for successful support:

- A) Checklist:** Use the checklist (see USB stick) for troubleshooting and work through this point by point. If this is not successful, continue with B.



Print out the checklist and work through it step by step. This helps you to keep a cool head in a difficult application and to systematically isolate the error.

**B) Preparation for the support:**

- 1) An extensive evaluation of the device parameterization is essential for successful support. To ensure this, the simplest and safest method is to save the current parameter set (see chapter 11) and export the file (alternatively, you can take pictures of all windows in the parameter overview).
- 2) If you do not receive plausible flow data, an image of the current signal window should also be sent to the support. Navigate to the oscilloscope window and perform an **A-Scan export** (see chapter 15.1). Copy the WAV file via USB (alternatively, you can take a photo of the current signal window).
- 3) In addition, it is possible to take pictures of the ultrasonic transducers installed on the tube. If you are experiencing problems with the analogue or digital signal transmission, you also have a picture of the cable connection space or the wiring.

**C) Contact systemec Controls**

089 / 809 06 0 and [info@systemec-controls.de](mailto:info@systemec-controls.de)

And submit the data to the assigned support (PAR file, WAV file and photos of the transducer installation)



If you do not have the option to send the data electronically (email), please provide the following information: pipe material, pipe diameter, wall thickness, medium, medium temperature, type / length of the inlet sections, sensor type.



## 15.1 The Oscilloscope Window

The oscilloscope (OSC) window can be accessed via the OSC button in the measurement windows or in the diagnostics window.

The OSC window provides the signal analysis, the most powerful diagnostic tool. The currently evaluated signal window is displayed. In particular, the signal shape, the signal sharpness, the signal-to-noise ratio (SNR) and the type of noise are of particular interest.

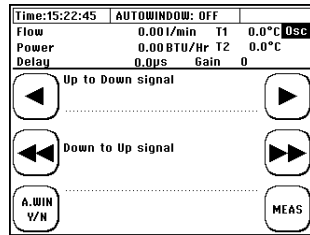

◀/◀◀ Slow / fast decrease of the delay or move to the left on the time axis

▶/▶▶ Slow / fast increase the delay or move to the right on the time axis

**A.WIN**  
**Y/N** Auto window: Turn the function on / off

**MEAS** Return to the measurement window

From the standard header differing display:

Display		Explanation
Values	Flow	Flow rate
	Power	Heat output
	T1 / T2	Temperature values of the Pt100
	Delay	Start value of the displayed signal window in µs
	Gain	Value of the signal gain for the displayed signal

The deltaxwaveC-F/P allows storing current signals (A-Scan) as a WAV file on the SD card. The A-Scan export can only be carried out in the OSC window:

- 1) Press and hold the backlight button for about 5 seconds.
- 2) The OSZ screen freezes and it appears at the bottom of the screen: "A-Scan Export in progress". The A-scan takes approximately 2-3 seconds. After completion, the following appears: "A-Scan Exported to SD-card".
- 3) A corresponding "\*" .wav" file has now been stored on the device-internal SD card. The file name is generated automatically based on the current system time. For the system time (hh: mm: ss) and date (YYYY.MM.TT), the name "TThhmmss.wav" is given.
- 4) Connect your deltaxwaveC-F / P to a PC (USB cable) and copy the desired WAV file.

## 15.2 Signal analysis

The deltaxwaveC-F/P provides powerful diagnostics capabilities that allow the skilled user to make reliable measurements even in difficult applications. The oscilloscope window allows you to quickly assess the quality of your signals. This is especially helpful if you do not get any, or doubtful results. Two signal parameters are particularly important for a good measurement: the signal-to-noise ratio and the signal sharpness.

In order to fully exploit the possibilities of signal analysis, the understanding of wave propagation and signal processing is helpful.

The diagram schematically illustrates various ways that an ultrasonic signal can take in the pipeline.

The refraction and reflection at the phase boundary surfaces is determined by the combination of the material properties.

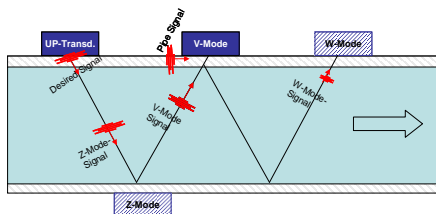

The **UP transducer** (upstream transducer) emits an ultrasonic signal downstream. This signal splits up and is transmitted directly in the pipeline (pipe wall signal) as well as reflected in the medium (Z-mounting signal, V-mounting signal, W-mounting signal).

Depending on the mounting position (Z, V or W mounting) and the signal propagation time, the **DOWN transducer** (downstream transducer) receives the most diverse signals in varying time windows.

After the reception signal is recorded, the transmitter and receiver functions are exchanged and the transmission-reception cycle is repeated. This time, however, the send signal is sent upstream.

The signal propagation time is the time that a signal spends on the signal path associated with it. It depends on the path length and sound velocity in the media being traversed.

After a time “ $t_p$ ” can see the signal that has travelled directly to the pipe wall along.

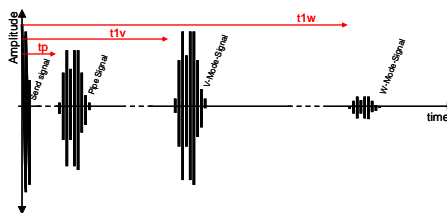

This is usually the first signal on the time axis at the V- or W-position because it has the shortest path length and the sound velocity of the tube wall material is generally higher than that of the liquid. Then, at time  $t_{1v}$ , the V-mount signal comes (simple reflection) and after approximately twice the time,  $t_{1w}$  the W signal (double reflection).

In the case of highly sound conducting piping material (metals) and small pipelines, the piping signal has high amplitude, similar to that of the V-mounting signal. In the case of damping pipeline materials (plastics), the pipe wall signal is often

significantly weaker. The V-mount signal is usually much stronger (higher amplitude) than the W-mount signal. The W signal returns approximately twice the path in the flowing medium. Thus, it is exposed to the signal attenuation phenomena (absorption and scattering) over a longer distance in the medium.

In the case of the Z-mount, a different image is obtained. Here, in addition to the send signal, only the Z signal (at  $t_{1z}$ ) can be seen itself.

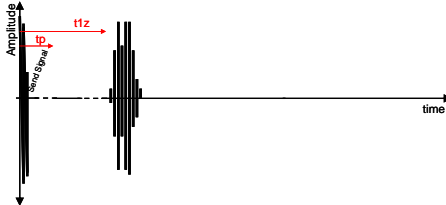

In the oscilloscope window itself, only a small time interval is displayed. The position of this measurement window is defined by the delay. The length is determined by the number of recorded measuring points (no. Of samples) and the measuring rate (fADC).

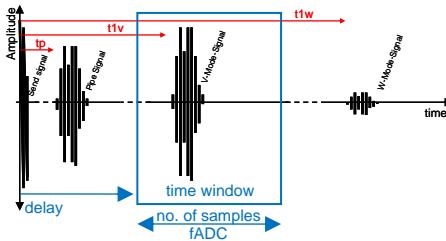

In the oscilloscope window, you usually only see the signal required for the evaluation (for example, the V-mount signal).

### 15.2.1 Signal-to-noise ratio (SNR)

The signal-to-noise ratio (SNR) is an indication of the influence of interference signals on a defined useful signal. The more clearly the signal is detected, the more stable the digital evaluation of the useful signal.

A similarly poor signal-to-noise ratio can be caused by various phenomena:

- 1) A bad acoustic signal (with low noise level)
- 2) A high level of acoustic interfering signals (scattering signal of particles or bubbles)
- 3) A high level of electrical noise (EMC problems)

In any case, an improvement in the signal quality can be achieved either by an improvement in the acoustic useful signal or by avoiding interference signals.

The following is a list of some measures for improving the useful signal quality:

- Surface of pipe: Remove painting or rust
- Coupling grease: Use sufficient coupling grease (Magnalube)
- Alignment of transducers: Make sure that transducers are mounted as suggested by deltaxwaveC-P. Please also make sure that centre of transducers touches the pipe sufficiently (might be problem with very small pipes). You can check the oscilloscope while mounting the transducers.
- Make sure that transducers are not mounted e.g. on welding seams
- Select another pipe position, e.g. A rising pipe (ensuring a fully filled pipe).
- Make sure to provide sufficient straight run
- Minimize the signal path (Z- instead of the V- or V- instead of the W-mount)
- Use a different transducer (lower frequency)

The following is a list of some measures to avoid interfering signals:

- For the deltaxwaveC-F/P, ensure that the shield and core of the transducer cables are connected correctly (see 3.3).
- Check whether your media is sufficiently vented and does not contain too many solids.
- Ensure that the sensor cable is sufficiently far from the power cables.
- Especially keep the pump and frequency inverter apart.

Figure 23 shows a signal with strong noise (unfavourable SNR). A clear noise can be seen on the time axis before and after the signal.

Figure 23b shows signal examples with "good" SNR. On the time axis virtually no more noise can be seen, the signal is ideally on the time axis.

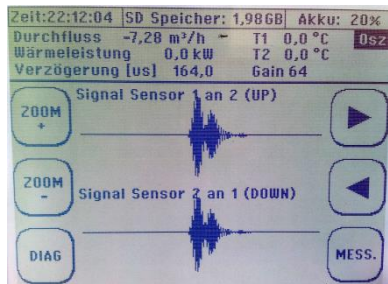
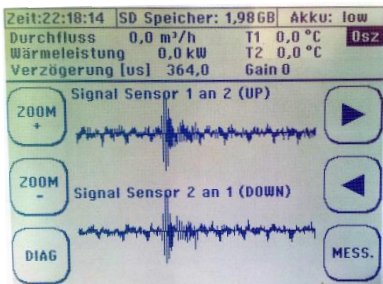

a) b)  
**Figure 23: Sample signals (oscilloscope window) with different SNR**

### 15.2.2 Signal sharpness

The signals from deltaxwaveC-F / P are coded to reliably identify the ultrasonic signals even in the case of very poor signal-to-noise ratios. For this purpose deltaxwaveC-F / P uses phase shifts in the transmit signals. The more clearly these phase shifts can be seen in the receive signal, the more stable your measurement will be under unfavourable measuring conditions. Figure 24a shows a signal with very high signal sharpness

One can clearly recognize approximately 5 oscillations with increasing amplitude and then a reduction amplitude (phase shift) and then again increasing amplitude. The received signal clearly shows the coding of the transmission signal. This is not the case for the signal in Figure 24b. The amplitude increase is initially very small and only after the phase shift does a high amplitude modulation occurs.

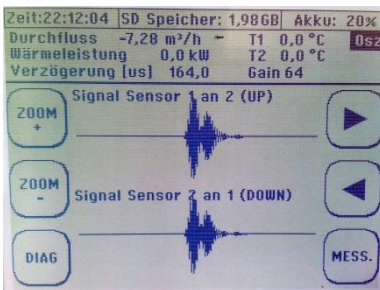

a)

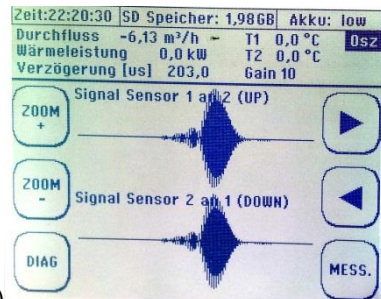

b)

**Figure 24: Sample signals concerning signal sharpness (oscilloscope window)**

In addition to the general measures for improving the useful signal quality (see 15.2.1), the following possibilities for improving the signal sharpness can be checked:

- Select an installation location with another pipe (other material, other dimensions).
- Try other signal encodings (see 15.3)



The highly developed signal evaluation of the deltaxwaveC-F/P also allows for permissible measurement results even with very unfavourable signal sharpness.

Nevertheless, the user should always try to ensure the best possible signal of sharpness, since this reduces the scattering of the measured values in case of additional disturbances.

### 15.2.3 Signal decoupling on small pipelines

In the case of small pipelines (<50mm), the times between the signals are very short or in the worst case the signals can even overlap (with pipe signal, also with W signal). The graphic on the right shows how the different signals can appear in this case.

In the case of signal overlapping, there are various remedial options:

- Use W-Mode rather than V-mode (first counter-measure)
- Use Z-Mode rather than V-mode (when W-mode does not work)
- Disable auto-window function and manual positioning of the measurement window
- Alternative signal coding tests for a narrower / sharper signal ("Barker5" or "Pulse" instead of "Barker7")
- Use a higher frequency transducer to obtain a narrower and sharper signal.

When using a 2 MHz transducer instead of a 1 MHz transducer, the signals are only half as long and therefore easier to unbundle (see right).

For manual positioning, you must always check your settings using the measured medium sound velocity. If this is too high or too low (> 20%), you can assume that you have the wrong signal in the measurement window (for example V signal instead of W signal or vice versa).

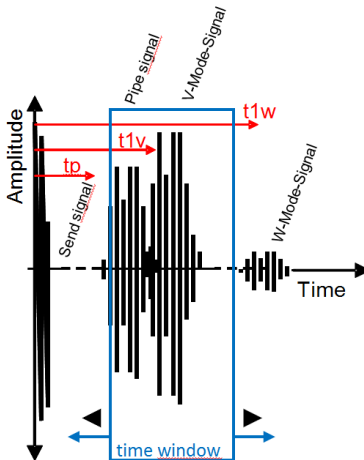

Figure 25: Signal superimposition for small pipelines

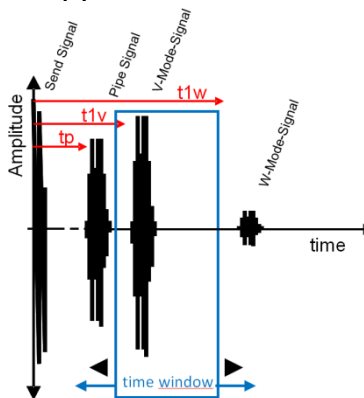

Figure 26: Signal decoupling through higher transducer frequency



The deltaxwaveC-F/P has very powerful signal unbundling algorithms. These are applied when you enable the Auto-Window function. Nevertheless, signal overlaps can occur, especially with very small pipes and/or unsafe pipe dimensions. In this case, the user can manually unbundle the signals in the oscilloscope window.

## 15.2.4 The Auto window function / AFC-Technology

The positioning of the ultrasonic transducers is essentially based on the basic data of the parameterization. This also means that a variable sound velocity of the medium flowing in the pipe would have to bring about a permanent repositioning of the ultrasonic transducers.

Practically speaking, this is relevant to:

- 1) Temperature variation: The sound velocity of a medium is temperature-dependent.
- 2) Medium change: Depending on the application it is possible that alternating different liquids are passed through the same pipeline.
- 3) Changes in concentration: Depending on the application, it is possible that concentration components will vary from the liquid component. This, albeit to a small extent, is caused by changes in sound velocity.

The algorithms of deltaxwaveC-F / P take into account the currently evaluated sound velocity for the calculation. This means that changes in the sound velocity as well as the invariable position of the ultrasonic transducers are iteratively taken into account in all subsequent calculations. This leads to a continuous correction of the variable boundary conditions "fluid" and is referred to **AFC technology (Automatic Fluid Control)**.

In general, it is not always useful to evaluate the total signal during ultrasonic measurements (interference signals, high memory requirements, high signal processing expenditure, and so on). The deltaxwaveC-F/P places a measuring window according to the parameterization in which the useful signal is expected (see 15.2). Only in this range is the signal recorded and evaluated.

All signals that appear in the measurement window are compared with the transmitted signal. If the signal pattern and coding match the transmitted signal, the signal is accepted as valid and a corresponding evaluation is carried out.

Variation properties of the liquid have not only effects on the calculations, but also on the position of the useful signal (valid receive signal) within the measurement window. A higher sound velocity means that the signal arrives earlier (shifting to the left on the time axis) a lower sound velocity is the opposite.

If these effects were not taken into account, the signal might migrate out of the evaluated measurement window in the event of a strong change in the liquid properties (medium change, temperature or concentration changes).

The **auto window function** cyclically checks the position of the useful signal in the measurement window and adjusts the measurement window position (if necessary, the adjustment of the delay value) to the current conditions.

**Optimal position** of time window:

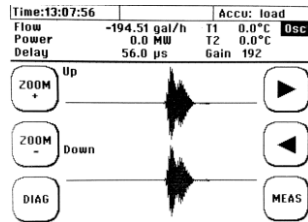

**Not optimal (BUT uncritical) position** of time window:

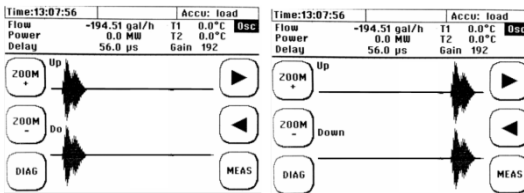

**Critical (incorrect) position** of time window:

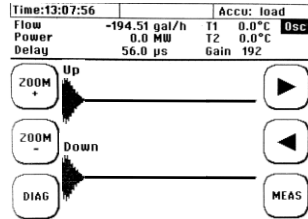

The Auto window function is activated and deactivated in the OSC window (see 15.1). The Auto window function status is displayed as a general header information.



An activated auto window function always tries to keep the measurement windows at the position calculated by deltaxwaveC-F/P as the ideal position. If you want to manually position the measurement window using the arrow keys in the OSZ window, you must deactivate the auto window function.



### 15.3 The diagnosis window of the deltaxwaveC-F/P

**Navigate to one of the measurement windows:**  
→ „DIAG“

The diagnose window gives an overview of all relevant application and signal parameters. As well relevant results of the signal processing are shown.

The function button above the OSC-button (mid button on the right side) can be used to switch between the 7 available send signal codes.

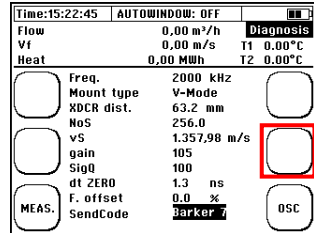

Parameter	Description
<b>Freq.</b>	Central frequency of the send signal: 500kHz (XUDC05), 1000kHz (XUDC10), 4000kHz (XUDC40)
<b>Mount type</b>	V-, W- or Z-mode (see 8.4.2)
<b>XDCR dist.</b>	Mounting distance between the transducer front areas
<b>NoS</b>	Number of Samples
<b>vS</b>	Sound velocity of the medium
<b>Gain</b>	Current gain of the received signal (see 15.1)
<b>SigQ</b>	Percentual amount of der prozentual of as valid recognised signal pairs. Typical value might be in the range 75-100%.
<b>dt ZERO</b>	Currently parameterized value of the ZERO point calibration (siehe 8.6)
<b>F.-Offset</b>	Shows the value currently parameterized for the flow offset (see 11.9.1).
<b>Send Code</b>	Encoding of the send signal. The send code can be changed manually. Following codes are available: „Burst9-9“, „Burst4“, „Barker5“, Barker7“, Barker8“, Barker11“ and „Barker15“, . By default, the deltaxwaveC-F/P uses Barker7 signal coding (factory setting).

## 15.4 What to do if the pipe is not fully filled?

If you cannot simply separate the piping (e.g. plastic piping) or if the application is in the planning or installation phase, it is recommended to use a siphon to compensate for partially filled piping. The gradient of the siphon is calculated based on the expected flow (flow velocity) and contamination load. Contact us for support if it is necessary to install a siphon for your application.

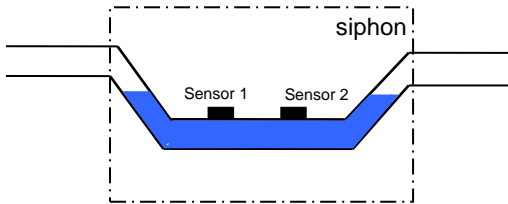

## Appendix A – Material data

**Table 1: Material data of different liquids: density  $\rho$ , kinematic viscosity  $\nu$  and sound velocity  $v_s$**

<b>Liquids</b>	<b>T [°C]</b>	<b><math>\rho</math> [g/cm<sup>3</sup>]</b>	<b><math>v_s</math> [m/s]</b>	<b><math>\nu</math> (10<sup>-6</sup> m<sup>2</sup>/s)</b>
acetone	20	0.7905	1190	0.407
aniline	20	1.0216	1659	1.762
alcohol	20	0.7893	1168	1.52
fuel	20	0.780	1280	0.35
chloroform	20	1.4870	1001	0.383
chlorobenzene	20	1.1042	1289	0.681
cyclohexane	20	0.779	1284	1.256
deuterium oxide	20	1.1053	1388	1.129
diesel	20	0.850	1250	0.40
acetic acid	20	1.0495	1159	1.162
ether	20	0.7135	1006	0.336
ethyl acetate	20	0.900	1164	0.499
ethylene glycol	20	1.1131	1666	21.112
glycerine	20	1.2613	1923	1188.5
methyl acetate	20	0.928	1181	0.411
nitrobenzene	20	1.207	1473	1.665
n-hexane	20	0.654	1083	0.489
n-pentane	20	0.6260	1032	0.366
n-propanol	20	0.8038	1255	2.861
n-octane	20	0.7021	1192	0.538
O-xylene	15	0.883	1360	0.917
oil (transformer)	20	0.895	1425	12 (40°C)
oil (spindle)	20	0.871	1342	30-73 (40°C)
petroleum	34	0.825	1295	2
mercury	20	13.5955	1451	0.114
carbon disulphide	20	1.2634	1158	0.290
carbon tetrachloride	20	1.5942	938	0.608
water	20	0.9982	1483	1.004
seawater (salt content: 3.5%)	16	1.000	1510	1.360

**Table 2: Sound velocities of water as a function of the medium temperature (0 to 100°C)**

T [°C]	v [m/s]	T [°C]	v [m/s]	T [°C]	v [m/s]	T [°C]	v [m/s]
0	1402.74						
1	1407.71	26	1499.64	51	1543.93	76	1555.40
2	1412.57	27	1502.20	52	1544.95	77	1555.31
3	1417.32	28	1504.68	53	1545.92	78	1555.18
4	1421.98	29	1507.10	54	1546.83	79	1555.02
5	1426.50	30	1509.44	55	1547.70	80	1554.81
6	1430.92	31	1511.71	56	1548.51	81	1554.57
7	1435.24	32	1513.91	57	1549.28	82	1554.30
8	1439.46	33	1516.05	58	1550.00	83	1553.98
9	1443.58	34	1518.12	59	1550.68	84	1553.63
10	1447.59	35	1520.12	60	1551.30	85	1553.25
11	1451.51	36	1522.06	61	1551.88	86	1552.82
12	1455.34	37	1523.93	62	1552.42	87	1552.37
13	1459.07	38	1525.74	63	1552.91	88	1551.88
14	1462.70	39	1527.49	64	1553.35	89	1551.35
15	1466.25	40	1529.18	65	1553.76	90	1550.79
16	1469.70	41	1530.80	66	1554.11	91	1550.20
17	1473.07	42	1532.37	67	1554.43	92	1549.58
18	1476.35	43	1533.88	68	1554.70	93	1548.92
19	1479.55	44	1535.33	69	1554.93	94	1548.23
20	1482.66	45	1536.72	70	1555.12	95	1547.50
21	1485.69	46	1538.06	71	1555.27	96	1546.75
22	1488.63	47	1539.34	72	1555.37	97	1545.96
23	1491.50	48	1540.57	73	1555.44	98	1545.14
24	1494.29	49	1541.74	74	1555.47	99	1544.29
25	1497.00	50	1542.87	75	1555.45	100	1543.41

T: temperature, v: sound velocity

**Table 3: Material data of different pipe and liner materials: longitudinal sound velocity  $v_P$  and Poisson's ratio  $\nu$**

Material	$v_P$ [m/s]	$\nu$ [unit less]
Carbon steel	5890	0.2831
Stainless steel	5660	0.2818
Copper (rolled)	3700-3850	0.3462
Copper (cast)	4660	0.3462
Cast iron	4600	0.2653
Titanium	6100	0.3229
Aluminium	6196	0.3316
Glass	5640	0.2445
Lead	2170	0.4410
Brass (70-30)	4700	0.3750
Cement	4190	0.2022
Tar	2540	0.2322
Porcelain	4800	0.2832
Teflon (PTFE)	1350	0.4048
Rubber	1800	0.1932
Plastic	2300	0.3517
FRP (Fiber Reinforced Plastic)	2505	0.3-0.6

**Table 4: Typical material data of varying plastic materials: longitudinal sound velocity  $v_P$  and Poisson's ratio  $\nu$**

Material	$v_P$ [m/s]	$\nu$ [unit less]
PVC	2380	0.4004
PE HD	2430	0.4075
PE LD	1950	0.4568
Teflon (PTFE), ETFE, FEP	1350	0.4048
PP	2660	0.4516
PVDF	2300	0.3372
Polyamide (PA / Nylon)	2582	0.3960
Polycarbonate (PC)	2286	0.3700
PET (Mylar, Polyethylene Terephthalate)	2540	0.3800
PMP (Polymethylpenten)	2180	0.3374
POM (Polyoxymethylen)	2470	0.3972
PS (Polystyrene)	2400	0.3510
PSU (Polysulfone)	2240	0.3700
SAN (Styrol-Acrylnitril, Lustran)	2510	0.33-0.36
EPDM (Rubber)	1450	0.3000
NBR (Nitrile Butadiene Rubber)	1500	0.48-0.496

## Appendix B – Technical data

<b>Method</b>	<b>Transit time (ultrasound)</b>
<b>Measured variables</b>	flow velocity, volume flow, heat (opt.), mass flow
<b>Counter</b>	heat, volume, total mass
<b>Measurement range</b>	-30...+30 m/s
<b>Languages</b>	EN-DE-FR; EN-ES-FR; EN-RU-CH
<b>Units</b>	metric, imperial
<b>Handling</b>	Intuitive via 8 soft keys
<b>Operating temperature</b>	-20...60°C
<b>Power consumption</b>	approx. 10 W
<b>Integrated data memory</b>	Micro-SD Card, 4 GB (other sizes possible)
<b>Display</b>	LCD 320x240 (Backlight: LED, dimmable)
<b>Signal damping</b>	0...60 sec (adjustable)
<b>Diagnose functions</b>	Sound velocity, signal strength, SNR, signal quality, amplitude, energy, signals can be displayed graphically

	<b>deltawaveC-F</b>	<b>deltawaveC-P</b>
<b>Power supply</b>	90-264VAC 18-36VDC (opt.)	Input: 100-240 V/AC Output: 19 V/DC (max. 3,42 A) Li-Ion – accumulator pack: battery longevity: approx. 22 h
<b>International Protection Marking</b>	IP65	IP40
<b>Housing</b>	Stainless steel, wall mounting	Aluminium (portable)
<b>Weight (kg)</b>	4.1	1.5
<b>Size (WxHxD, mm)</b>	360 x 290 x 82	265 x 190 x 70
<b>Inputs</b>	2x Pt100 (3-wire) 2x 4...20mA (active/passive, optional)	2x Pt100 (3- wire)
<b>Outputs</b> (not potential-free, exception: relay of deltaxwaveC-P)	1x USB-jack (Mini B) 2x transducer (2CH : 4x) 2x 4...20mA (active/passive) 1x Pulse (2CH : 2x) 1x Relay (max 50V; 0.5A) RS232/RS485 (optional)	1x USB- jack (Mini B) 2x transducer (BNC, 50 Ohm) 2x 4-20mA (active/passive) 1x Pulse (open collector, passive) 1x Relay (normally open, potential free) (max 50V; 0.5A)

### Ultrasonic transducer

Type	Pipe diameter	Temperature
F40 (4 MHz)	DN10...DN100	-40...150°C
F10 (1 MHz)	DN32...DN400	-40...150°C
F05 (500 kHz)	DN200...DN6000	-40...150°C
HAT XDR 500 (1MHz)	DN25...DN400	-55...380°C

Pipe diameter / flow velocity	Measurement accuracy
10-25mm	+/- 0.05 m/s
0...2 m/s	
2...30 m/s	2.5% of measurement reading
25 – 50 mm	+/- 0.03 m/s
0...2 m/s	
2...30 m/s	1.5% of measurement reading
50 – 300 mm	+/- 0.02 m/s
0...2 m/s	
2...30 m/s	1% of measurement reading
300 – 6000 mm	+/- 0.02 m/s
0...2 m/s	
2...30 m/s	1% of measurement reading

## Appendix C – Modbus register overview

The total Input Register size is 125 double words (250 byte). The MODBUS register address will start from 0 up to 124. In the current status, only the first 25 double words contain valid values (31 double words for 2-channel).

1 channel device (Big Endian) dwc-f Software 3.xx.xx



Parameter	Input Register Address (Hex)	Input Registers (Size)	Format (Big Endian)
Flow	0x0000 - 0x0001	2	Float AB CD
Flow Unit Code	0x0002	1	unsigned
Fluid velocity	0x0003 - 0x0004	2	Float AB CD
Sonic velocity	0x0005 – 0x0006	2	Float AB CD
Fluid velocity Unit Code	0x0007	1	unsigned
Total Flow	0x0008 - 0x0009	2	Float AB CD
Total Flow Unit Code	0x000A	1	unsigned
<b>Thermal output</b>	0x000B – 0x000C	2	Float AB CD
<b>Thermal output Unit Code</b>	0x000D	1	unsigned
Heat quantity	0x000E – 0x000F	2	Float AB CD
Heat quantity Unit Code	0x0010	1	unsigned
Analog Input A	0x0011 – 0x0012	2	Float AB CD
Analog Input B	0x0013 – 0x0014	2	Float AB CD
Temperature A	0x0015 – 0x0016	2	Float AB CD
Temperature B	0x0017 – 0x0018	2	Float AB CD
Temperature differential	0x0019 – 0x001A	2	Float AB CD
Temperature differential Unit Code	0x001B	1	unsigned
Mass	0x001C – 0x001D	2	Float AB CD
Mass Unit Code	0x001E	1	unsigned
Mass Flow	0x001F – 0x0020	2	Float AB CD
Mass Flow Unit Code	0x0021	1	unsigned
Signal Quality	0x0022 – 0x0023	2	Float AB CD
device status text code	0x0024	1	unsigned
Total Heat positive	0x0025 – 0x0026	2	Float AB CD
Total Heat negative	0x0027 – 0x0028	2	Float AB CD
Reserve	0x0029 - 0x007C	83(0x5A)	

For further information, see "**Supplementary Manual deltaxwaveC-F MODBUS**".



2 channel device (Big Endian) dwc-f Software 3.xx.xx



Parameter	Input Register Adresse (Hex)	Count of input Register (Decimal)	Format (Big Endian)
<b>Flow CH1</b>	0x0000 – 0x0001	2	Float AB CD
<b>Flow CH2</b>	0x0002 – 0x0003	2	Float AB CD
<b>Flow Unit Code</b>	0x0004	1	unsigned
<b>Fluid velocity CH1</b>	0x0005 – 0x0006	2	Float AB CD
<b>Fluid velocity CH2</b>	0x0007 – 0x0008	2	Float AB CD
<b>Sonic velocity CH1</b>	0x0009 – 0x000A	2	Float AB CD
<b>Sonic velocity CH2</b>	0x000B – 0x000C	2	Float AB CD
<b>Fluid velocity Unit Code</b>	0x000D	1	unsigned
<b>Total flow CH1</b>	0x000E – 0x000F	2	Float AB CD
<b>Total flow CH2</b>	0x0010 – 0x0011	2	Float AB CD
<b>Total flow Unit Code</b>	0x0012	1	unsigned
<b>Thermal output (CH1+CH2)/2</b>	0x0013 – 0x0014	2	Float AB CD
<b>Thermal output Unit Code</b>	0x0015	1	unsigned
<b>Heat quantity (CH1+CH2)/2</b>	0x0016 - 0x0017	2	Float AB CD
<b>Heat quantity Unit Code</b>	0x0018	1	unsigned
Analoge Input A	0x0019 - 0x001A	2	Float AB CD
Analoge Input B	0x001B – 0x001C	2	Float AB CD
<b>Temperature A</b>	0x001D - 0x001E	2	Float AB CD
<b>Temperature B</b>	0x001F - 0x0020	2	Float AB CD
<b>Temperature differential</b>	0x0021 – 0x0022	2	Float AB CD
<b>Temperature differential Unit Code</b>	0x0023	1	unsigned
Mass	0x0024 - 0x0025	2	Float AB CD
<b>Mass Unit Code</b>	0x0026	1	unsigned
Mass Flow	0x0027 - 0x0028	2	Float AB CD
<b>Mass Flow Unit Code</b>	0x0029	1	unsigned
Signal <b>quality</b> CH1	0x002A - 0x002B	2	Float AB CD
Status CH1	0x002C	1	unsigned
Signal <b>quality</b> CH2	0x002D - 0x002E	2	Float AB CD
Status CH2	0x002F	1	unsigned
Reserve	0x0040 – 0x007C	56(0x58)	

For further information, see "**Supplementary Manual deltaxwaveC-F MODBUS**".

## Appendix D – Transducer type overview

### deltawaveC-F



#### XUC-FW F40 (4 MHz)

Pipe diameter: DN10...DN100  
Temperature: -40°C...150°C



#### XUC-FW F10 (1 MHz)

Pipe diameter: DN32...DN400  
Temperature: -40°C...150°C



### deltawaveC-P



#### XUC-PW F40 (4 MHz)

Pipe diameter: DN10...DN100  
Temperature: -40°C...150°C



#### XUC-PW F10 (1 MHz)

Pipe diameter: DN32...DN400  
Temperature: -40°C...150°C



**XUC-FW F05 (0,5 MHz)**

Pipe diameter: DN200...DN6000  
Temperature: -40°C...150°C



**XUC-PW F05 (0,5 MHz)**

Pipe diameter: DN200...DN6000  
Temperature: -40°C...150°C



**HT XDR 500 (1 MHz)**  
Pipe Diameter: DN25...DN400  
Temperature: -55...380°C



## Appendix E – Mounting equipment and accessories

### Mounting rail for ultrasonic transducer



mounting rail		transducer compatibility	
		F10	F40
<b>SHORT</b>	length: 25 cm; Hole grid increment: 7,5 mm		X
<b>LONG</b>	length: 40 cm; Hole grid increment : 15 mm	X	

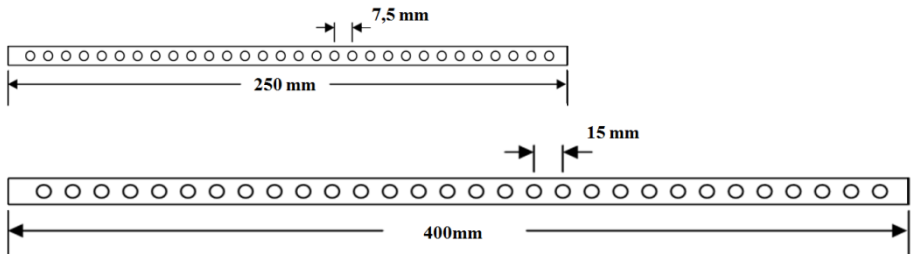

**Figure 27:** Mounting rail; top: "short", below: "long"



The **"long"** rail is exclusively compatible with the ultrasonic transducer type **F10**, not with F40!  
The ultrasonic transducer type F05 is mounted on the pipe without a rail by means of a textile or stainless steel belt.

### Mounting accessories:

deltawaveC-F	
XUC-FW05	Stainless steel tensioning straps of various lengths (included in the standard scope of delivery)
XUC-FW10	
XUC-FW40	
PT100	
deltawaveC-P	
XUC-PW F05	Textile tension band
XUC-PW F10	Mounting chain
XUC-PW F40	Velcro tension band
PT100	Velcro tension band

## Ultrasonic coupling gel



deltawaveC-F	
Standard:	Acoustic coupling pads for permanent installation
Optional:	Ultrasonic coupling gel Magnalube: Better signal coupling, must be renewed regularly for permanent installation.

deltawaveC-P	
Standard:	Ultrasound coupling gel Magnalube (can be obtained from systec Controls under the designation "Magnalube" if required)

## USB-connection cable



Included in deltaxwaveC-P purchased parts package.



Connection cable for SD memory card access.

USB 2.0  
Type A plug to  
Mini B (5 Pin) plug

## Accessories for deltaxwaveC-P



Included in deltaxwaveC-P purchased parts package:

- 2 BNC measuring leads (blue/red)
- Power supply unit (19 V, 3.42 A)
- Analogue output cable (4 crocodile clips)
- Connection cable for potential-free relay and pulse output (4 crocodile clips)

## Wiring diagram (pin assignment) deltaxwaveC-P

4-20 mA analog output cable (4 crocodile clamps)



Current direction is from IxB to IxA

pin 2 – red	I1B (output 1)
pin 3 – black	I1A (output 1)
pin 4 – white	I2B (output 2)
pin 5 – green	I2A (output 2)

Connection cable for potential-free relay and pulse output (4 crocodile clamps)

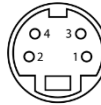

pin 1 – green	relay A
pin 2 – yellow	relay B
pin 3 – black	pulse (-)
pin 4 – red	pulse (+)

## Pt100 Temperature sensor



Optional accessories for determination of heat.



**Figure 28:** Pt100 contact temperature sensor for heat quantity measurement

Mini-DIN-Plug 6-pol.	Colour of wire	PT100 Num. 1	PT100 Num. 2
PIN 1	black	red	
PIN 2	brown		red
PIN 3	red	white	
PIN 4	orange		white
PIN 5	yellow	white	
PIN 6	green		white

View solder side:

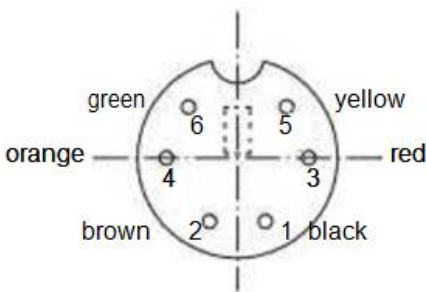

View plug-in page:

